

# NEWALL

## DP1200 Digital Readout



## User Manual

### SALES & SERVICE:

**A Tech Authority, Inc.**  
13745 Stockton Ave.  
Chino CA 91710  
909-614-4522  
sales@atechauthority.com

# Contents

<b>Specification</b> .....	<b>Page 3</b>		<b>Setup Axis 4 (Digital Rotary Angular) continued</b>	
Electrical	Page 3		Angular Display Setup	Page 21
Physical	Page 3		Angle Mode Setup	Page 21
Environment	Page 3		Direction Setup	Page 21
Accreditation	Page 3		Signal Checking Setup	Page 21
Disposal	Page 3		Zero Approach Setup	Page 21
Input and Resolution	Page 3			
<b>Mounting Options</b> .....	<b>Page 4</b>		<b>Setup Axis 4 (Digital Rotary Linear)</b>	<b>Page 22</b>
Mill Mount	Page 4		Legend Setup	Page 22
Lathe Mount	Page 4		Encoder Setup	Page 22
Adjustable Mount	Page 4		Reference Source Setup	Page 22
Panel Mount	Page 4		Encoder Resolution Setup	Page 22
			Display Resolution Setup	Page 23
			Direction Setup	Page 23
<b>Connection Details</b> .....	<b>Page 5</b>		Radius / Diameter (Measure Setup)	Page 23
Important Information	Page 5		Signal Checking Setup	Page 23
Connections	Page 5		Zero Approach Setup	Page 23
			Error Compensation Setup	Page 23
<b>Display and Keypad</b> .....	<b>Page 6</b>		<b>General Setup</b>	<b>Page 24</b>
Understanding the Display	Page 6		Language Setup	Page 24
Understanding the Keypad	Page 6		Application Setup	Page 24
Invalid Key Warning	Page 6		Plane Setup	Page 24
			Axis Coupling Setup	Page 24
<b>Setting up the Unit</b> .....	<b>Page 7</b>		Functions Setup	Page 25
Setup Menu Navigation	Page 7		Probe Diameter Setup	Page 25
Navigating Axes 1, 2, 3, 4 (Analogue) Setup	Page 7		Beep Setup	Page 25
Quick Navigation Axes 1, 2, 3, 4 (Analogue) Setup	Page 7		LCD Brightness Setup	Page 25
Navigating Axis 4 Setup (Digital Linear)	Page 8		Sleep Setup	Page 26
Quick Navigation of Axis 4 Setup (Digital Linear)	Page 8		Unlock Axis	Page 26
Navigating Axis 4 Setup (Digital Rotary Angular)	Page 9		Reset Setup	Page 26
Quick Navigation of Axis 4 Setup (Digital Rot Ang)	Page 9			
Navigating Axis 4 Setup (Digital Rotary Linear)	Page 10		<b>Standard Functions</b> .....	<b>Page 27</b>
Quick Navigation of Axis 4 Setup (Digital Rot Lin)	Page 10		Absolute / Incremental	Page 27
Navigating General Setup	Page 11		Inch / mm	Page 27
Quick Navigation of General Setup	Page 11		Zero and Preset an Axis	Page 28
			Undo Function	Page 28
<b>Setup Axis 1, 2, 3 &amp; 4 (Analogue)</b>	<b>Page 12</b>		Half Function / Centre Find	Page 29
Legend Setup	Page 12		Digifind / Reference	Page 29
Encoder Setup	Page 12		Sub Datums / Memory (SDM)	Page 30/31
Display Resolution Setup	Page 12		Sleep Mode	Page 31
Direction Setup	Page 12		RS232 (Data Logging) / Data Acquisition	Page 32
Radius / Diameter (Measure Setup)	Page 12		RS232 Connections	Page 32
Zero Approach Setup	Page 13		RS232 Setup	Page 32/33
Error Compensation	Page 13		RS232 Output Data Format	Page 34
Types of Machine Error	Page 14			
Linear Error Compensation	Page 14		<b>Mill Functions</b> .....	<b>Page 35</b>
Error Compensation Setup	Page 15		PCD / Bolt Hole Circle	Page 35/36
Linear Error Compensation Setup	Page 15		Line Hole	Page 37/38
Segmented Error Compensation	Page 16		Arc Contouring	Page 39/40
Segmented Error Compensation Setup	Page 16/17		Polar Coordinates	Page 41
			Skew	Page 42/43
<b>Setup Axis 4 (Digital Linear)</b>	<b>Page 18</b>			
Legend Setup	Page 18		<b>Lathe Functions</b> .....	<b>Page 44</b>
Encoder Setup	Page 18		Tool Offsets	Page 44/45
Reference Source Setup	Page 18		Vector	Page 46
Encoder Resolution Setup	Page 18		Taper Angle	Page 47
Display Resolution Setup	Page 18		Axis Summing	Page 48
Direction Setup	Page 19			
Radius / Diameter (Measure Setup)	Page 19		<b>Troubleshooting Guide</b> .....	<b>Page 49</b>
Signal Checking Setup	Page 19			
Zero Approach Setup	Page 19			
Error Compensation Setup	Page 19			
<b>Setup Axis 4 (Digital Rotary Angular)</b>	<b>Page 20</b>			
Legend Setup	Page 20			
Encoder Setup	Page 20			
Reference Source Setup	Page 20			
Encoder Resolution Setup	Page 20			

# Specification

3

## Electrical

EU Directive 73/23/EEC (Low Voltage Directive)  
BS EN 55022:1998 Class B  
BS EN 55024:1998

Input to Power Supply Unit (Supplied)  
100-240V (47-63Hz)  
External switch-mode - Output voltage 15VDC  
Input Voltage to DP1200 15-24VDC  $\pm 10\%$   
Conforms to Low Voltage Directive

## Physical

Height	215mm (8 ½")	Depth	68mm (2 ¾")
Width	310mm (12 ¼")	Weight	3.5kg (7 ¾lb)

## Environment

Climatic Range	Storage Temperature	-20°C (-4°F) to 70°C (158°F)
	Working Temperature	-10°C (14°F) to 50°C (122°F)
	Working Humidity	95% R.H. at 31°C (87.8°F)

IP-Ingress Protection	IP54 Panel Mount
	IP40 Stand Alone

## Accreditation



## Disposal

At the end of its life, you should dispose of the DP1200 system in a safe manner applicable to electrical goods

Do not burn

The casework is suitable for recycling. Please consult local regulations on disposal of electrical equipment

## Input & Resolutions

Encoder inputs 1, 2 & 3 can be used with Spherosyn 2G and Microsyn 2G analogue encoders. Encoder input 4 can be used with Spherosyn 2G / Microsyn 2G or 5v TTL Quadrature, depending on the model ordered.

**Note:** It is possible to upgrade the DP1200 from a 2 or 3 Axis up to 4 Axes, See Page 26 - Unlock Axis.

## Display Resolution Options

### Spherosyn 2G or Microsyn 2G 10µm

5µm (0.0002")  
10µm (0.0005")  
20µm (0.001")  
50µm (0.002")

### Microsyn 2G 5µm

1µm (0.00005")  
2µm (0.0001")  
5µm (0.0002")  
10µm (0.0005")

Newall Measurement Systems Limited reserves the right to make changes to this specification without notice

# Mounting Options

This section details the various mounting options for the DP1200, both the standard version and the panel mount version.

## Mill Mount (Non Adjustable)

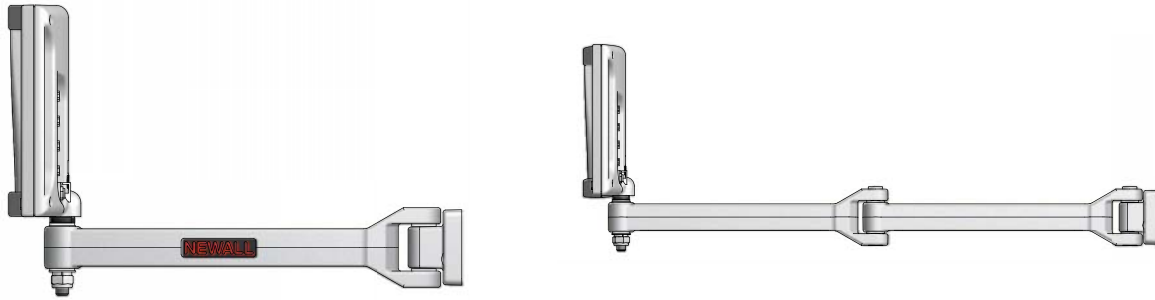

## Lathe Mount (Non Adjustable)



## Adjustable Mount Options

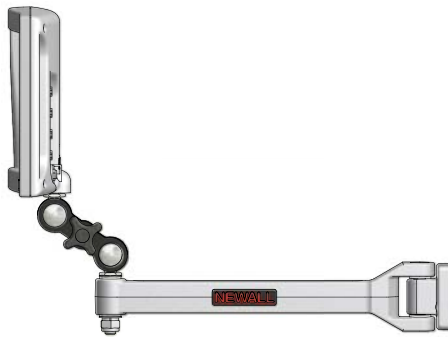

## Panel Mount Option

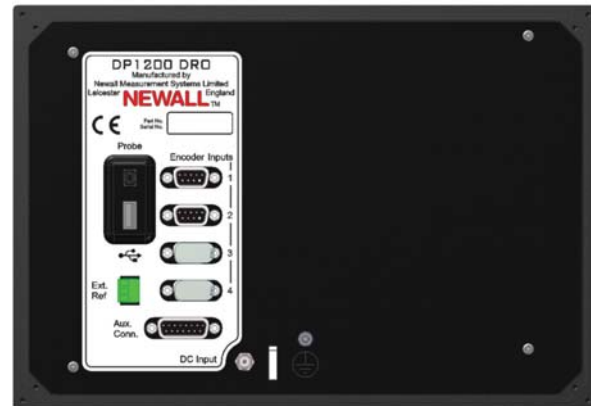
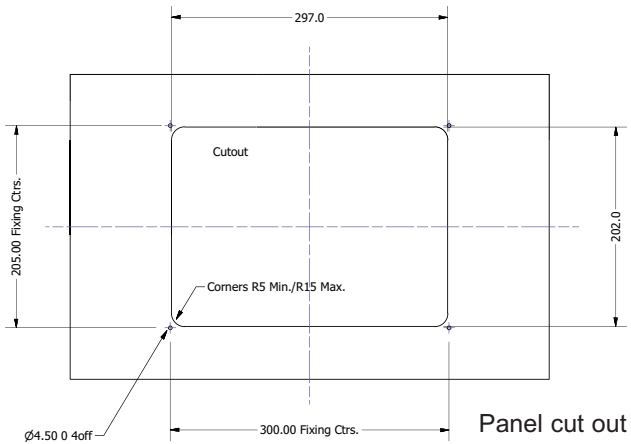

# Connection Details

This chapter details the cable connections for the DP1200.

## Important Information

Encoder inputs 1, 2 & 3 can be used with Spherosyn 2G and Microsyn 2G analogue encoders. Encoder input 4 can be used with Spherosyn 2G / Microsyn 2G or 5v TTL Quadrature, depending on the model ordered.

Please ensure that:

- ✓ All cables are secured to prevent the connectors from dropping into hazardous positions (for example the floor or coolant tray) when unplugged.
- ✓ All cables are routed to prevent them from being caught on moving parts.
- ✓ Before the machine power is turned on, the DP1200 is grounded to the machine, using the braided grounding lead provided.
- ✓ The power has been disconnected, before you connect the encoder(s).

**⚠ DO NOT CONNECT THIS UNIT DIRECTLY TO THE MAINS SUPPLY.**

If the Newall encoder has a round 7 pin connector, an adaptor cable (part no. 307-80980) is required. Contact your local Newall supplier for details.

## Connections

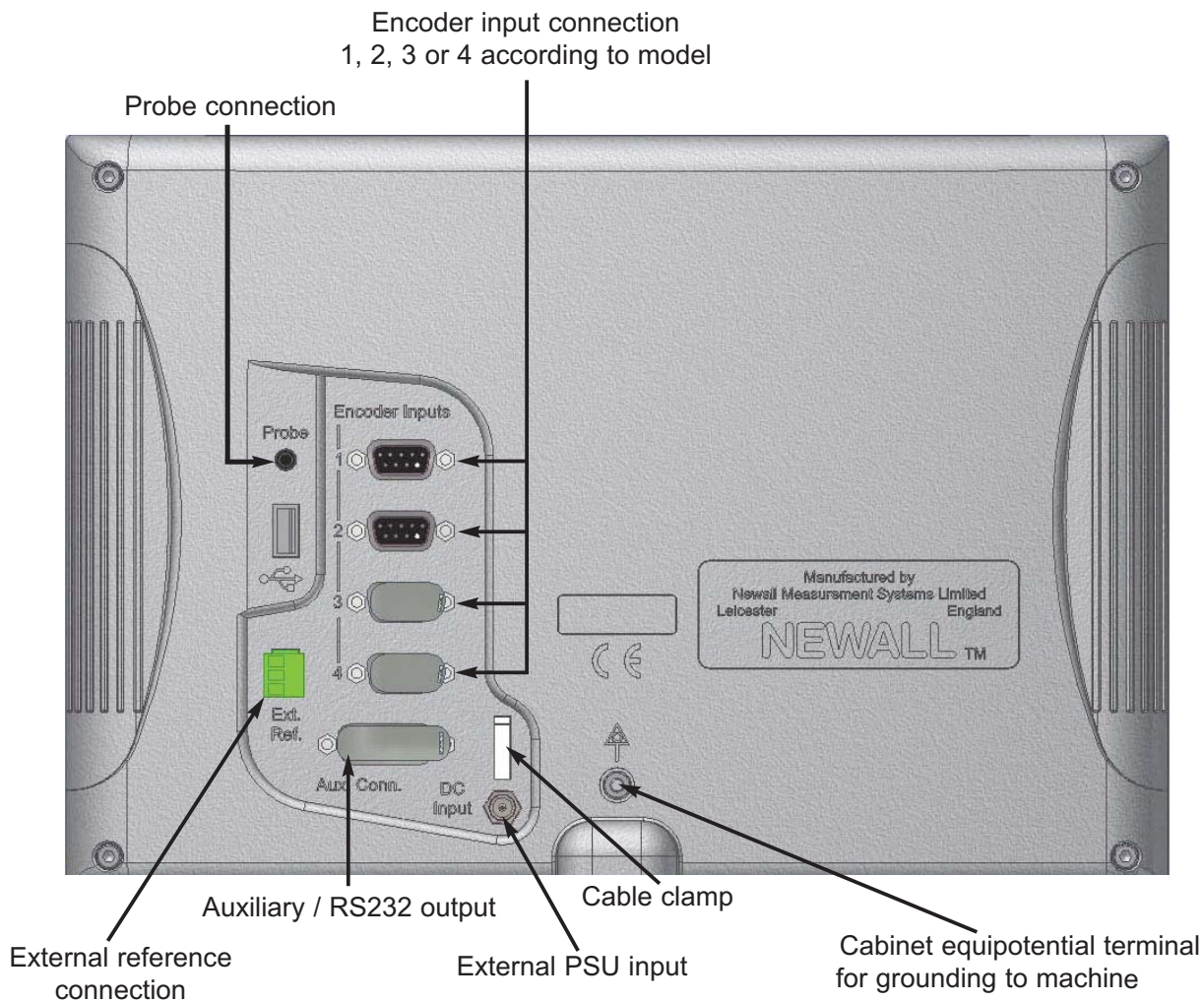

# Display and Keypad

This section explains how to interpret the display and use the keypad.

## Understanding The Display



## Understanding The Keypad

	Axis Selection Key		Digifind / Reference
	Numeric Keys		Switches between Zero and Axis Preset modes
	Enter Key		Switches between Absolute and Incremental modes
	Clear Numeric Entry		Switches between Inch and mm display
	Centre Find		Soft Keys (left, middle & right)
	Undo Key		Navigation Keys
			Sleep Key

## Invalid Key Warning

The DP1200 is equipped with a visual and audible indication to warn the user when an invalid key has been pressed.

If an invalid key has been pressed, all the displays will flash on and off twice along with a double beep tone. No operation will change until a correct key for that operation has been pressed.

# Setting Up The Unit

## Setup Menu Navigation

How to enter setup

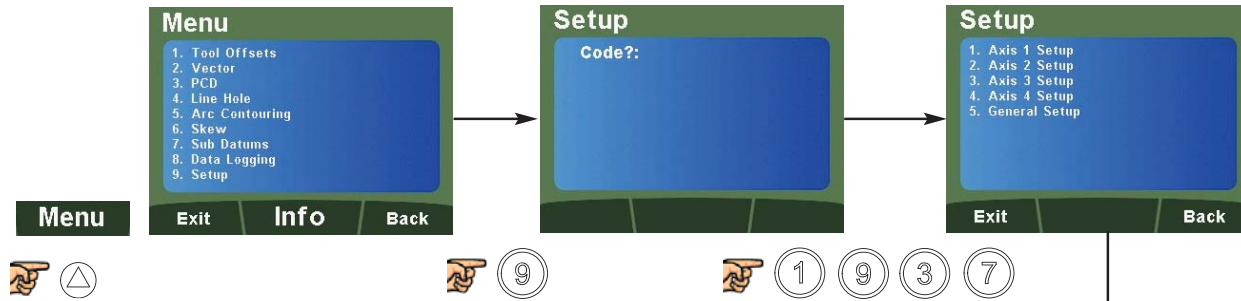

## Navigating Axes 1, 2, 3 & 4 (Analogue) Setup

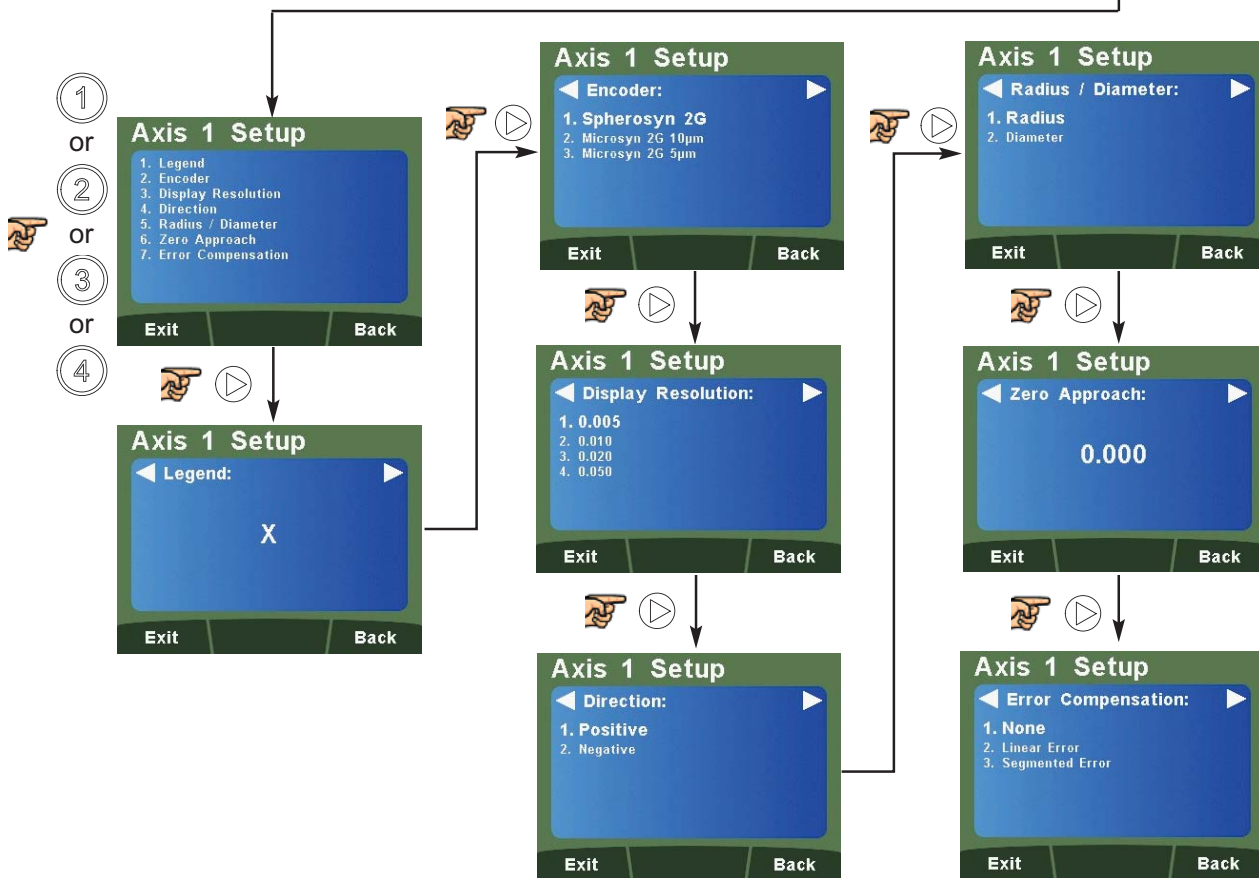

## Quick Navigation of Axes 1, 2, 3 & 4 (Analogue) Setup

The DP1200 supports a quick navigation feature using the LCD screen and numeric keys, enabling the user to navigate to specific areas without scrolling through each and every menu. This is particularly useful when navigating to one specific item.

Below are the quick navigation keys for the setup of Axes 1, 2, 3 or 4 dependant on model (where navigation to the main axis setup menu is completed).

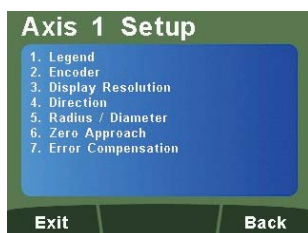

Numeric Key	Setup Function
1	Legend Setup
2	Encoder Setup
3	Display Resolution Setup
4	Direction Setup
5	Radius / Diameter Setup
6	Zero Approach Setup
7	Error Compensation Setup

# Setting Up The Unit

## Setup Menu Navigation (continued)

### Navigating Axis 4 Setup (Digital Linear)



## Quick Navigation of Axis 4 Setup (Digital Linear)

The quick navigation feature for the setup of axis 4 digital linear is detailed below (where navigation to the main axis setup menu is completed).

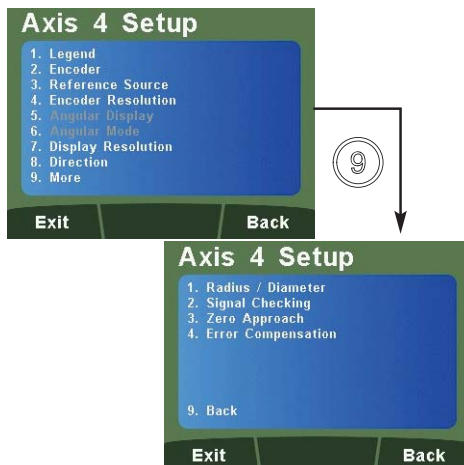

Numeric Key	Setup Function
1	Legend Setup
2	Encoder Setup
3	Reference Source Setup
4	Resolution Setup
7	Display Resolution Setup
8	Direction Setup
9	More Options
<b>Press Key 9 for the options below</b>	
1	Radius / Diameter Setup
2	Signal Checking Setup
3	Zero Approach Setup
4	Error Compensation Setup
9	Back to Previous Options



# Setting Up The Unit

## Setup Menu Navigation (continued)

### Navigating Axis 4 Setup (Digital Rotary Angular)

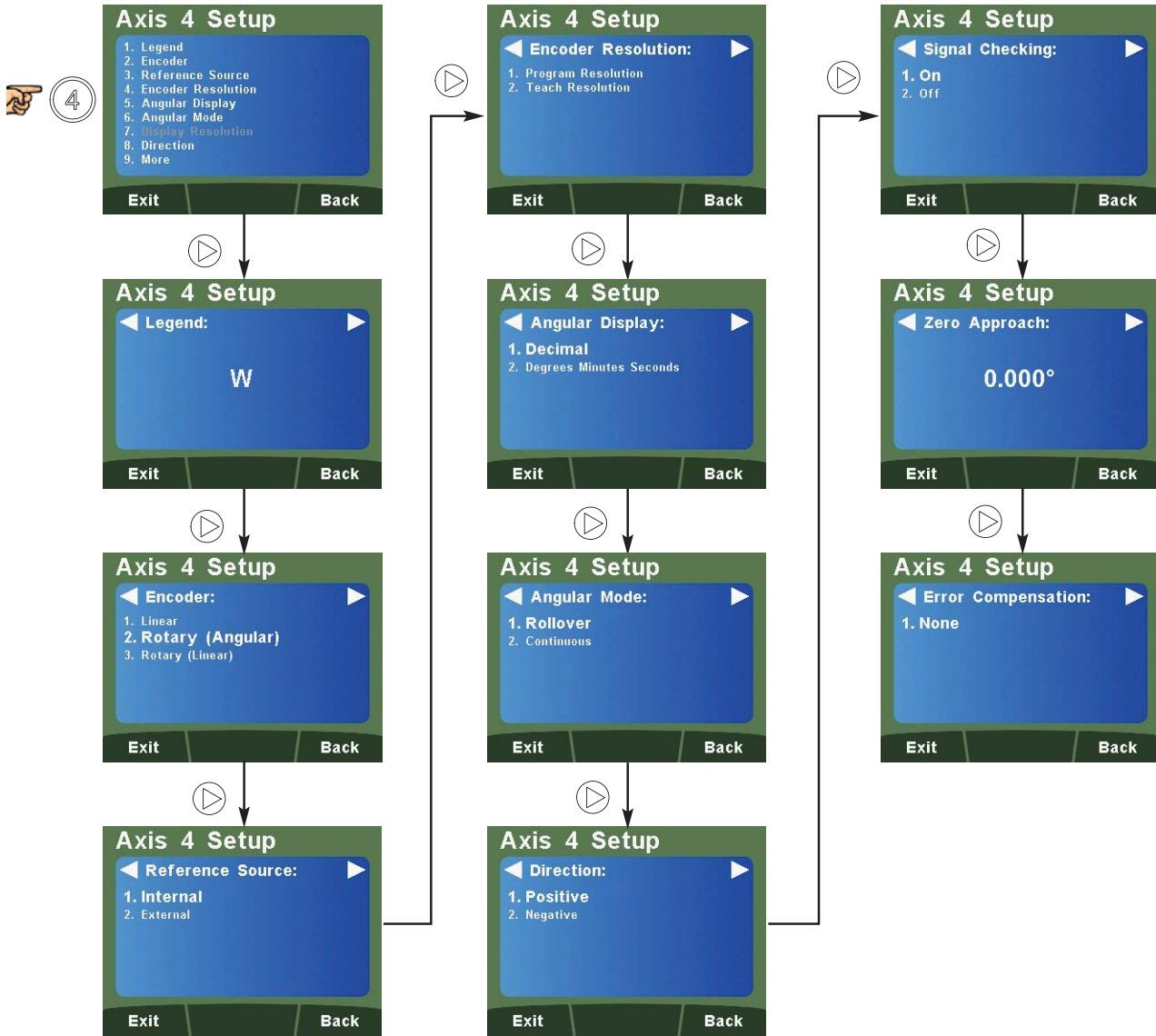

## Quick Navigation of Axis 4 Setup (Digital Rotary Angular)

The quick navigation feature for the setup of axis 4 digital rotary angular is detailed below (where navigation to the main axis setup menu is completed).

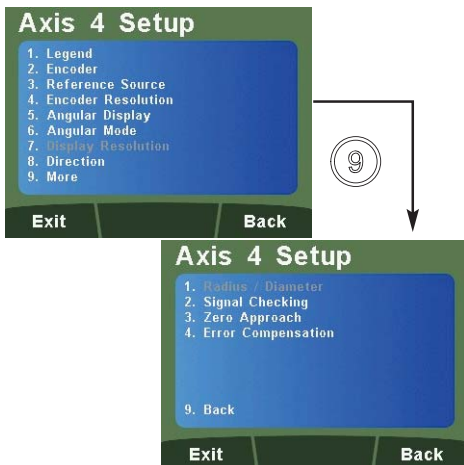

Numeric Key	Setup Function
1	Legend Setup
2	Encoder Setup
3	Reference Source Setup
4	Resolution Setup
5	Angular Display Setup
6	Angular Mode Setup
8	Direction Setup
9	More Options
<b>Press Key 9 for the options below</b>	
2	Signal Checking Setup
3	Zero Approach Setup
4	Error Compensation Setup
9	Back to Previous Options

# Setting Up The Unit

## Setup Menu Navigation (continued)

### Navigating Axis 4 Setup (Digital Rotary Linear)



## Quick Navigation of Axis 4 Setup (Digital Rotary Linear)

The quick navigation feature for the setup of axis 4 digital rotary linear is detailed below (where navigation to the main axis setup menu is completed).

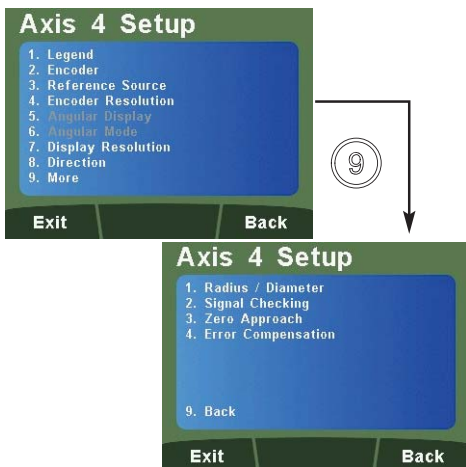

Numeric Key	Setup Function
1	Legend Setup
2	Encoder Setup
3	Reference Source Setup
4	Resolution Setup
7	Display Resolution Setup
8	Direction Setup
9	More Options
<b>Press Key 9 for the options below</b>	
1	Radius / Diameter Setup
2	Signal Checking Setup
3	Zero Approach Setup
4	Error Compensation Setup
9	Back to Previous Options

# Setting Up The Unit

## Setup Menu Navigation (continued)

### Navigating General Setup



### Quick Navigation of General Setup

The quick navigation feature for general setup is detailed below (where navigation to the main axis setup menu is completed).

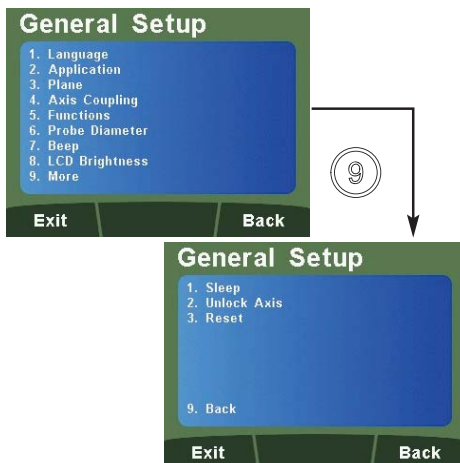

Numeric Key	Setup Function
1	Language Setup
2	Application Setup
3	Plane Setup
4	Mill Summing Setup
5	Functions Setup
6	Probe Diameter Setup
7	Beep Setup
8	LCD Brightness Setup
9	More Options
<b>Press Key 9 for the options below</b>	
1	Sleep Setup
2	Unlock Axis
3	Reset Setup
9	Back to Previous Options

# Setting Up The Unit

## Setup Axis 1, 2, 3 & 4 (Analogue)

### Legend Setup

The legend of the axis can be set to any of the options in the table below.

Navigate to



Use the key list to select the desired character

Key	1 <sup>st</sup> Press	2 <sup>nd</sup> Press	3 <sup>rd</sup> Press	4 <sup>th</sup> Press	5 <sup>th</sup> Press
0	0	N/A	N/A	N/A	N/A
1	X <sup>1</sup>	Y <sup>1</sup>	Z <sup>1</sup>	1	N/A
2	A	B	C	2	N/A
3	D	E	F	3	N/A
4	G	H	I	4	N/A
5	J	K	L	5	N/A
6	M	N	O	6	N/A
7	P	Q	R	S	7
8	T	U	V	8	N/A
9	W	X	Y	Z	9

### Encoder Setup

Navigate to

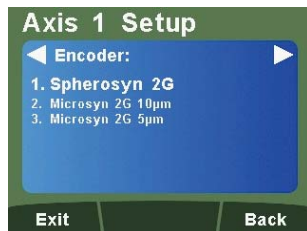

- ① To select **Spherosyn 2G** as the encoder type
- ② To select **Microsyn 2G 10µm** as the encoder type
- ③ To select **Microsyn 2G 5µm** as the encoder type

**Note:** The encoder type must match the actual encoder in use, or the DP1200 will not display correctly

### Display Resolution Setup

Navigate to



- | <u>Spherosyn 2G &amp; Microsyn 2G 10µm</u> | <u>Microsyn 2G 5µm</u>            |
|--|-----------------------------------|
| ① To select <b>5µm (0.0002")</b>           | ① To select <b>1µm (0.00005")</b> |
| ② To select <b>10µm (0.0005")</b>          | ② To select <b>2µm (0.0001")</b>  |
| ③ To select <b>20µm (0.001")</b>           | ③ To select <b>5µm (0.0002")</b>  |
| ④ To select <b>50µm (0.002")</b>           | ④ To select <b>10µm (0.0005")</b> |

### Direction Setup

Navigate to



- ① To select **Positive**
- ② To select **Negative**

#### Example:

If the current setting is **Positive** and the measurement increases from right to left, changing the setting to **Negative** will cause the measurement to decrease.

### Radius / Diameter (Measure Setup)

Navigate to



- ① To select **Radius**
- ② To select **Diameter**

The radius/diameter function allows the operator to display actual (radius) or twice-actual (diameter) measurements for each axis. This function is generally used in turning applications, such as the cross travel on a lathe displaying the diameter reading rather than the radius, is the desired result.

# Setting Up The Unit

## Zero Approach Setup

This setting provides a visual indication that one or more axes are approaching zero. This is done by using the far left LED segment on each axis, as the axis approaches zero, each segment of the '0' lights up in quick succession. Once zero has been reached, the '0' to the far left will be constantly on.

Navigate to



Enter any value using the numeric keys to provide zero approach limits. This can be entered in inches or millimeters by toggling the  key.

**Note:** To disable the zero approach function, enter a value of 0.000.

Default is 0.000

## Error Compensation

A digital readout (DRO) system helps to improve productivity. It decreases the number of scrapped parts, as the operator no longer has to be concerned about making mistakes related to counting the revolutions on the dials. The DRO system also helps to eliminate some errors related to ballscrew backlash.

The DRO system will operate to its published accuracy, provided all components are in working order and properly installed. Field calibration is not necessary.

Accuracy problems with machined parts may be caused by machine error, DRO system error, or a combination of both. The first step in determining the source of error is to check the DRO system. This is completed by comparing the movement of the Newall reader head to the position reading shown on the display. A high accuracy standard, such as a laser interferometer is required. A dial indicator can be used to check short distances, but a laser provides the best results. If a dial indicator must be used, be sure it is the highest available accuracy.

### Instructions

#### Check the accuracy of the DRO system

1. Place the target of the laser or the needle of the dial indicator directly on the Newall reader head. It is absolutely critical to take the readings directly from the Newall reader head. If a dial indicator must be used, be sure that the needle of the indicator is perpendicular to the reader head and not angled. If readings are taken anywhere else on the machine, machine errors may distort the results.
2. When the reader head moves, the movement registers on the laser / indicator and the DRO display.
3. Set the laser / dial indicator and DRO position displays to 0.
4. Make a series of movements and compare the position readings between the laser / dial indicator and the DRO display. If the readings match within the accuracy specified, then the DRO system is operating properly. If this is the case, proceed to the next step, "Evaluate machine errors". If the readings do not match, contact your local Newall Service Representative before proceeding with error compensation.

#### Evaluate machine errors

1. Put the laser target / dial indicator on the part of the machine where the machining is performed.
2. Make a series of movements and compare the position readings between the laser / dial indicator and the DRO display. The difference between the laser / dial indicator reading and the reading on the DRO display is the machine error.
3. Plot the machine error along the entire axis of travel to determine the nature of the error. If it is a linear error, you can use linear error compensation. If the error is not linear, you should use segmented error compensation.

# Setting Up The Unit

## Types of Machine Error

There are many types of machine error, including pitch, roll, yaw, flatness, straightness, and Abbé error. The diagrams below demonstrate these errors.

Way errors

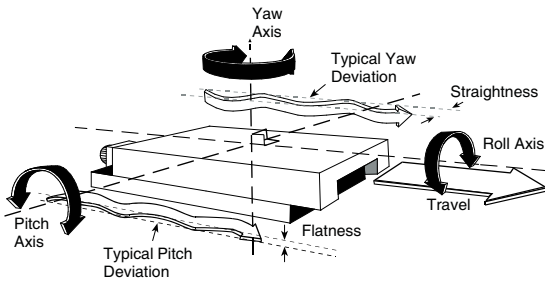

Abbé error

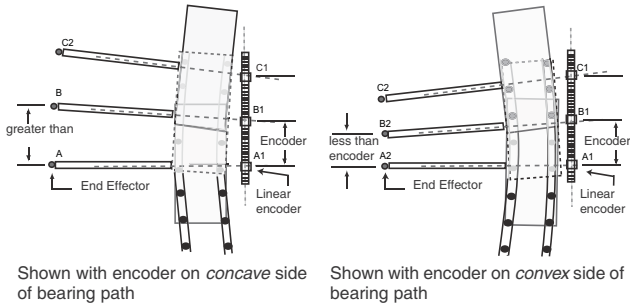

## Linear Error Compensation

In this mode, a single constant correction factor is applied for each axis to all displayed measurements. The correction factor is calculated, and specified in parts per million (ppm).

In this mode a single constant correction factor for each axis is applied to all displayed measurements.

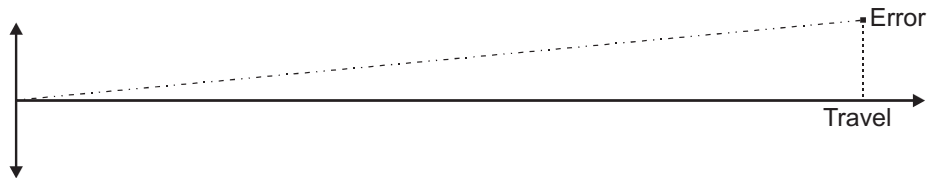

As you follow the procedure ensure that you approach each edge from opposite directions, then subtract the width of the tool from the value displayed on the DP1200. The DP1200 Automatically takes into account the probe diameter as per setting (Linear Only).

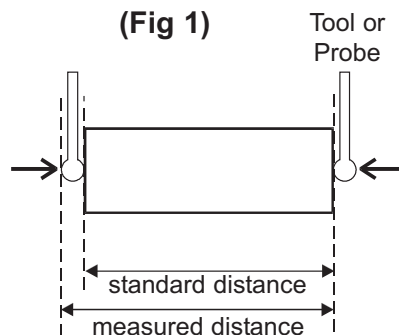

# Setting Up The Unit

## Error Compensation Setup

Navigate to



- ① To select no Compensation (**None**)
- ② To select **Linear Error Compensation**
- ③ To select **Segmented Error Compensation**

## Linear Error Compensation Setup



- ① To select **Teach** mode
- ② To select **Program** mode

## Teach Mode

Teach mode is an easier way of calculating linear errors using the DP1200 to automatically calculate the error, by comparing the actual measurement and the physical movement. Follow the steps below;

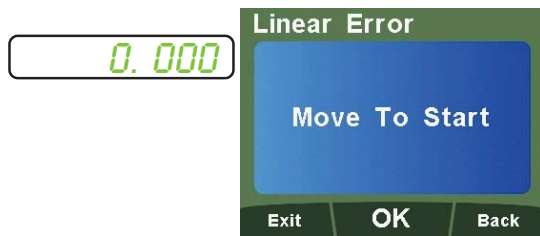

Move tool / probe to start position (See Fig 1)



Move tool / probe to end position (See Fig 1)

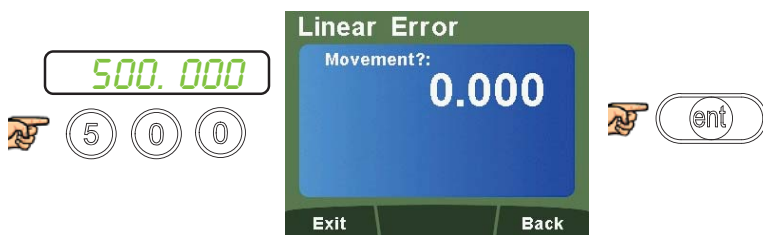

Enter the actual measurement using the numerical keypad



Check / Accept correction factor

## Program Mode

First determine the correction factor required. To do this, use the following equation.  
(In the example the standard distance is 500.000mm and the measured distance is 500.200mm)

$$\begin{aligned} \text{Correction factor} &= \text{error} / \text{actual} \times 1,000,000 \\ \text{Correction factor} &= (500 - 500.200) / 500.000 \times 1,000,000 \\ \text{Correction factor} &= -400 \end{aligned}$$

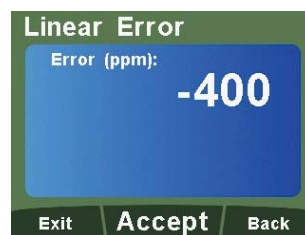

# Setting Up The Unit

## Segmented Error Compensation

The scale travel is broken down into as many as 200 user-defined segments, each with their own correction factor, measured against a high-accuracy standard. The following parameters need to be identified;

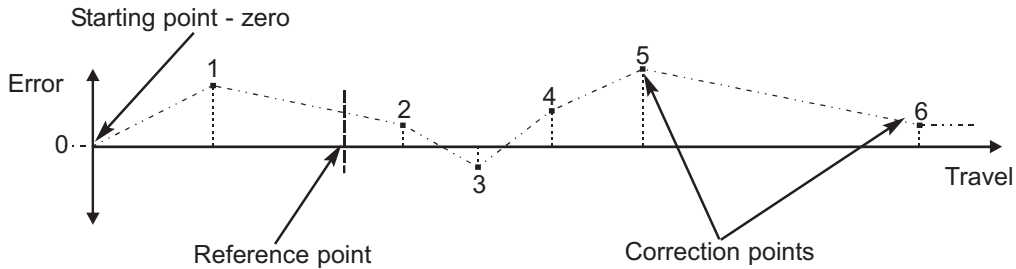

Each Correction Point is measured with respect to the Starting Point - zero - which is usually set close to one end of the scale. The Reference Point can be set anywhere along the scale, and does not need to coincide with either the absolute datum or any of the correction points. However, it may be convenient to make the absolute datum and the reference point the same. Always approach the Starting Point, Correction Points and Reference Point from the same direction. If not, the size of the tool or probe will render the measurement inaccurate.

## Segmented Error Compensation Setup

Setup



① To select **Teach** mode



② To select **Program** mode

## Teach Mode



Enter movement using the numeric keypad



Select "Yes" to move on to point 2 (maximum 200 points). Select "No" to accept the segmented compensation.



# Setting Up The Unit

## Program Mode

The program mode enables the user to define the correction points manually and then enter them into the DP1200. The position is where the correction point occurs, and the correction point is the value to be corrected at that point.



**Position 1:** Enter a value using the numeric keypad for the 1st correction point (I.E 5.000)

**Correction 1:** Enter a value using the numeric keypad for the correction value (I.E -0.010)

**Note:** The correction value is limited to a minimum of 0.005mm (0.0002")



to navigate between points. A maximum of 200 points are available.



OK

to accept the compensation at the point reached.

# Setting Up The Unit

## Setup Axis 4 (Digital Linear)

For models with 5v TTL quadrature 4th axis

### Legend Setup

Please refer to Page 10, Legend Setup

### Encoder Setup

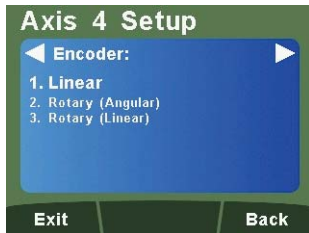

 ① To select **Linear** as the encoder type

### Reference Source Setup

The DP1200 is capable of using an internal reference or an external reference source for the digital 4th axis. An internal reference is the reference mark provided by the encoder.

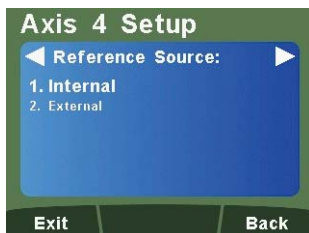

 ① To select **Internal** referencing

 ② To select **External** referencing

### Encoder Resolution

Enter the resolution of the encoder for the 4th digital axis using the numerical keys. It is important the resolution of the encoder is entered exactly or inaccurate measurements will occur.

#### Example:

Linear encoder has a resolution of 0.001mm.

Navigate to



**Note:** Inch / mm function must be set to reflect entered resolution

### Display Resolution

Enter the resolution that is required to be displayed using the numerical keys. The displayed resolution can only be the same or higher than the encoder resolution.

#### Example:

Linear Encoder has a resolution of 1 $\mu$ m (0.001) and is to be displayed at 5 $\mu$ m (0.005).

Navigate to

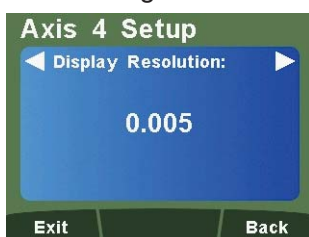

**Note:** Inch / mm function must be set to reflect entered resolution

# Setting Up The Unit

## Direction Setup

Please refer to Page 10, Direction Setup

## Radius / Diameter (Measure Setup)

Please refer to Page 10, Radius / Diameter (Measure Setup)

## Signal Checking Setup

The DP1200 has the facility to detect if the encoder attached to the 4th digital axis has become disconnected, sustained severe cable damage, or with some encoders, experienced electronic failure.

### Mode of Operation

The detection mechanism monitors the incoming signals from the encoder to look for an illegal combination of input levels.



If the encoder becomes disconnected, then the illegal input combination is generated internally within the DP1200. The display will then show 'SIG FAIL'. If it is possible to correct the fault, press the axis zero key to reset that display. If the 'SIG FAIL' message continues to be displayed then the fault has not been corrected.

A	B	RM	Status
L	L	H	SIG FAIL
L	H	X	OK
H	L	X	OK
X	X	L	OK

X = any state i.e can be either high (H) or low (L).

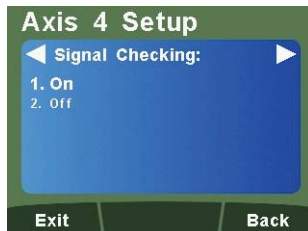
**Note:** Please check the encoder specification for information on the synchronisation of the index marker pulse. If the encoder is capable of generating the illegal condition (A low, B low and RM high), then signal checking function should be **TURNED OFF**.



-  ① To enable Signal Checking
-  ② To disable Signal Checking

## Zero Approach Setup

Please refer to Page 11, Zero Approach Setup

## Error Compensation Setup

Please refer to Page 11, Error Compensation Explanation  
Page 12, Type of Machine Error  
Page 12, Linear Error Compensation Explanation  
Page 13, Linear Compensation Setup

# Setting Up The Unit

## Setup Axis 4 (Digital Rotary Angular)

For models with 5v TTL quadrature 4th axis. The rotary angular option is for customers using a rotary encoder who want an angular displayed measurement

### Legend Setup

Please refer to Page 10, Legend Setup

### Encoder Setup

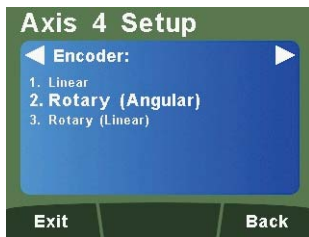

 ② To select **Rotary (Angular)** as the encoder type

### Reference Source Setup

Please refer to Page 16, Reference Source Setup

### Encoder Resolution Setup

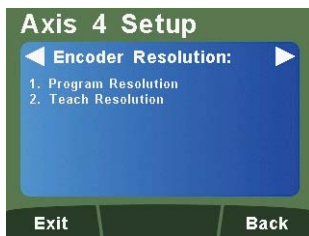

 ① To select **Program Resolution**

 ② To select **Teach Resolution**

### Program Resolution Setup

This setting allows the user to program the DP1200 with a rotary encoder resolution.

Rotary encoder resolutions are usually expressed as **Pulses Per Turn**. This is the number of pulses output per revolution.

Information on the **PPT** can be found in the encoder manufacturer's specification and is also generally marked on the encoder.

Navigate to

#### Example

Rotary encoder has a PPT of 1024



$PPT = \text{Counts per Revolution (CPR)} / 4$

### Teach Resolution Setup



Rotate rotary encoder until a value is displayed in the LCD display.

For this example an 1800 pulse encoder is connected.



# Setting Up The Unit

## Angular Display Setup

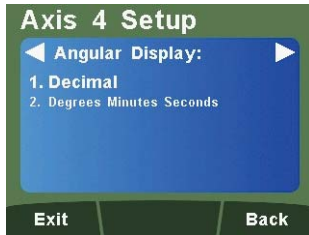

①

To select **Decimal** (Degrees)



②

To select **Degrees Minutes Seconds**

## Angular Mode Setup

This function allows the selection of rollover at 360° back to zero or to provide a continuous measurement.



①

To select **Rollover** (Rollover at 360°)



②

To select **Continuous**

21

## Direction Setup

Please refer to Page 10, Direction Setup

## Signal Checking Setup

Please refer to Page 16, Signal Checking Setup

## Zero Approach Setup

This setting provides a visual indication that one or more axes are approaching zero. It does this by using the far left LED segment on each axis, as the axis approaches zero, each segment of the '0' lights up in quick succession. Once zero has been reached, the '0' to the far left will be constantly on.

Navigate to



Enter any value using the numeric keys to provide zero approach limits. This can be entered in degrees or degrees minutes seconds, dependant on the Angular Display Setting.

**Note:** To disable the zero approach function, enter a value of 0.000.

Default is 0.000

# Setting Up The Unit

## Setup Axis 4 (Digital Rotary Linear)

For models with 5v TTL quadrature 4th axis. The rotary linear option is for customers using a rotary encoder who want linear displayed measurement

### Legend Setup

Please refer to Page 10, Legend Setup

### Encoder Setup



 ③ To select **Rotary (Linear)** as the encoder type

### Reference Source Setup

Please refer to Page 16, Reference Source Setup

### Encoder Resolution Setup

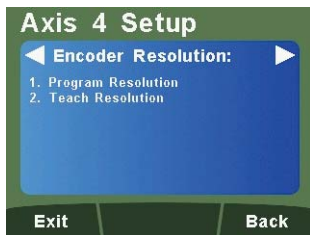

 ① To select **Program Resolution**

 ② To select **Teach Resolution**

### Program Resolution Setup



Enter the linear resolution via the numeric keypad.

**Example:** 10mm linear movement required from 1 revolution of an 1800 pulse rotary encoder

$$\frac{10}{1800} / 4 = 0.0013888$$

### Teach Resolution Setup



Move the rotary encoder to a known start point



Move the rotary encoder to a known end point



Enter the linear movement using the numerical keys



The resolution is calculated by the DRO and displayed



# Setting Up The Unit

## Display Resolution Setup

Please refer to Page 15, Display Resolution Setup

## Direction Setup

Please refer to Page 10, Direction Setup

## Radius / Diameter (Measure Setup)

Please refer to Page 10, Radius / Diameter (Measure Setup)

## Signal Checking Setup

Please refer to Page 16, Signal Checking Setup

## Zero Approach Setup

Please refer to Page 11, Zero Approach Setup

## Error Compensation Setup

Please refer to Page 11, Error Compensation Explanation  
Page 12, Type of Machine Error  
Page 12, Linear Error Compensation Explanation  
Page 13, Linear Compensation Setup

# Setting Up The Unit

## General Setup

### Language Setup





Choose the required language the unit is to display. If the language required is not in the 1st menu press "7" to display more languages.

### Application Setup



 ① To select **Mill**

 ② To select **Lathe**

 ③ To select **Generic**

**Note:** When set to Lathe, Axis 1 (top) changes to diameter measurement

**Note:** When set to Lathe or Mill, some functions are automatically turned off

### Plane Setup

This setting defines the machining face of the work piece, for example; on a turret mill it would typically be the X Axis and the Y Axis. This setting is used by the mill functions.

This setting refers to the legend that has been set for Axes 1, 2 & 3. In the **example** Axis 1 has a legend of 'X', Axis 2 has a legend of 'Y', and Axis 3 has a legend of 'Z'.

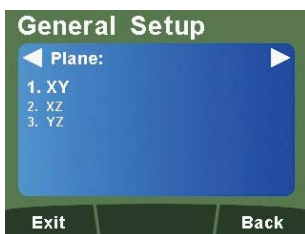

 ① To select **X** and **Y** axes

 ② To select **X** and **Z** axes

 ③ To select **Y** and **Z** axes

### Axis Coupling Setup

This feature enables the permanent summing of Axis 4 with one of the other axes. It is most commonly used for mills. The axes selected in the plane setting parameter will not be summed.

**Example:** The plane has been set to the X and Y Axes, then the fourth axis is summed with Z, (3rd Axis.)



 ① To enable the Axis Coupling feature

 ② To disable the Axis Coupling feature

**Note:** When this feature is active, the 4th Axis display will be blank.



# Setting Up The Unit

## Functions Setup

Allows the user to enable or disable Mill / Lathe functions. Functions in white text are enabled. Functions in grey text are disabled.

**Note:** Some functions may already be disabled if the DP1200 is set as a Mill or Lathe at application setup, and dependant on the number of axes available.

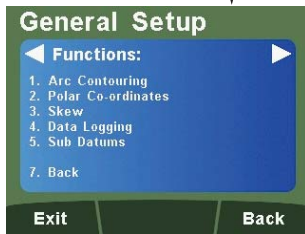

Numeric Key	Function
1	Tool Offsets
2	Vector
3	Taper Angle
4	Axis Summing
5	PCD
6	Line Hole
7	More
<b>Press Key 7 for the options below</b>	
1	Arc Contouring
2	Polar Co-ordinates
3	Skew
4	Data Logging
5	Sub Datums

## Probe Diameter Setup

Allows the user to enter a probe diameter to be used with the DP1200. The probe diameter information can be found in the probe specification.

**Example:** The probe diameter is 5mm.



**Note:** Default value is 4mm

**Note:** Inch/mm key must be set accordingly

## Beep Setup

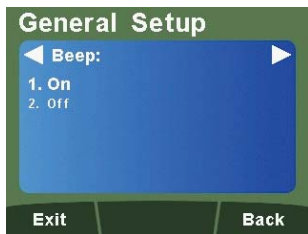

**Note:** Default is Beep On

## LCD Brightness Setup

The DP1200 allows the user to adjust the brightness of the LCD screen for user preference.

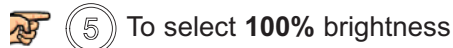
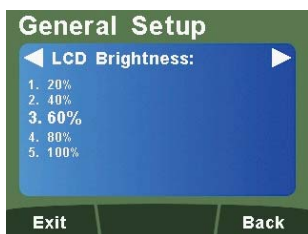

**Note:** Default is 60% brightness

# Setting Up The Unit

## Sleep Setup

Allows the user to select a time period where the unit will automatically go into Sleep Mode. If no movement is made or keys pressed for the time period set, the sleep mode will be activated.

**Example:** The sleep time is required after 5 minutes



**Note:** To deactivate this feature, enter a value of "0" (default)

## Unlock Axis

Allows the unit to be upgraded from a 2 or 3 Axis unit up to 4 Axes. Please contact your local authorised Newall distributor to purchase this option.

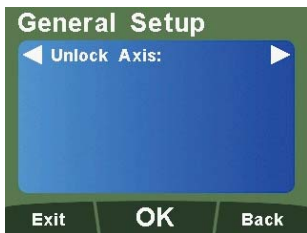

Contact Newall to progress further



## Reset Setup

Allows the user to reset the unit back to factory defaults.

There are three factory default settings according to the application.

**Example:** The unit is being reset as a **Lathe**.



-  ① To default as **Mill**
-  ② To default as **Lathe**
-  ③ To default as **Generic**



**Note:** When the DP1200 is setup as a Lathe, the 'X' (top) Axis default setting is DIA, therefore the 'X' (top) Axis will display double.

**OEM Defaults:** The DP1200 may have OEM default settings specific to a machine. In this case, the DP1200 will only display one reset option. This reset will default all the parameters to match the OEM defaults set for the machine when the DRO was originally installed.

# Standard Functions

This Section details the standard functions of the DP1200.

## Absolute / Incremental

Press  to toggle between absolute and incremental mode

The DP1200 has a dedicated key to switch the positional displays between absolute (abs) and incremental (inc) measurements. The current display mode is indicated by a red LED either above or below the key as shown on the right.

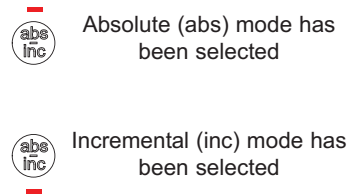

### Using Incremental Mode

In Incremental Mode the DRO displays the position relative to the last position. This is also known as point-to-point use. In this mode you can set the value for each axis or zero it to create an Incremental Datum. This does not effect the machine's Absolute Datum that you configure in Absolute Mode.

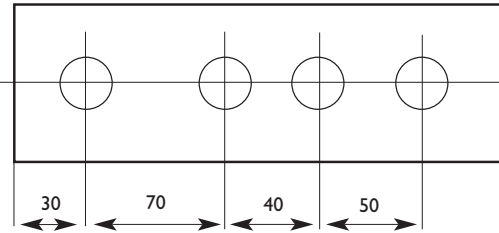

### Using Absolute Mode

In Absolute Mode the DRO displays the positions of all the axes with respect to a fixed datum. The datum is set by entering an axis position when in Absolute Mode.

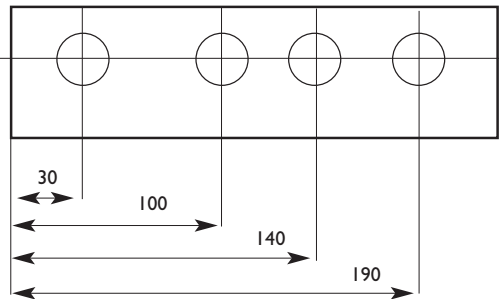

### Example of Absolute and Incremental use

Set absolute zero at lower left corner of the part



Move to first position in ABS (Hole A)



Move to second position in ABS (Hole B)



Switch to incremental mode and zero the display

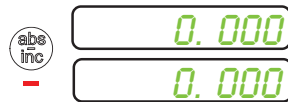

Make an incremental move to Hole C



Switch to absolute mode

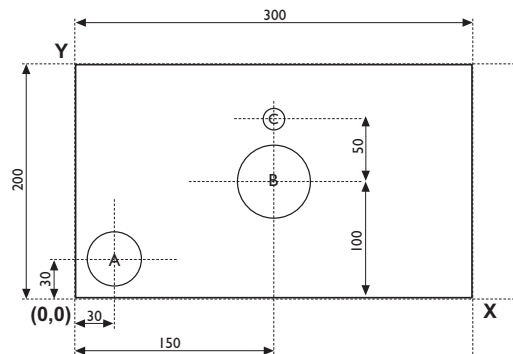

## Inch and mm

Press  to toggle between Inch and mm mode

The DP1200 has a dedicated key to switch the positional displays between imperial (inch) and metric (mm) measurements. The current display mode is indicated by a red LED either above or below the key as shown on the right.

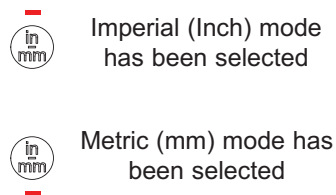

# Standard Functions

## Zero and Preset an Axis

Press  to toggle between 'Set' and 'Zero' Mode

The DP1200 has a dedicated key to switch the operation of the axis selection key between Zero Mode and Set Mode. The selected mode is indicated by an LED either above or below the key as shown on the right.

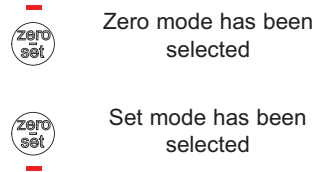

### Using Set Mode

With Set Mode selected, this enables the select axis keys to prompt a numeric entry into the desired axis. Once the correct value has been selected, it can be set into the axis by pressing . This can be seen in the example on the right.



 Press the axis select key relevant to the axis

 Input the required numeric value

### Zeroing an Axis in Set Mode

With Set Mode selected, it is possible to zero the axis conveniently by double pressing the relevant select axis key. This can make use of the DP1200 Zeroing and Set Modes quicker and easier. This is shown in the example on the right.

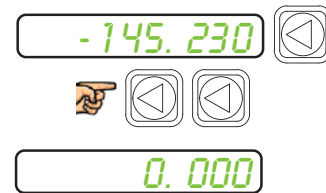

### Using Zero Mode

With Zero Mode selected, this enables the select axis keys to zero each axis independently. This can be seen in the example on the right.

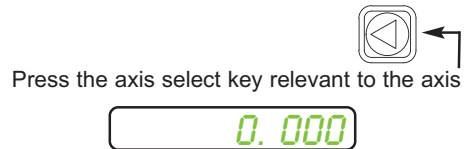



## Undo Function

The DP1200 stores the last 10 positions/numeric inputs, which can be accessed using the undo  feature.



### Example 1 - non movement



Display shows  input a value 

An incorrect figure has been entered and you want to get back to the dimension displayed before

Press , display now shows 

### Example 2 - movement

Input a value  move to that point, display now shows 

Input a value  move to that point, display now shows 

Press  once, display now shows  this is the position of your second point

Press  again, display now shows  this is the position of your starting point

# Standard Functions

## Half Function / Centre Find

Press  $\frac{1}{2}$  key to initiate the half function.

The DP1200 has a dedicated key to halve the value of any axis. This is done by initiating the half mode and selecting the required axis. This can be seen in the example on the right.

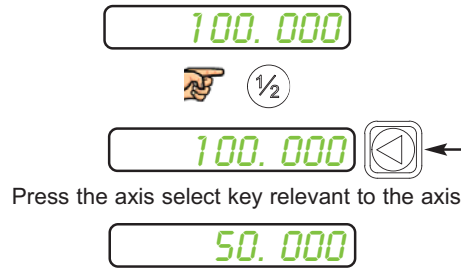

## Digifind / Reference Function

The DP1200 comes equipped with Digifind, a feature unique to Newall Digital Readouts. Digifind eliminates the risk of losing your position and datum setup. Digifinds precise setup of a workpiece is carried out only one time. When the unit is powered on, it displays the position at power off, compensated for any movement of a Spherosyn Encoder up to 0.2500" (6mm) and a Microsyn Encoder up to 0.1000" (2.5mm) in either direction since the unit was last used. If the machine has moved beyond 0.2500" (6mm) for Spherosyn or 0.1000" (2.5mm) for Microsyn, Digifind allows a quick means to find the datum if lost. Follow the steps below;

Make a mark on both a stationary part and moving part of the machine. The marks must be aligned and will serve as the machine "home" position. (The mark must be indelible and must allow the operator to move the machine to within a 0.2500" (6 mm) for Spherosyn or 0.1000" (2.5mm) for Microsyn around the mark at any time.) Alternatively, you can use a convenient reference point on the workpiece.

### Setting the reference

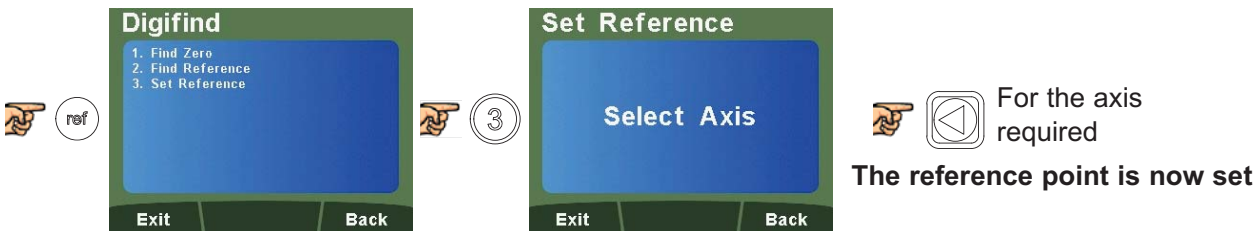

### Finding the reference

If datum is lost at anytime, it is possible to "Find" the datum again. Position the machine within a 6mm (0.2500") band for Spherosyn or a 2.5mm (0.1000") band for Microsyn.

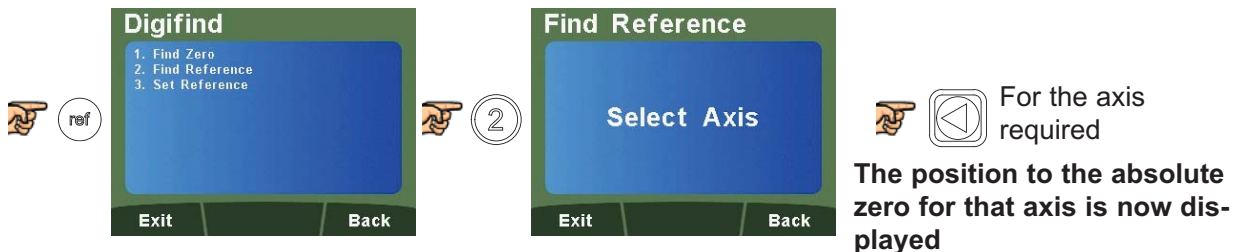

### Finding zero

As a fail safe, Digifind can "Find" the last datum or absolute zero set. Position the machine within a 6mm (0.2500") band for Spherosyn or a 2.5mm (0.1000") band for Microsyn.

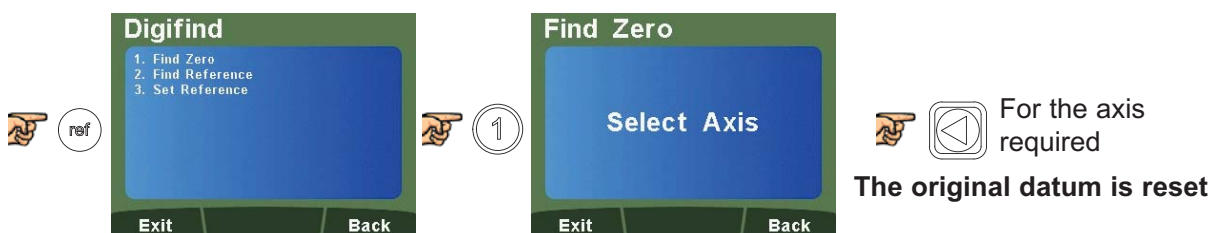

# Standard Functions

## Sub Datums / Memory

The DP1200 can store up to 200 SDM (Sub-Datum) positions, or machining steps, into the memory. Using SDM allows the operator to work to zero by calling up stored dimensions, instead of "working up" to drawing dimensions. This eliminates the need to constantly refer to the drawing and reduces the possibility of scrapping parts due to misread dimensions. It also speeds up positioning as the operator is working to zero.

The SDM's are stored as co-ordinates relative to the absolute datum position. If the absolute datum position changes, the SDMs will "shift" to the new datum.

Once a repetitive sequence of co-ordinates is entered into SDM, the co-ordinates can be recalled at any time. The positions remain in memory until altered by the operator. Simply assign any SDM number 1 - 200 to each machining step. When machining, call up each step (SDM) number and work to zero. Sub Datums can be used for any or all axes. There are two ways to store Sub Datums; Teach Mode and Program Mode.

See examples below.

### How to navigate to the Sub Datum Function

**Menu**

1. Tool Offsets
2. Vector
3. PCD
4. Line Hole
5. Arc Contouring
6. Skew
7. Sub Datums
8. Data Logging
9. Setup

**Sub Datums**

1. Use Datums
2. Teach Datums
3. Program Datums

- ① Use SDM's
- ② Teach SDM's
- ③ Program SDM's

### How to use Sub Datum Teach Mode

Select **Teach Datums** to reach the screen below

**Teach Datums**

Datum: <001>

**Acquire** Move machine to the first sub datum location Repeat until all sub datums have been entered

**Back** to return to the Sub Datums Menu or **Exit** to return to normal operation

### How to use Sub Datum Program Mode

Select **Program Datums** to reach the screen below

**Program Datums**

Datum: <001>

Enter sub datum value for this axis Repeat for each axis

to move to next sub datum

**Back** to return to the Sub Datums Menu or **Exit** to return to normal operation

# Standard Functions



## Sub Datums / Memory (Continued)



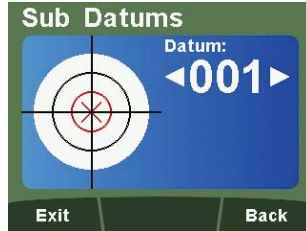

### How to use Sub Datums

Select **Use Datums** to reach the screen below



The DRO will display the distance needed to move to the sub datum point. The sub datum point destination is 0 for each respective axis.

   to scroll through sub datums or use the numeric keypad to input the sub datum required

  to return to the Sub Datums Menu or   to return to normal operation



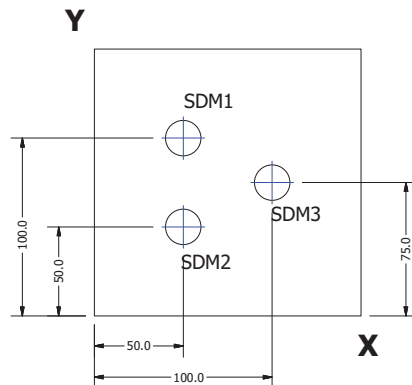

### Example of Sub Datums



## Sleep Mode

The DP1200 offers two different ways to put the DRO into sleep mode; using the sleep key or automatically after a set period of time (See Page 24 - Sleep Setup).

### Entering Sleep Mode using the sleep key

  to turn all displays off apart from the Power LED. Any key presses or movement will **not** bring it out of this mode. To return to normal operation  , the unit will boot up to the start screen. Once any key is pressed, the DP1200 will return to normal operation.

### Entering Sleep Mode automatically

Once setup, (See Page 24 - Sleep Setup), apply no movement or any key presses for the period of time set and the DP1200 will turn off all displays apart from the power LED. Any key presses or movement **will** bring it out of this mode.

# Standard Functions

## RS232 (Data Logging) / Data Acquisition

The DP1200 can offer basic serial communication via a dedicated RS232 compatible port, which is used for data logging purposes.

## RS232 Connections

The RS232 is connected to the DP1200 via a 15-pin D-type connector at the rear of the display. The required connection details are shown below.

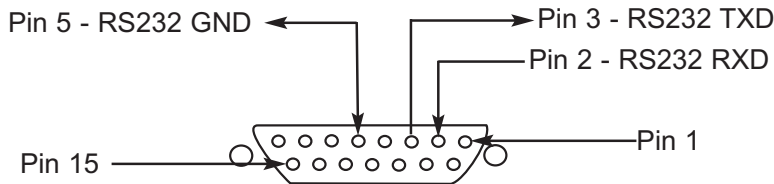

The RS232 port allows position data from the DRO to be sent to a computer.

Applications:

- Quality Control – Save dimensional data from finished parts
- Test and measurement
- Length gauges

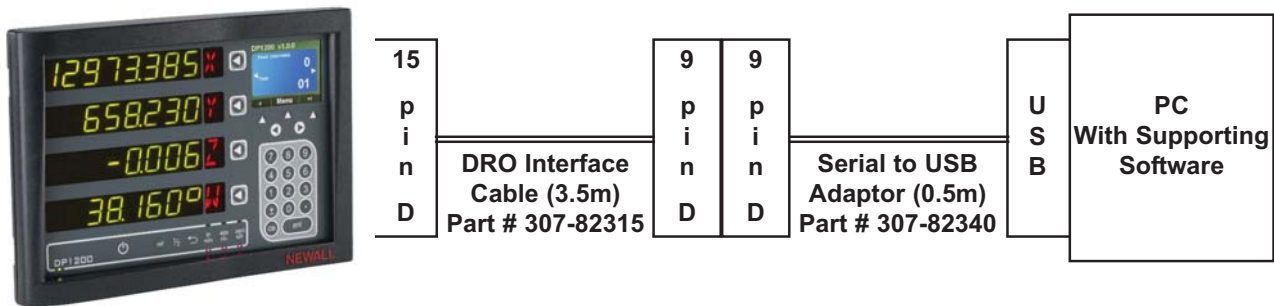

## RS232 Setup

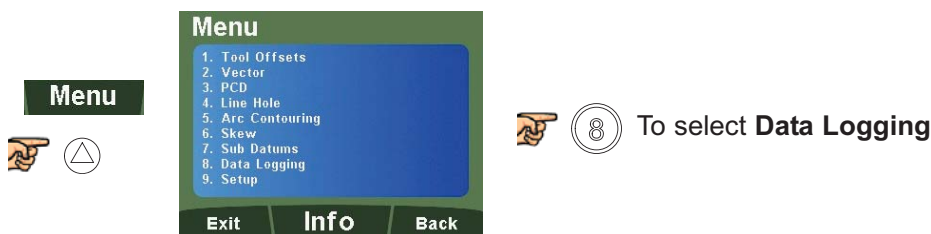





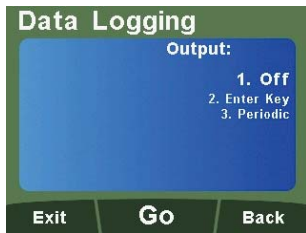

# Standard Functions

## RS232 Setup (Continued)



-  ① To turn Data Logging off
-  ② To use Enter Key to trigger Data Logging
-  ③ To select Data Logging periodically

**Go**



If **off** is selected   to return to the main menu and disable Data Logging

If **Enter Key** or **Periodic** are selected  



Select the Baud Rate to match the baud rate supported at the PC



-  ① To select **None** (disable Parity)
-  ② To select **Even** Parity
-  ③ To selects **Odd** Parity



**Note:** Period will only be shown if the **Periodic** output was selected

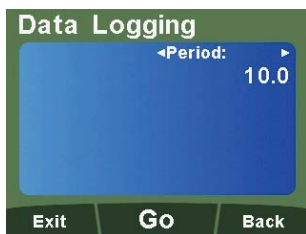

Enter, using the numeric keypad, the number of seconds between each communication



**Go**



**Exit**



The RS232 is now live and functioning

# Standard Functions

## RS232 Output Data Format

The output data from the RS232 is as follows;

The current axis data for the axes available on the system is transmitted.

For two axes systems, only two axes of data will be transmitted.

The data packet structure of 12 characters is defined as follows:

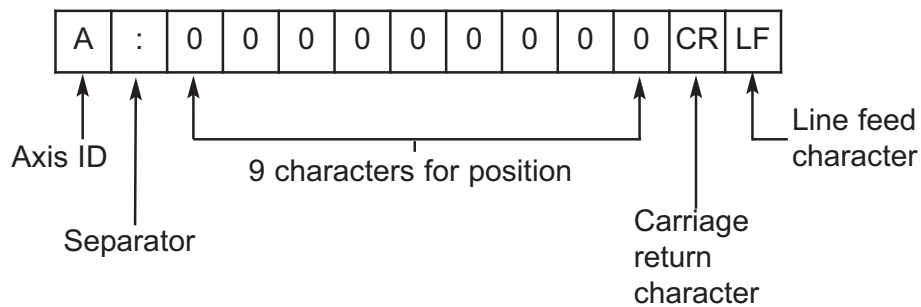

The **Axis ID** is the representation of the axis at the time of printing. This will be shown by the legend set for the axis at that time. Please see example below;

### Example:

The example below shows an RS232 output from a 4 axes DP1200, with the legend set as "X" (1st axis) "Y" (2nd axis), "Z" (3rd axis) and "W" (4th axis).

X: 531.420

Y: 497.615

Z: 15.006

W: 131.295

# Mill Functions

## PCD / Bolt Hole Circle

The DP1200 calculates positions for a series of equally spaced holes around the circumference of a circle. Once the parameter data is entered, the DP1200 displays the distance to the next hole. The operator works to zero for each hole location. See example (Fig 1).

**Note:** This function only operates in the axes that have been setup in the plane (See Page 24 - Plane Setup).

**Menu**

1. Tool Offsets
2. Vector
3. PCD
4. Line Hole
5. Arc Contouring
6. Skew
7. Sub Datums
8. Data Logging
9. Setup

Exit Info Back

③ To select **PCD** (Bolt Hole Circle)

### Example

Enter 1st centre coordinate      ① ② ⑤ ① ② ⑤      ent

Enter 2nd centre coordinate      ⑨ ⑨ ① ⑦      ent

▶

PCD Setup

<Centre: ▶  
125.250  
99.700

Exit Go Back

Enter the diameter dimension      ① ⑤ ①

ent

PCD Setup

<Diameter: ▶  
150.000

Exit Go Back

Enter the number of holes required      ⑤

ent

PCD Setup

<Holes: ▶  
5

Exit Go Back

Enter start angle required      ① ⑧      ent

**Note:** The PCD will be calculated from the 3 o'clock position, counter-clock wise. Enter the angle as a negative value if it is given as clockwise from 3 o'clock.

PCD Setup

<Start Angle: ▶  
18.000

Exit Go Back

Enter end angle required      ① ⑧      ent

**Note:** End angle must equal start angle for a full circle PCD routine.

PCD Setup

<End Angle: ▶  
18.000

Exit Go Back

# Mill Functions

## PCD / Bolt Hole Circle (Continued)

**Note:** At this point you can use the ◀ ▶ keys to navigate back and forth through the menus.

To start the PCD / Bolt Hole Circle Routine;

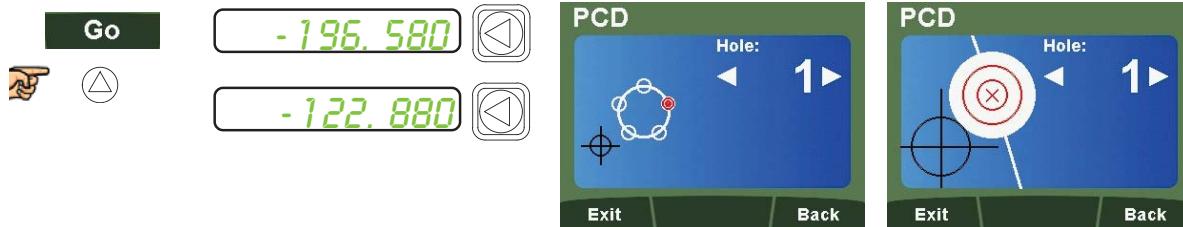

Navigate through the sequence of holes by using ◀ ▶ keys.

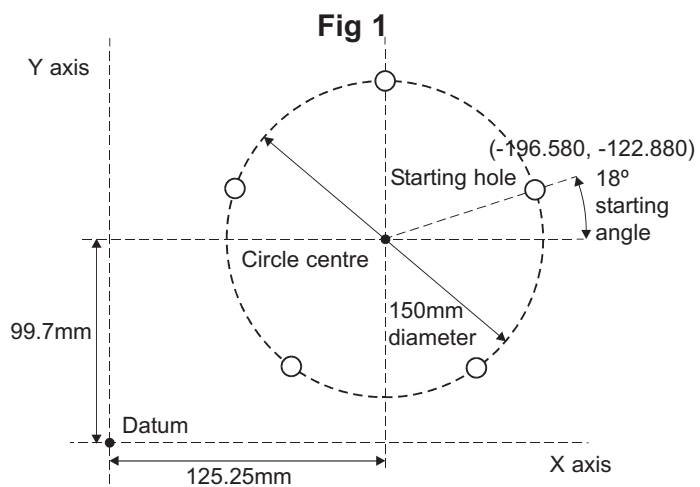

# Mill Functions

## Line Hole

The DP1200 calculates positions for a series of equally spaced holes on a line. Once the parameter data is entered, the DP1200 displays the distance to the next hole. The operator works to zero for each hole location. See example (Fig 2).

**Note:** This function only operates in the axes that have been setup in the plane (See Page 24 - Plane Setup).



## Example

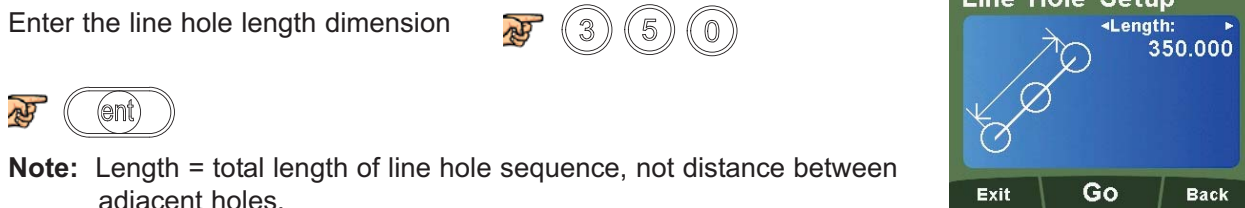
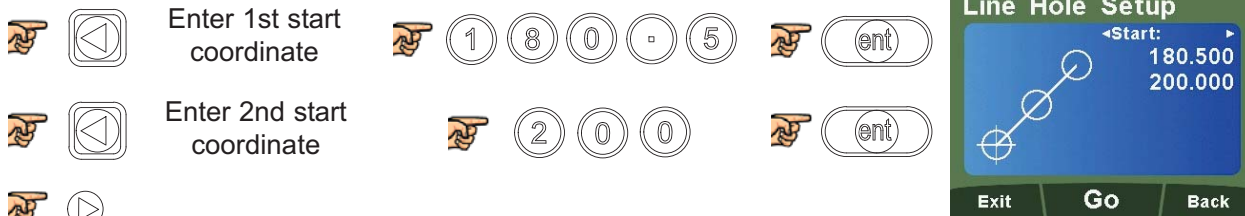

**Note:** At this point you can use the ◀ ▶ keys to navigate back and forth through the menus.

# Mill Functions

## Line Hole (Continued)

To start the line hole circle routine;

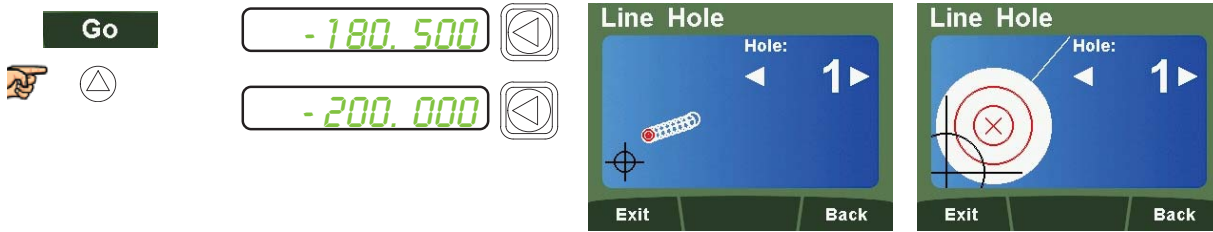

Navigate through the sequence of holes by using ◀ ▶ keys.

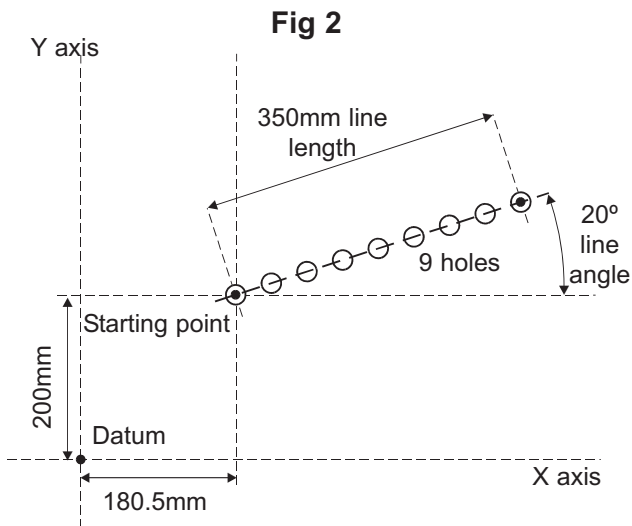

# Mill Functions

## Arc Contouring

The DP1200 calculates positions for rough machining of an arc or radius. The message display prompts the user for parameters needed to complete the calculations.

Once parameters are entered, the DP1200 shows the co-ordinates, which are point to point positions along the arc. The operator works to zero for each hole location. See example below.

The arc feature is dependant on the **Plane** setting for the axes it will operate in (See Page 24 - Plane Setup).

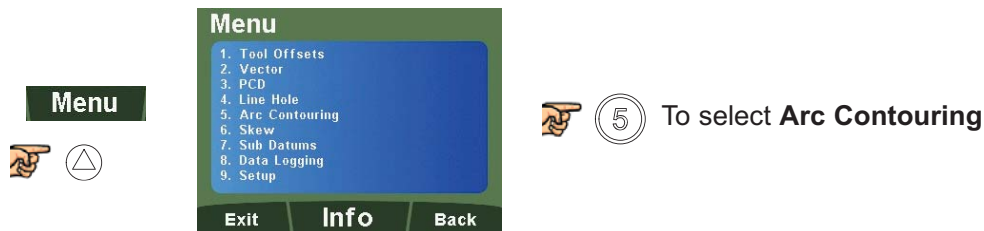

**Note:** Use the ◀ ▶ keys to navigate through the parameters.



Enter coordinates for the center of the arc.

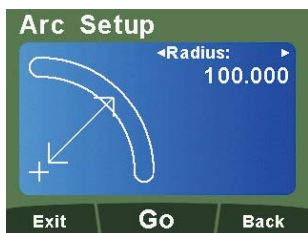
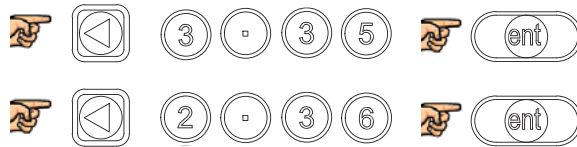

Enter the radius dimension.



Enter coordinates for starting point of arc.

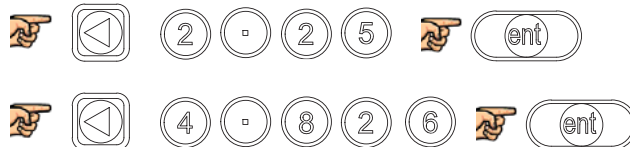

# Mill Functions

## Arc Contouring (Continued)



Enter coordinates for ending point of arc.

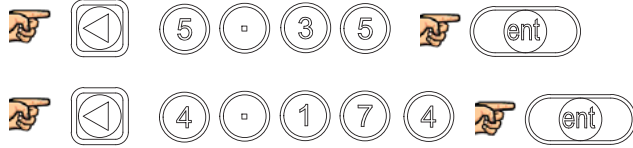

Enter the tool diameter to be used.

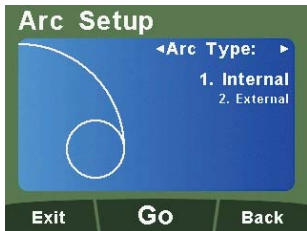

Select the appropriate arc type. For this example, we will select internal.



Enter the maximum cut required.



**Go**

To start the arc feature;



Navigate through the sequence of points using the  $\leftarrow$   $\rightarrow$  keys.

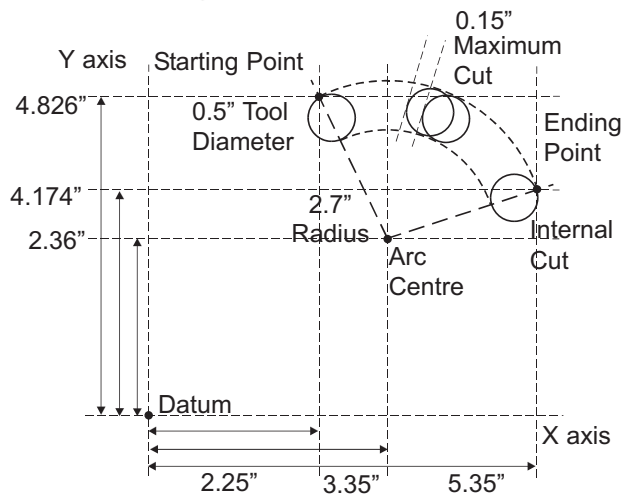



# Mill Functions



## Polar Co-ordinates

The Polar Coordinate function enables the operator to convert the displayed data from the conventional Cartesian Coordinates ("X" & "Y") to polar coordinates (radius length + angle).

The two axes used for polar coordinates are defined in the parameter setting for plane (See Page 24 - Plane Setup). The fourth axis cannot be used for polar coordinates.

The example below demonstrates its operation.



   until the display shows



Move from the starting point to the ending point.

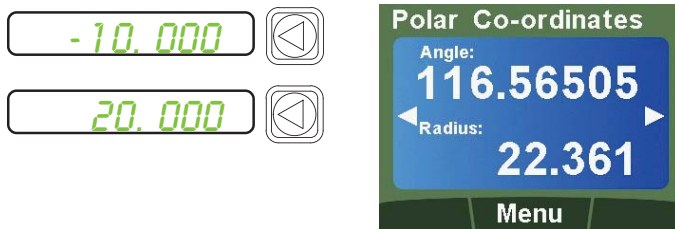

The message display will show the angle and the radius length.

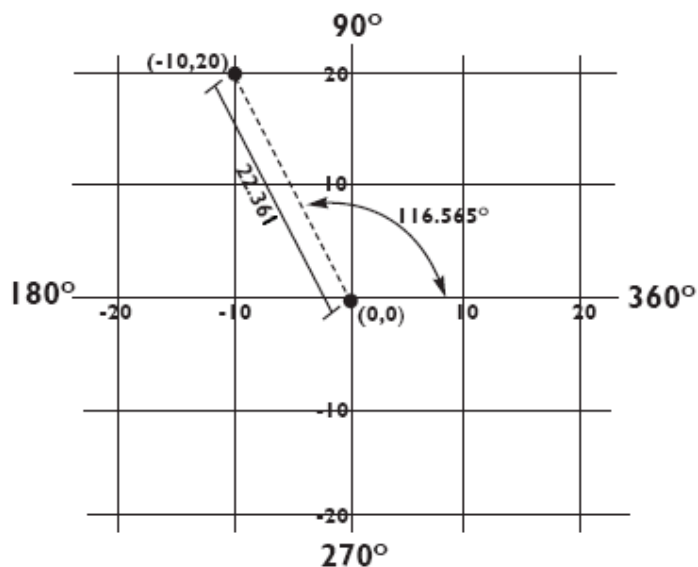

# Mill Functions

## Skew

The Skew Feature provides capability for the DRO to find the skew angle of a part. It is very useful for the machine operator to know if the part is square to the bed.

It can also be used to find other angles on the workpiece.

The plane setting parameter defines which axes are used for this feature.

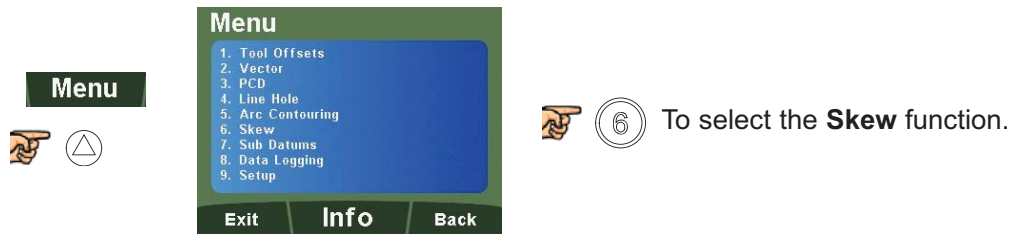

**Note:** Use the ◀ ▶ keys to navigate through the parameters.

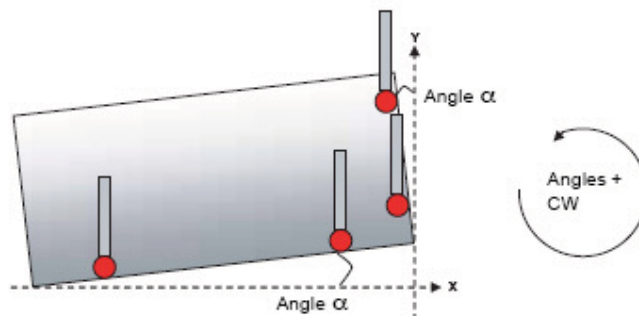

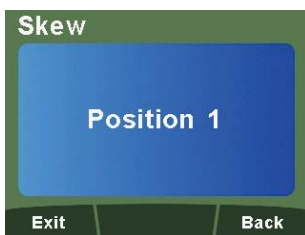

Note that positions 1 and 2 are points on the first plane (Angle 1). Positions 3 and 4 are points along the second plane (Angle 2).



Touch the probe to any position along the ("X") first plane.

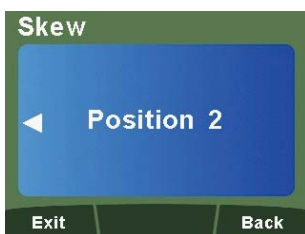

Or

Touch the tool to any position along the first plane  



Touch the probe to a second point along the ("X") first plane.

Or

Touch the tool to a second point along the first plane  

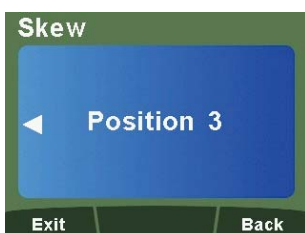

Touch the probe to any position along the ("Y") second plane.

Or

Touch the tool to any position along the second plane  

# Mill Functions

## Skew (Continued)

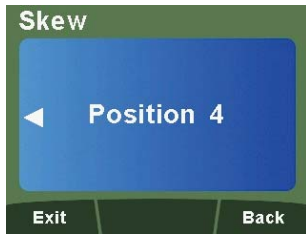

Touch the probe to a second point along the ("Y") second plane.  
Or

Touch the tool to a second point along the second plane  



The angle for ("X") plane 1 and ("Y") plane 2 are shown on the DRO.

# Lathe Functions

## Tool Offsets

The Tool Offset function allows the operator to enter and store offsets for a range of tools. This enables the operator to change tools without resetting absolute zero or datum. Using Tool Offsets ensures that diameter and length measurements will remain consistent after tool changes. This speeds up tool changes and increases productivity as it eliminates the need for the operator to stop and manually measure the diameter.

The number of Tool Offsets available is 50. This large number allows tools to be grouped where more than one set is used. For convenience, it is highly recommended that tools are physically marked with their corresponding tool number.

There are two ways to set Tool Offsets, Teach Mode and Program Mode.

The DP1200 provides capability for Tool Offsets for up to 3-axes. A 3 or 4 axes DP1200 is required to use 3-axes of Tool Offsets.

DP1200 Tool Offsets are all in reference to the datum.



 ① To select **Tool Offsets**



 ① To select **Teach Offsets**

 ② To select **Program Offsets**

## Teach Offsets

Enter the tool dimensions one axis at a time. In this example, the “X” axis of Tool 1 is entered.



 of the required axis

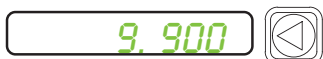

Take a skim cut if “X” is selected. Take a face cut if “Z” is selected.

The axis window shows the size of the tool with respect to the datum.



**Note:** The tool can now be moved away from the part

# Lathe Functions

## Teach Offsets (Continued)

9.850 



Measure the part using an accurate gauge and enter this value.

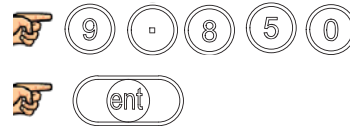

Repeat this process for all tools required.

**Note:** Use the   keys to navigate through the tools

## Program Offsets



Enter the tool dimensions one axis at a time.

102.225 

50.000 

25.755 







  of the required axis

Enter the position value using the numeric keys



Repeat this process for all tools required.

Once complete:   

**Note:** Use the   keys to navigate through the tools.

# Lathe Functions

## Vector

Vectoring combines the movement of the “X” and “Z” axes with the angle of the compound.

**Note:** Vector is only available on 3 and 4 axes units.

If the compound is set at an angle, vector is very useful. If the compound is aligned with the “X” or “Z” axis, the summing function should be used.



② To select **Vector**

Enter the desired vector angle.



**Example**

③ ① (ent) To start: Go

**Note:** Changing of the angle is always done through the Vector Setup Screen. The angle cannot be changed while the vector function is running.



Axis 1 shows combined “X” axis movement

Axis 2 shows combined “Z” axis movement

Axis 3 shows normal position display

To exit:

Done

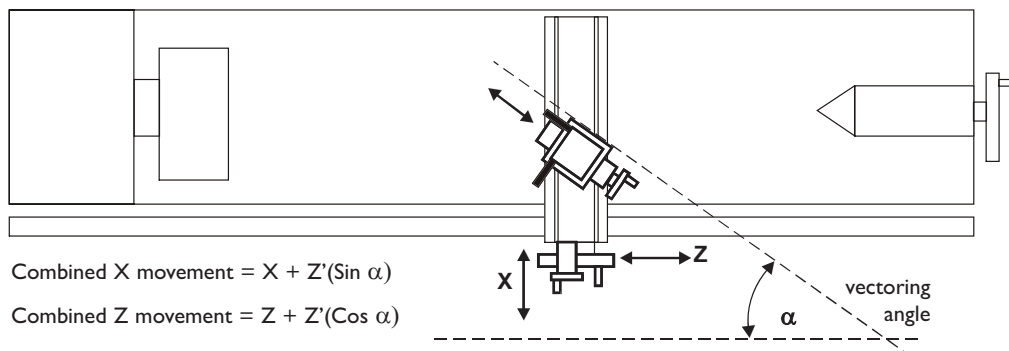

# Lathe Functions

## Taper Angle

The Taper Function shows the angular displacement of the displayed position. Axis 1 and 2 are used for this function. The taper function ignores the parameter setting for the plane.

The example below demonstrates its operation.



until the display shows



Touch the tool to one end of the taper and zero both axes, then touch the tool at the other end of the taper. The message window will now display the taper angle, as shown below;

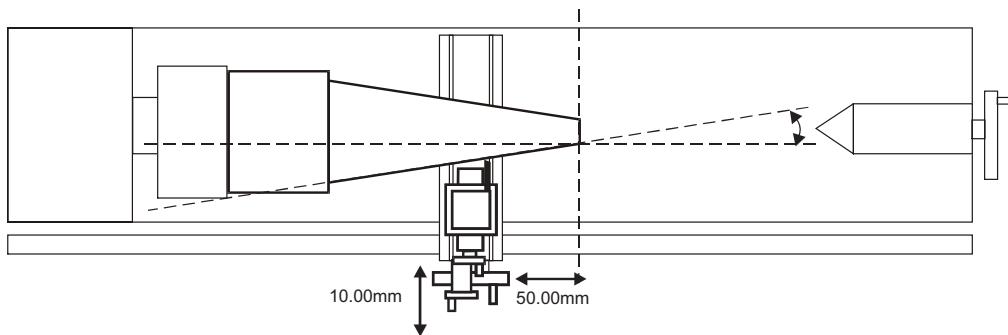
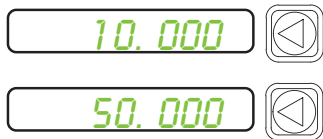

# Lathe Functions

## Axis Summing

The Summing Function allows the sum of the two selected axes to be displayed. Axis 4 is not used with this function. See Axis Coupling Setup (Page 24) for details on using Axis 4.



until the display shows



Select the required plane

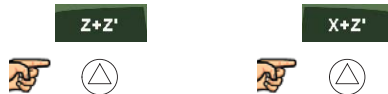

The un-summed position data will be shown in the axis window.  
The summed position will be shown in the LCD display.

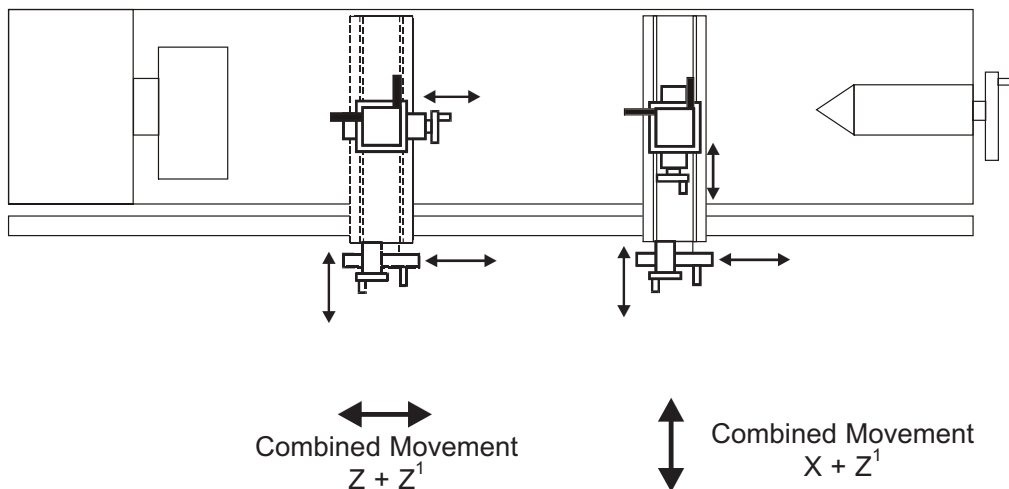
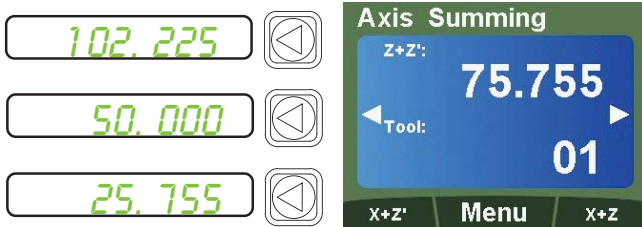



# Troubleshooting Guide

The DP1200 has a dedicated information screen which provides useful information when contacting Newall or troubleshooting the unit. This is especially useful when a panel mount unit is in use.



To return to menu

Symptom	Solution
The display is blank	<ul style="list-style-type: none"> <li>The DP1200 maybe in sleep mode. Press any key to exit sleep mode</li> <li>Check that the power supply is correctly connected to a working mains outlet</li> <li>Check that the power supply cables are not damaged</li> <li>Check that the power supply voltage is 15 - 24Vdc <math>\pm</math>10%</li> <li>Check the power supply indicator is illuminated on the front of the DP1200.</li> </ul>
The display works, but resets from time to time without any keys being pressed.	<p>Either the supply voltage is too low, or the power supply or mains supply has an intermittent fault.</p> <ul style="list-style-type: none"> <li>Check that the power supply voltage is 15 - 24Vdc <math>\pm</math>10%.</li> <li>Check that all the connections are secure.</li> </ul>
The display works, but gives erratic readings, the last digit jitters or the measurements jump to new figures unexpectedly.	<p>There may be a poor earth (ground) connection. Both the DP1200, and the machine on which it is installed, must have proper earth (ground) connections.</p> <p>There may be a problem with the encoder.</p>
The unit does not respond to any key presses.	Disconnect the DP1200 from its power supply, wait 15 seconds and then reconnect.
'no Sig' or 'SIG FAIL' appears in the display.	<p>This indicates that the unit is not receiving a proper signal from the encoder.</p> <ul style="list-style-type: none"> <li>Check that the encoder connections are secure.</li> <li>Check that there is no damage to the connectors or to the encoder.</li> <li>Switch the DP1200 off and back on again.</li> <li>Swap the encoder to another axis to confirm whether the encoder or the DP1200 is at fault.</li> </ul>
Readings are incorrect.	<ul style="list-style-type: none"> <li>Check the Encoder Type to ensure it is correct.</li> <li>Check the Radius / Diameter setting. The Diameter setting causes the axis to read double.</li> <li>Check the Error Compensation factors.</li> <li>If using the Segmented Error Compensation, verify the datum position.</li> <li>Swap the encoder to another axis to confirm whether the encoder or the DP1200 is at fault.</li> <li>Check that there is no damage to the encoder or its cable.</li> <li>Check that the encoder is fixed firmly and aligned correctly, as described in the Spherosyn / Microsyn Installation manual.</li> <li>Check that there is no binding on the scale. With the scale brackets slightly loosened, you should be able to slide the scale back and forth with minimal resistance.</li> <li>If you have a Spherosyn scale, check that the scale is not bent, by removing it and rolling it on a flat surface.</li> </ul>

**If the solutions suggested above do not solve your problem, contact Newall's Technical Support Department for further instruction.**

### Swapping encoders to trace a fault:

1. Check that the two axes are set to the correct encoder types.
2. Disconnect the DP1200 power supply.
3. Disconnect the encoder from the malfunctioning axis and move to a working axis.
4. Reconnect the DP1200 power supply and turn on.

**If the fault stays with the same encoder, then the encoder is at fault. If the fault does not follow with the encoder the DP1200 is at fault.**

Providing you have not moved the machine more than 6.3mm (0.25") for a Spherosyn Encoder or 2.5mm (0.1") for a Microsyn Encoder, switching the power off and back on again does not lose the datum position.

**Newall Measurement Systems Ltd.**

Technology Gateway, Cornwall Road  
South Wigston, Leicester LE18 4XH United Kingdom  
Tel: +44 (0) 116 264 2730 • Fax: +44 (0) 116 264 2731  
E-mail: [sales@newall.co.uk](mailto:sales@newall.co.uk) • Web: [www.newall.co.uk](http://www.newall.co.uk)

**Newall Electronics Inc.**

1778 Dividend Drive  
Columbus, Ohio 43228 USA  
Tel: +1 614 771 0213 • Fax: +1 614 771 0219  
E-mail: [sales@newall.com](mailto:sales@newall.com) • Web: [www.newall.com](http://www.newall.com)

**Beijing Newall Technology Co., Ltd**

Rm. 2112 Ruicheng International  
No. 71 Chaoyang Road, Chaoyang District  
Beijing, 100123 China  
Tel: +86 10 858 44 817 • Fax: +86 10 858 44 827  
E-mail: [sales@newall.cn](mailto:sales@newall.cn) • Web: [www.newall.cn](http://www.newall.cn)

**SALES & SERVICE:**

**A Tech Authority, Inc.**

13745 Stockton Ave.  
Chino CA 91710  
909-614-4522  
[sales@atechauthority.com](mailto:sales@atechauthority.com)

**NEWALL**



023-81510-UK/0