

LM13 linear magnetic encoder system

EMC compliance



The LM13 encoder system conforms to the relevant harmonised European standards for electromagnetic compatibility as detailed below.

BS EN 61326

Patents

Features of RLS's encoder systems and similar products are the subjects of the following patents and patent applications:

GB 0720972.9	EP 0514081
EP 0388453	US 5,241,173
US 5,063,685	JP 3,202,316
JP 2837483	

Further information

For further information relating to the installation of LM13 encoder system, see also the LM13 data sheet or LM13 DPI data sheet (part no. LM13D02 or LM13D04). These can be downloaded from our website www.rls.si and are also available from your local representative.

Disclaimer

Considerable effort has been made to ensure that the contents of this document are free from inaccuracies and omissions. However, RLS merilna tehnika d.o.o. makes no warranties with respect to the contents of this document and specifically disclaims any implied warranties. RLS merilna tehnika d.o.o. reserves the right to make changes to this document and to the product described herein without obligation to notify any person of such changes.

Storage and handling

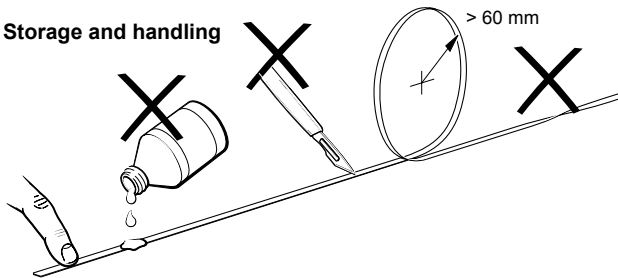

WARNING: The MS magnetic scale should not be exposed to magnetic flux densities higher than 50 mT on its surface. Magnetic fields higher than 50 mT can damage the scale.

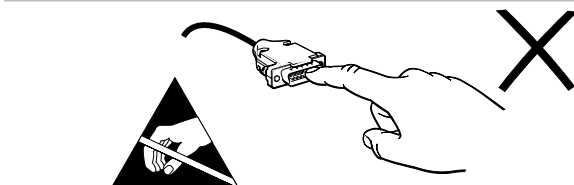
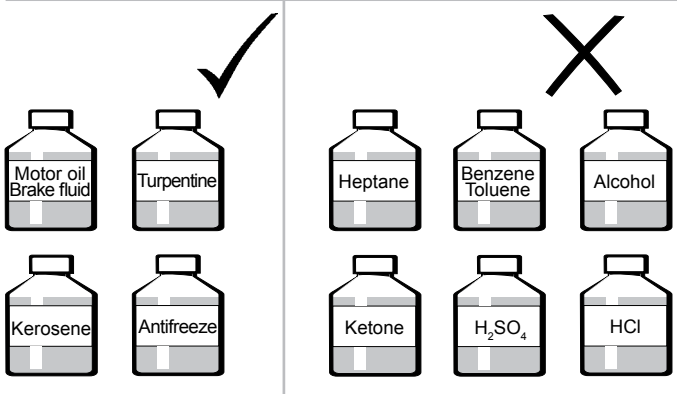

Storage and handling continued

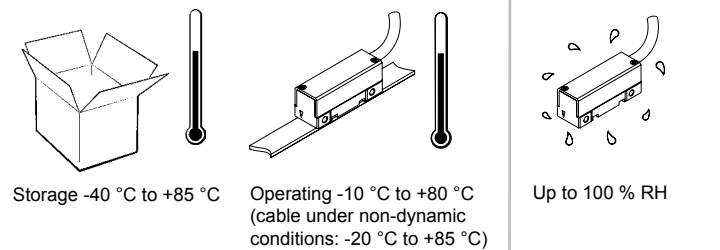
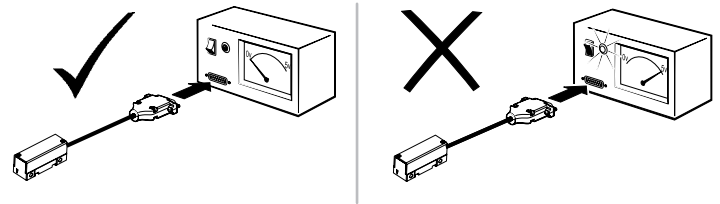

System description

The LM13 encoder system consists of an LM13 readhead on MS magnetic scale offering a range of industry standard digital and analogue output options.

Reference mark

The repeatable bi-directional reference signal can be provided in 3 ways.

- Stick-on reference mark.** The LM13 readhead should be ordered with the reference mark option. After installation of the scale a reference mark sticker can be applied to the scale at the required position using the reference mark applicator tool. Ensure that the reference sticker is oriented to the corresponding side of the readhead that has the reference mark detector installed.
- Selected at point of order.** The LM13 readhead should be ordered with the reference mark option. If required, the cover foil can be installed over the cut reference mark.
- Every 2 mm.** The LM13 readhead should be ordered with this specific mode activated only.

LED indicator

The LM13 set-up LED provides visual feedback of signal strength, error condition, for set-up and diagnostic use.

Green indicates good signal strength/set-up

Red indicates poor signal strength - adjustment required

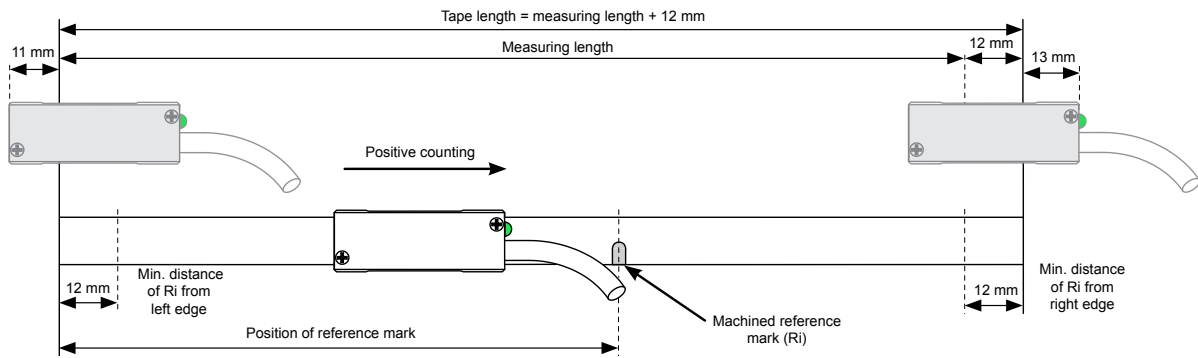

Scale installation

The LM13ASC00 scale guide is mounted in place of any RLS LM13 readhead and uses motion of the axis to apply MS magnet scale parallel to the guideway - a one man, one hit operation.

1. Prepare scale and surface

- Ensure scale is cut to correct length and mounting surface has been cleaned and degreased.

2. Load the scale into the scale guide

- Separate the backing paper from the first 40 mm of scale and feed it into the scale guide as shown.
- Push the scale carefully through to the end of scale mark, ensuring that it does not stick to the mounting surface until it is in position

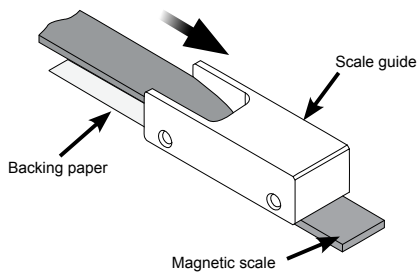

NOTE: To prevent the scale sticking to the mounting surface during this operation it may be necessary to re-apply approximately 20 mm of backing paper to the end of the scale before inserting through scale guide.

- Attach the end of the scale to the mounting surface with light finger pressure.

3. Apply the scale

- Traverse the axis through its full travel at a slow, steady speed.
- While moving the axis:
 - Apply a light finger pressure to the scale behind the scale guide to attach it to the mounting surface.
 - Gently pull the backing paper away from in front of the scale guide as it is separated.

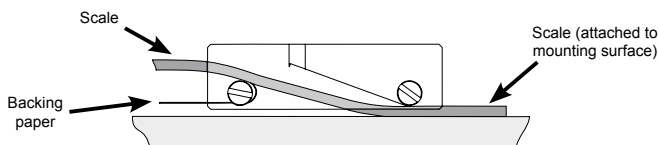

4. Remove the scale guide

- When the axis has reached the limit of its travel, lock the axis in place and unbolt the scale guide from the readhead mounting bracket.

5. Ensure complete adhesion

- Apply firm finger pressure along the full length of the scale from the centre outwards to each end.

6. Apply cover foil (if used)

- Degrease the tape surface with alcohol.
- Install as per scale installation instructions in step 2 onwards.

Readhead installation

Once installed the readhead can be easily adjusted on the machine using the set-up LED indicator.

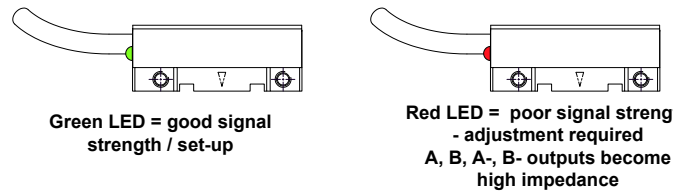

Readheads can be ordered preset to the required resolution or provided so that they can be programmed as needed on the machine to the chosen resolution. This programming is carried out by connecting the readhead to a computer via a programming interface.

Stick-on reference mark installation

1. Install scale (+ optional cover strip) – place the reference mark applicator tool on scale in the correct orientation/required position along the length.

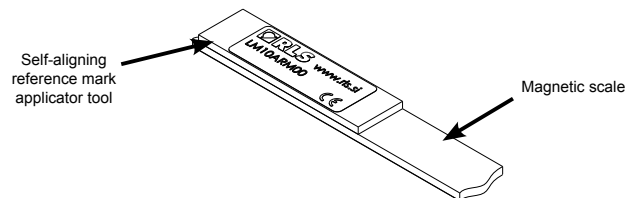

2. Remove the backing tape from the reference mark sticker and carefully attach it to the surface of the scale by placing it against the end of the applicator tool.

NOTE: The correct orientation of reference mark is crucial. The mark on the sticker should be on the same side as the reference mark designators.

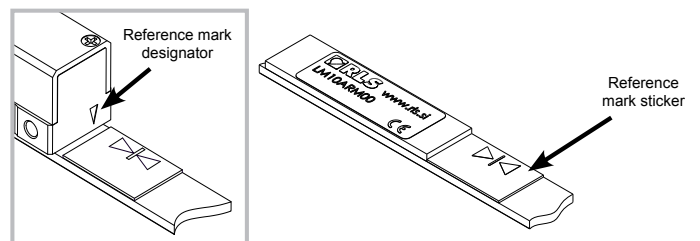

3. Remove the applicator tool leaving the reference mark sticker in the desired position.

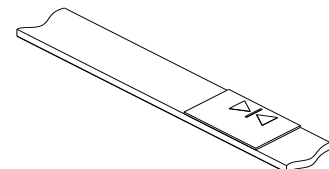

LM13 system dimensions

Dimensions and tolerances in mm.

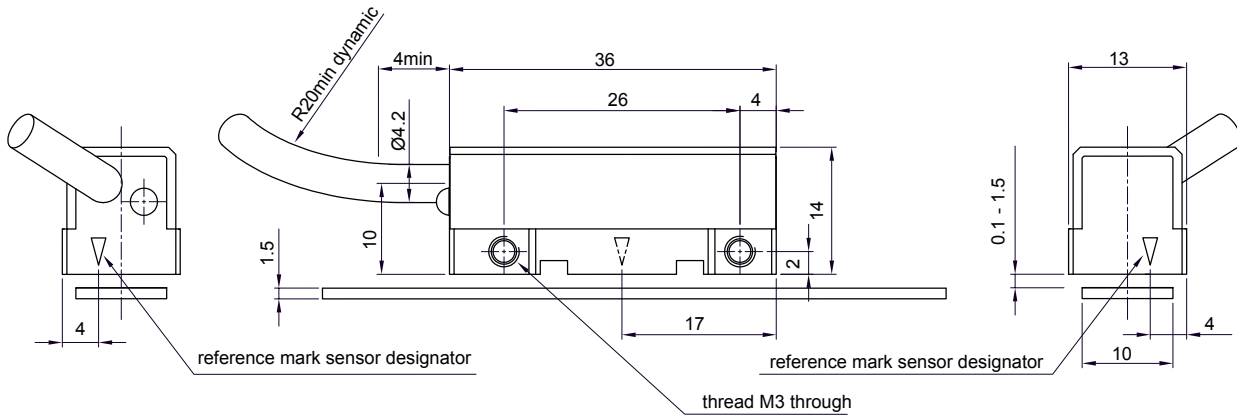

NOTE: Ensure recommended M3 readhead fixing screws are tightened to 0.5 Nm to 0.7 Nm.

Readhead installation tolerances

Ride height

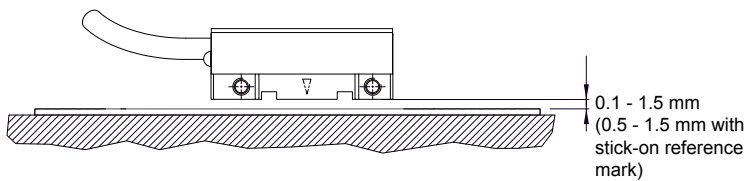

Pitch

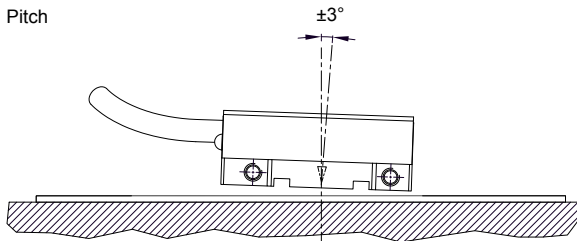

Yaw

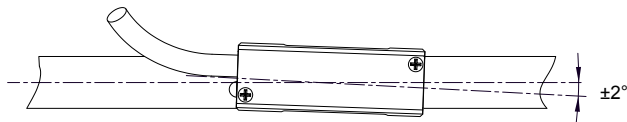

Roll

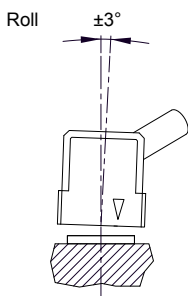

Lateral offset

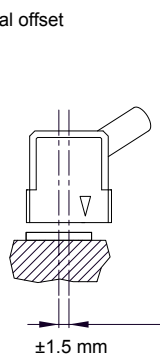

General specifications

Power supply	4.6 V to 7 V – reverse polarity protected; voltage on readhead *
Power consumption	< 30 mA – without load
Voltage drop over cable	13 mV/m – without load 54 mV/m – with 120 Ω load
Environmental sealing	IP68 (according to IEC 60529)
Temperature	Operating -10 °C to +80 °C (cable under non-dynamic conditions: -20 °C to +85 °C) Storage -40 °C to +85 °C
Shock	300 m/s ² , 11 ms (IEC 60068-2-27)
Vibration	300 m/s ² , 55 Hz to 2000 Hz (IEC 60068-2-6)
Cable	PUR high flexible cable, drag-chain compatible, double-shielded 8 × 0.05 mm ² ; durability: 20 million cycles at 20 mm bend radius

* On readhead with 1 m cable; for longer cables please consider voltage drop on cable (13 mV/m without load, 54 mV/m with 120 Ω load per channel pair).

Electrical connections

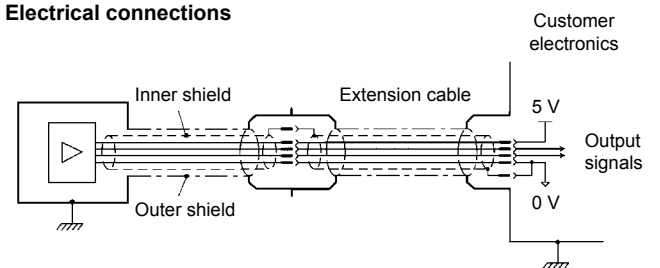

Connections for digital outputs

Function	Signal	Colour	15 pin D type male (option D)	9 pin D type male (option A)
Power	5 V	Brown	7	5
	0 V	White	2	9
Incremental signals	A+	Green	14	4
	A-	Yellow	6	8
	B+	Blue	13	3
	B-	Red	5	7
Reference mark	Z+	Pink	12	2
	Z-	Grey	4	6
Shield	Inner	Green/ Yellow	15	1, 9
	Outer	-	Case	Case

Timing diagram

Complementary signals not shown

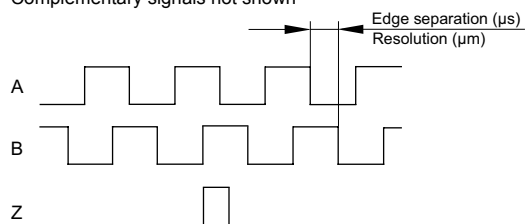

Recommended signal termination

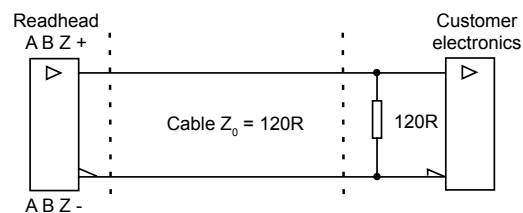

SALES & SERVICE:

A Tech Authority, Inc.
13745 Stockton Ave.
Chino CA 91710
909-614-4522
sales@atechauthority.com