







Contents

<u>Specification</u>		Page 3	Feed Rate Functions	Page 34
Electrical		Page 3	Tool Offsets	Page 34/35/36
Physical		Page 3	Logging Function	Page 37
Environment		Page 3	Logging Connection	Page 37
Accreditation		Page 3	Using the Logging Function	Page 37
Disposal		Page 3		
Input and Resolution		Page 3	<u>Mill Function</u>	Page 38
			Arc Contouring	Page 38
<u>Mounting Options</u>		Page 4	Pocket /Island Milling	Page 39
Stand Alone		Page 4	PCD / Bolt Hole Circle	Page 40
Panel Mount		Page 4	Grid	Page 41
			<u>Lathe Function</u>	Page 41
<u>Connection Details</u>		Page 5	Vector	Page 42
Important Information		Page 5	Taper Turning	Page 42
Connections		Page 5		
			<u>Trouble Shooting</u>	Page 43
<u>Display and Keypad</u>		Page 6		
Understanding the Display		Page 6		
Understanding the Keypad		Page 6		
<u>Setting up the Unit (Linear)</u>		Page 7		
Navigation Setup		Page 7		
DRO Setup		Page 8/9		
Encoder Setup		Page 10/11		
Reset Settings		Page 11		
Language Setup		Page 12		
Brightness Setup		Page 12		
Sleep Timer Setup		Page 13		
Axis Legend Setup		Page 13		
DRO Type Setup		Page 14		
Scale Factor Setup		Page 14		
Beep Enable setup		Page 15		
Feed Rate Setup		Page 15		
Function Setup		Page 15		
Digital Type Setup		Page 16		
Rotary Mode Setup		Page 16		
Digital Res Setup		Page 16		
Digital Res Setup teach		Page 17		
Signal Check Setup		Page 17		
Quad Index Setup		Page 18		
Display Resolution Setup		Page 18		
Gear Ratio		Page 18		
Zero Approach Setup		Page 19		
Plane Setup		Page 20		
Zero Threshold		Page 20		
Summing Setup		Page 20		
Encoder Direction Setup		Page 21		
Measurement Mode Setup		Page 21		
Error Compensation		Page 21/22		
Type of Machine Error		Page 22		
Linear Error Compensation		Page 23		
Segmented Error Compensation		Page 23/24/25/26		
Notes		Page 27		
<u>Standard Functions</u>		Page 28		
Absolute / Incremental		Page 29		
Zero and Pre Set an Axis		Page 30		
Inch/ mm Modes		Page 30		
Setting Function Keys		Page 31		
Quick Setting Function Keys		Page 31		
Using Function Keys		Page 31		
DigiFind/ Reference Function		Page 32		
Sub Datums / Memory		Page 33/34		

Specification

Electrical

EU Directive 73/23/EEC (Low Voltage Directive)
BS EN 55022:1998 Class B
BS EN 55024:1998

Input to Power Supply Unit (Supplied)
100-240V (47-63Hz)
External switch-mode - Output voltage 15VDC
Input Voltage to NMS800 12-27VDC $\pm 10\%$
Conforms to Low Voltage Directive

Physical

Height 188mm (7.4")	Depth 48mm (1.89")
Width 306mm (12.072")	Weight 0.5kg (1.1lb)

Environment

Climatic Range	Storage Temperature	-20°C to 60°C
	Working Temperature	0°C to 55°C
	Working Humidity	80% R.H. at 30°C

IP-Ingress Protection IP40 Stand Alone, IP54 Panel Mount

Accreditation

CE UKCA

Disposal

At the end of its life, please dispose of the NMS800 Digital in a safe manner applicable to electrical goods

Do not burn

The casework is suitable for recycling. Please consult local regulations on disposal of electrical equipment

Input and Resolution

Either the Newall 'serial' or 'digital' encoders support a TTL output can be used with the NMS800 DRO depending on which model.

Resolutions

Dependant on Encoder (Linear)

0.1 μ m (0.00001")
0.5 μ m (0.00002")
1 μ m (0.00005")
2 μ m (0.0001")
5 μ m (0.0002")
10 μ m (0.0005")

Dependant on Encoder (Rotary)

Program PPR, 0 - 90,000,000

Newall Measurement Systems Limited reserves the right to make changes to this specification without notice

Mounting options

Standalone Mount Options



Panel Mount Option

PLEASE NOTE: The Minimum Cut-out Size for the connection is 122.00mm x 84.00mm

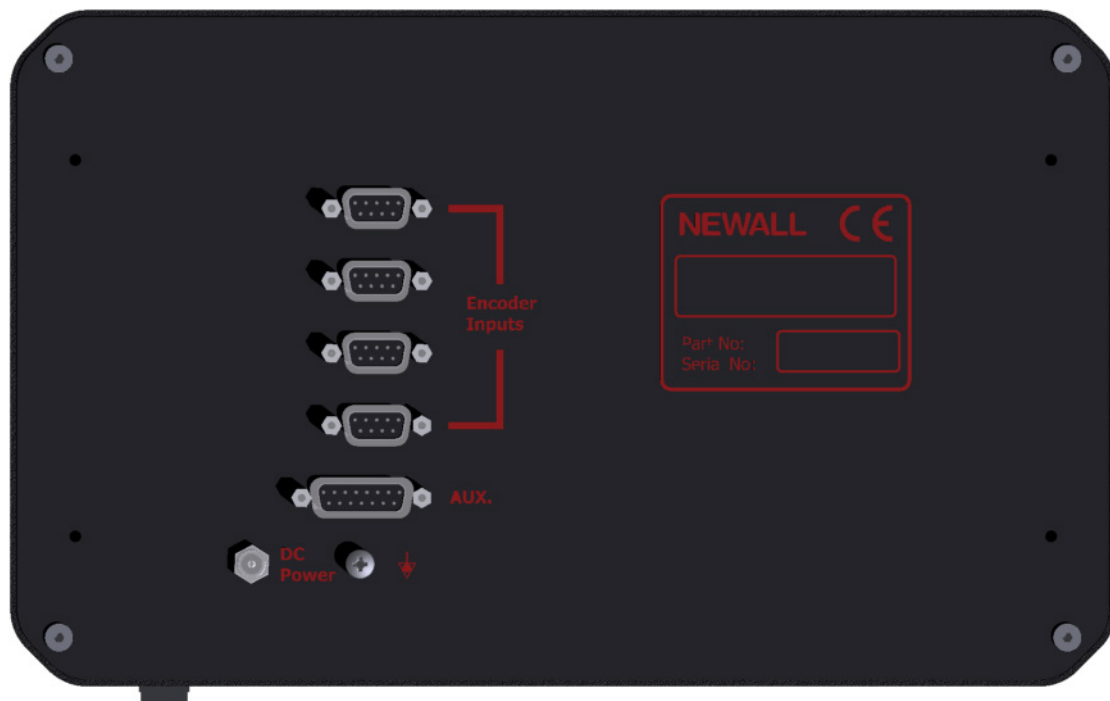

Connection details

Important Details

The serial NMS800 is compatible with Newall Spherosyn Serial and Microsyn Serial encoders, along with other encoders. Digital version will work with any TTL encoders

It is important to ensure that:

- ✓ Secure all the cables to prevent the connectors from dropping into hazardous positions (for example the floor or coolant tray) when they are unplugged.
- ✓ Route all cables to prevent them from being caught on moving parts.
- ✓ The NMS800 is grounded to the machine, using the braided grounding lead provided, before the machine supply is turned on.
- ✓ The power has been disconnected, before the encoder(s) are connected.

Do not connect this unit directly to the mains supply.

Connections

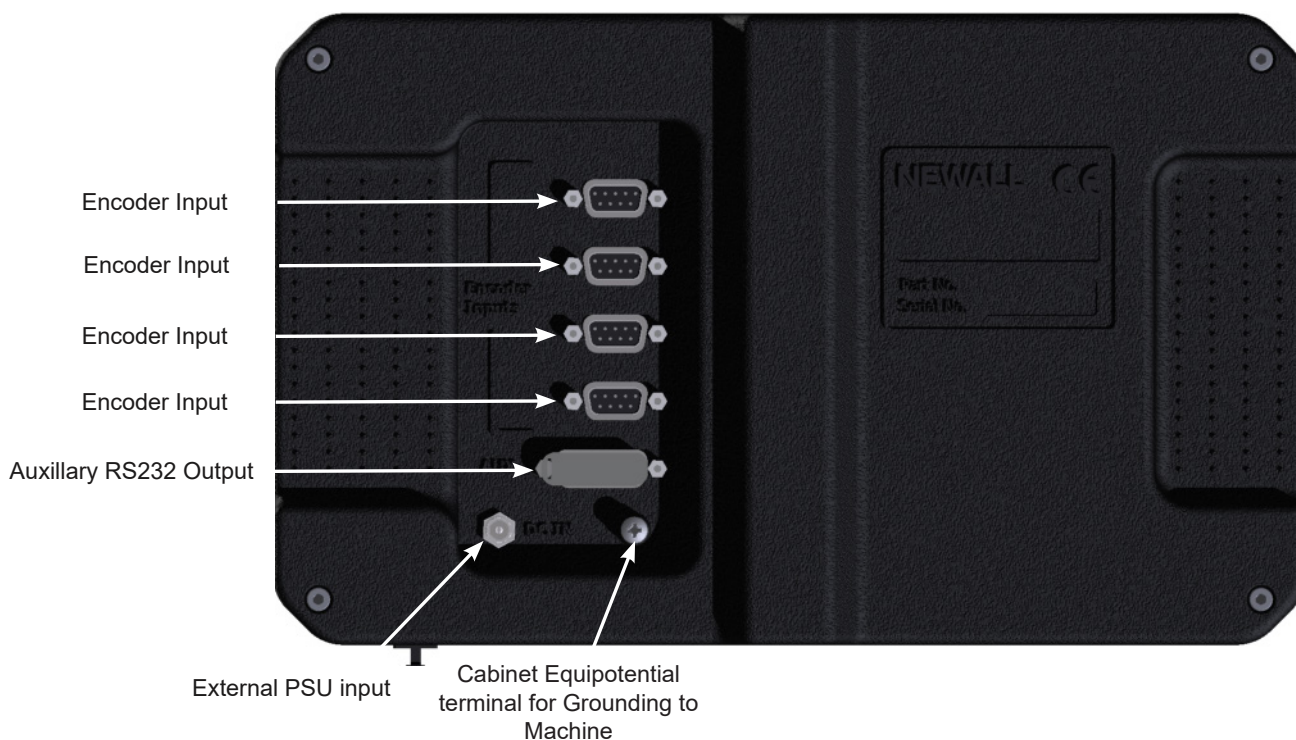

Display and keypad

Understanding The Display

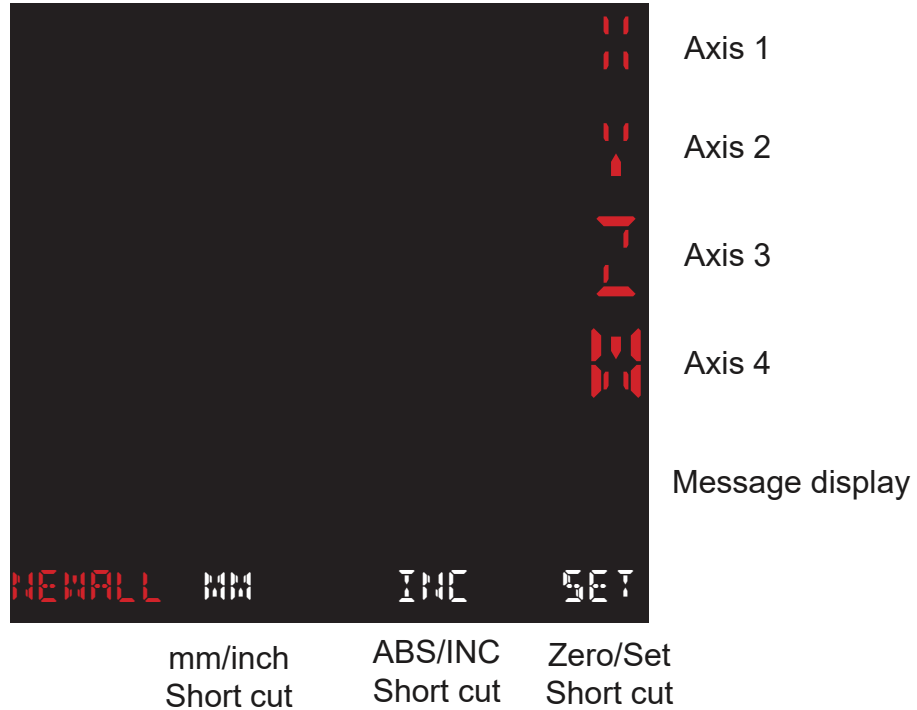

Understanding The Keypad

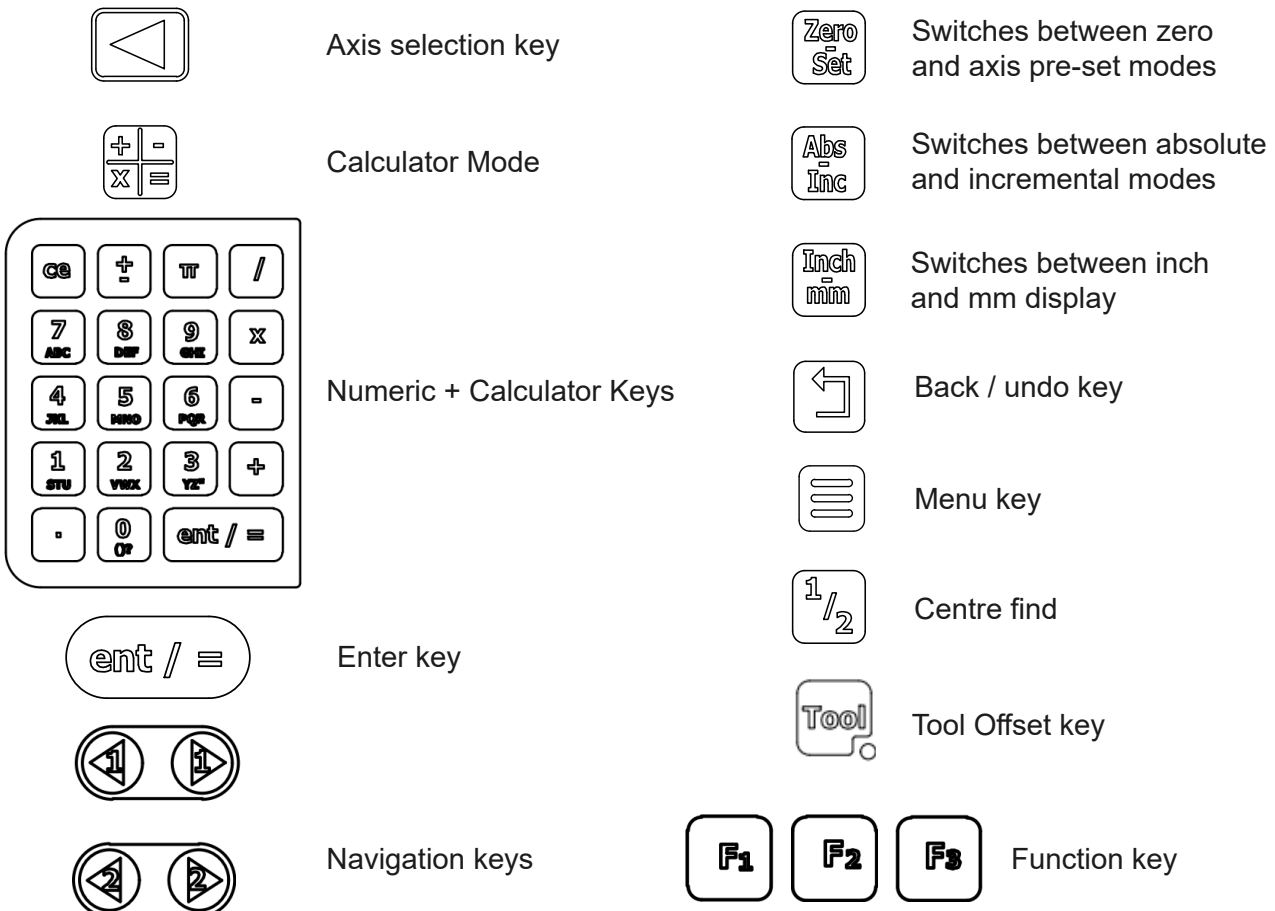

Setting up the unit

Navigating Setup

How to enter setup



PLEASE NOTE: To apply any changes, you must exit back through to the menu.

Display Setup

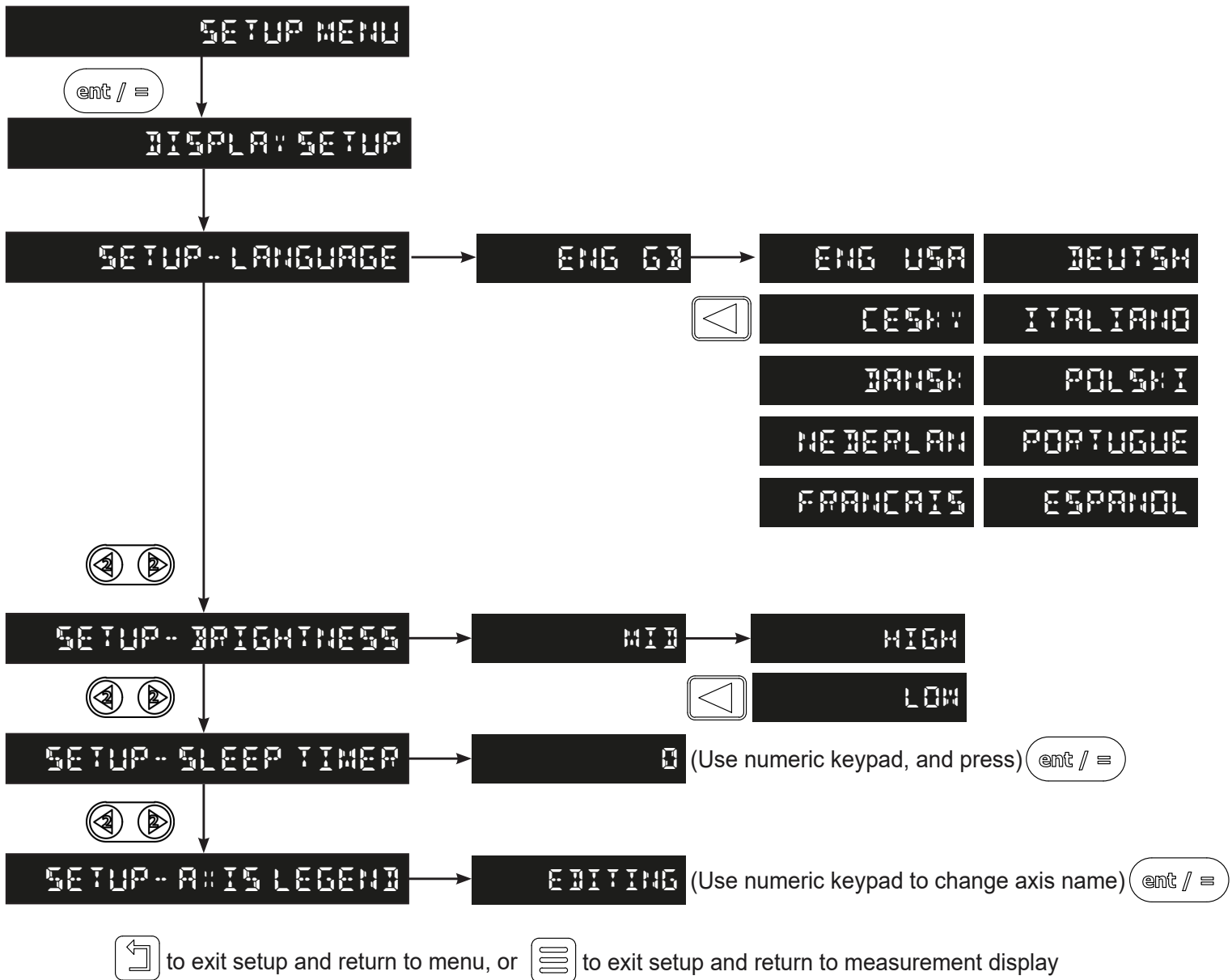

Setting up the unit

DRO Setup

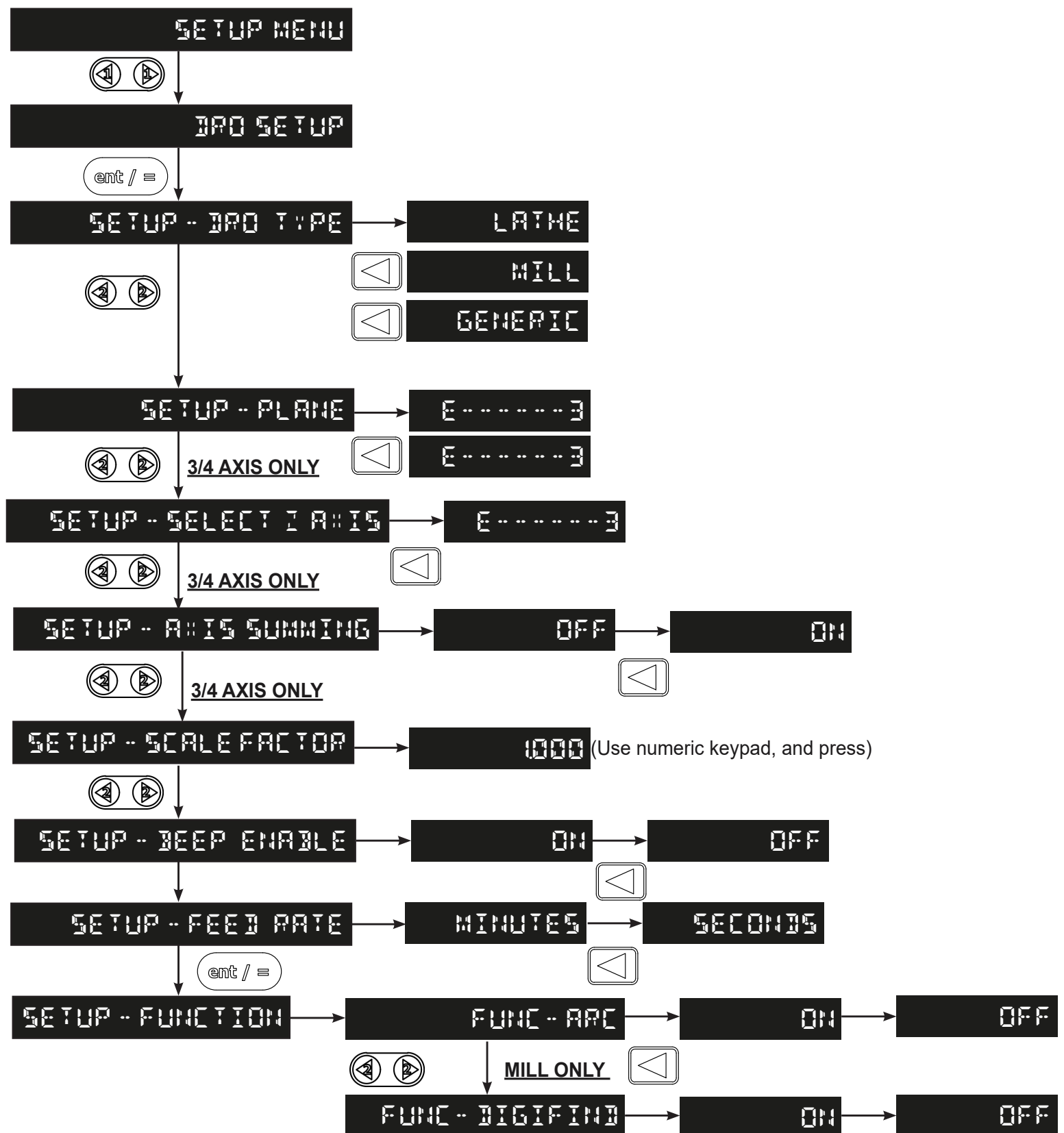

Setting up the unit

DRO Setup

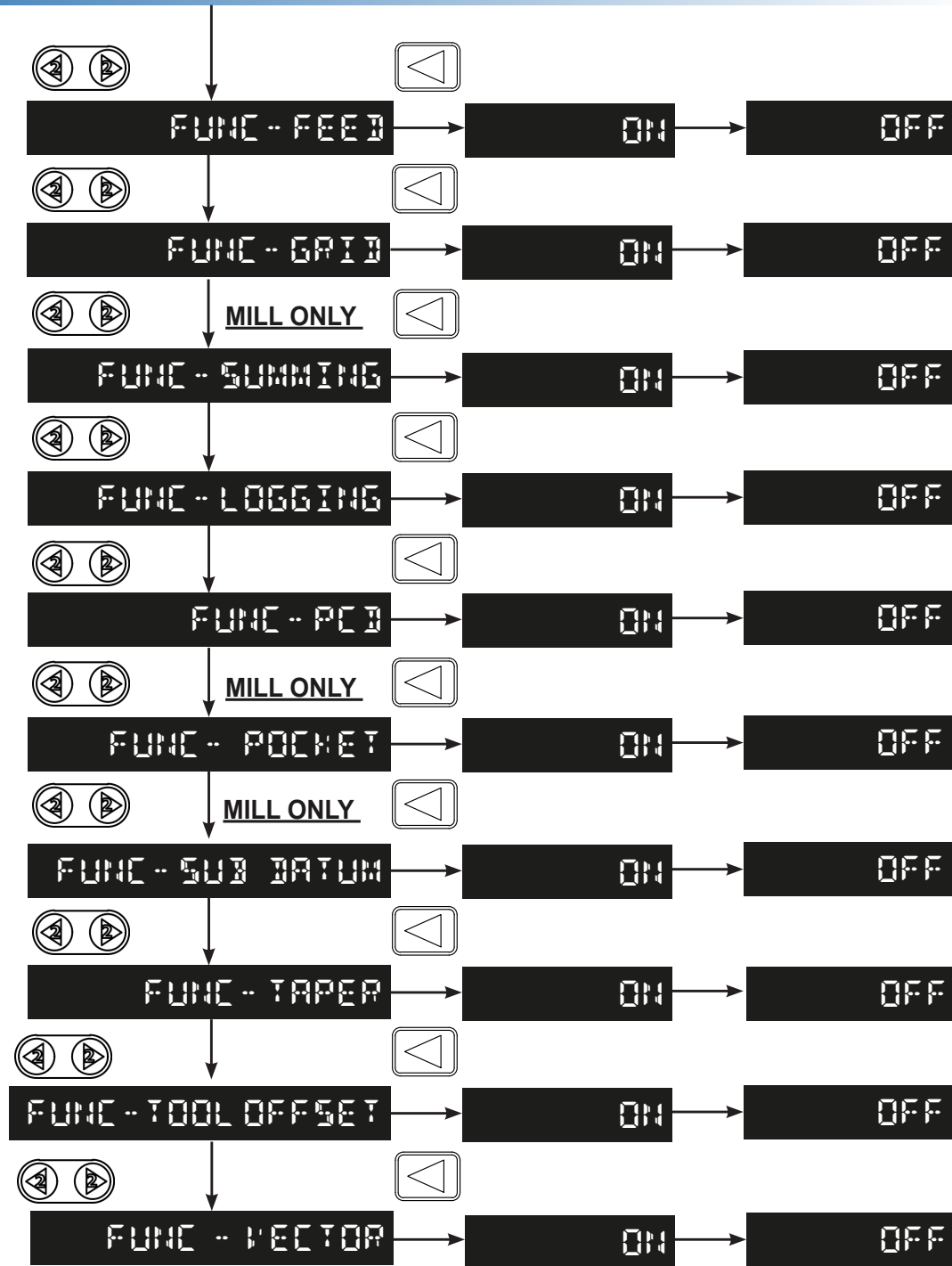

to exit setup and return to main menu, or



to exit setup and return to measurement display

Setting up the unit

Encoder Setup

SETUP MENU

ENCODER SETUP

ent / =

SETUP - DIGITAL TYPE

DIGITAL ONLY

ROT DEC (Rotary decimal)

ROT DMS (Rotary degrees, minutes and seconds)

ROT RPM (Rotary revolutions per minute)

LINEAR (Linear)

SETUP - ROTARY MODE

DIGITAL ONLY

CONTIN (Continuous)

ROLLOVER (Roll Over)

SETUP - DIGITAL RES

DIGITAL ONLY

360000

PROGRAM

TEACH

SETUP - GEAR RATIO

DIGITAL ONLY

ENTER VALUE

SETUP - QUAD INDE :

DIGITAL ONLY

ON

OFF

SETUP - SIGNAL CHECK

DIGITAL ONLY

SETUP - DISPLA: RES

0000 1

0005

00005

00 1

000 1

002

0002

005

PLEASE NOTE: 0.005, 0.01, 0.02, 0.05 are for digital only

Setting up the unit

Encoder setup (Continued)

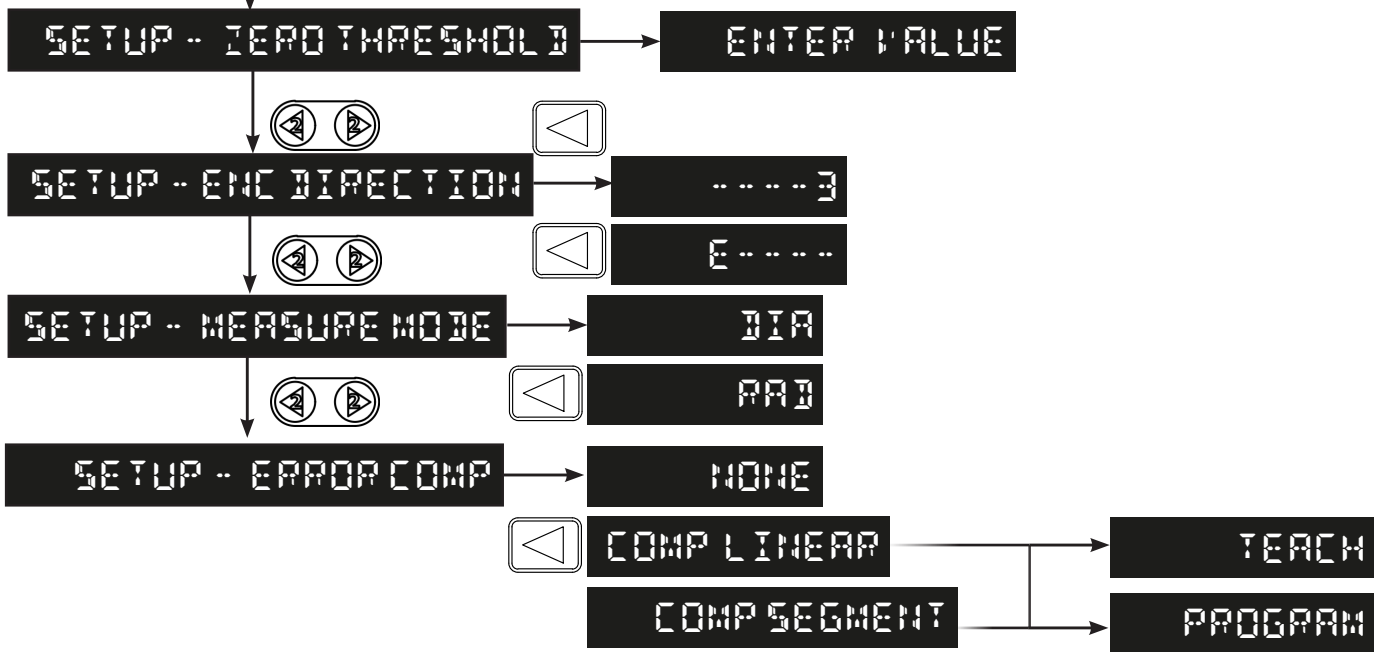

to exit setup and return to menu, or to exit setup and return to measurement display

Reset settings

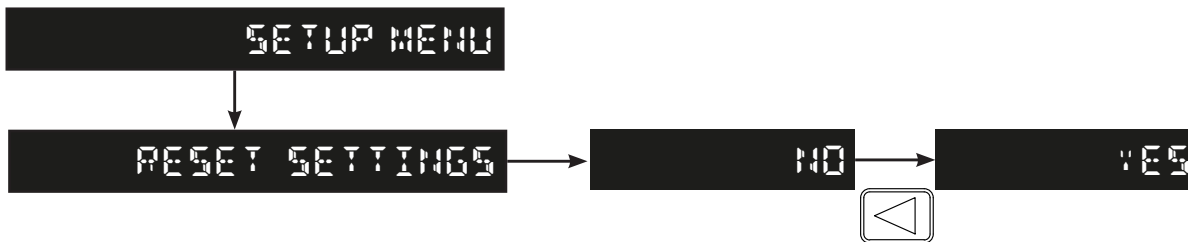

to exit setup and return to menu, or to exit setup and return to measurement display

REMINDER: To apply any changes, you must exit back through the menu.

Setting up the unit

Language Setup

This setting enables the user to choose the language that is required to be displayed in the NMS 800 display.

There are 13 language settings: **ENG GB** English UK (**Default**)

ENG US English US

FRANCAIS French

PORTUGUE Portuguese

CESH Czech

DEUTSH German

ESPAÑOL Spanish

DANSK Danish

ITALIANO Italian

NEDERLAND Dutch

POLSKI Polish

Press the axis select key  next to the axis to cycle through the options

Brightness Setup

This setting allows the user to alter the brightness of the display, this can be useful in varying ambient light conditions.

Settings available for brightness:

MID The default brightness is medium

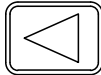
Press the axis select key  next to the axis to cycle through the options

HIGH Setting to high brightness increases the display brightness to its maximum

LOW Setting to low brightness decreases the display brightness to its minimum

Setting up the unit

Sleep Timer Setup

This setting enables the user to define an automatic sleep mode after a period of time. The user either leaves the default setting at '0' which deactivates the sleep mode, or selects a numeric value when the sleep mode is initiated after no operation of the NMS 800

To exit sleep mode, simply move an axis or press any key.

 The default setting is set to 0 minutes

To set the time, simply insert the number of minutes (using the numerical keypad) into the DRO and press 

 Sleep function active after 5 minutes`

Once input, simple press the undo key,  which will take you out of this menu.

Axis Legend setup

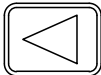
The axis legend setting allows you redefine all the axes on the DRO, using the  key to select which axis you would like to redefine.

The numeric keypad then allows you to add which letter you would like to label the axis with.



Once you've selected the axis, your screen will change to show editing.

Simply insert the letter you would like to be shown on this axis.

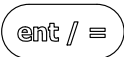







To apply, press the  key.

Setting up the unit

DRO Type setup

This setting enables the user to choose the machine type that the NMS800 operates with. This is important as the machine type defines the default functions for the [function keys](#) and [function menu](#).

There are two different settings for this DRO:

LATHE	MILL	GENERIC
 = Feed Function	 = PCD Function	 = PCD Function
 = Summing Function	 = Sub-Datum Function	 = Sub-Datum Function
 = Blank Function	 = Blank Function	 = Blank Function

Note: The function key can be manually set to any function desired, see the [function keys](#)

Scale Factor setup

The Scale factor setting on the NMS 800 allows you to scale the DRO to the travel on your lathe or milling machine. This can be set by entering your preferred scale using the numeric keypad.

When on the setting simply insert the scale factor required and hit the  key.

 This shows that the scale factor is set to 1:1 and will show the exact unit.

 This shows that the scale factor is set to 2:1 and will show double what the travel is.

 This shows that the scale factor is set to 5:1 and will show 5 times the travel.

Once input, simply press the undo key,  which will take you out of this menu.

Setting up the unit

Beep Enable setup

This DRO setting allows you to enable and disable any noise from the DRO. This function can be enabled or disabled through the DRO setup menu.

ON

This shows that the DRO will make a sound when keys are pressed.

OFF

This shows that the DRO will not make a sound when keys are pressed.

To cycle through these options, press the  key next to the 'x' axis and then  to exit.

Feed rate setup

The feed rate setting can be changed between minutes and seconds. These can be in both 'mm' and 'inch', these give the options of:

In/minutes, in/seconds, mm/minutes and mm/seconds. To set this press the  key.

MINUTES

This shows that the DRO is set to minutes.

SECONDS

This shows that the DRO is set to seconds.

To cycle through these options, press the  key next to the 'x' axis and then  to exit.

Function setup

The function setup allows you to scroll through all the different function on the NMS 800 and activate them within the DRO.

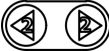
To scroll through the different setting press the  key.

ON

This shows that the function is on.

OFF

This shows that the function is off.

To cycle through these options, press the  key next to the 'x' axis and then  to exit.

Setting up the unit (Digital)

Digital type setup

The digital type setting is a very important setting to tell the NMS 800 which type of encoder your using with your machinery.

There are 4 options to use with the NMS 800: (These apply if more than one axes are digital)

ROT DEC

This shows that the DRO is for: Rotary decimal.

ROT DMS

This shows that the DRO is for: Rotary degrees, minutes and seconds.

ROT RPM

This shows that the DRO is for: Rotary revolutions per minute.

LINEAR

This shows that the DRO is for: Linear encoders.

To cycle through these options, press the  key next to the 'w' axis and then  to exit.

Rotary Mode setup

The Rotary mode setup allows you to change the NMS 800 between two settings. These are for when a rotary encoder is being used with this DRO.

The two settings are: (These apply if more then one axes are digital)

CONT IN

Continuous: This feature does not stop at 360° and will carry on past.

ROLLOVER

Roll over: This feature will stop at 360° and start back at 0°.

To cycle through these options, press the  key next to the 'w' axis and then  to exit.

Digital Res setup

The digital resolution feature is used for rotary encoders, this can be set to the resolution of the rotary encoder. Rotary encoder resolution is usually expressed as **PULSE PER TURN (PPT)**, this is the number of pulses output per revolution

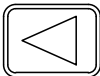
There is two ways to set this resolution, using  key to access these. The two are:

PROGRAM

Program allows you to input your resolution using the keypad.

TEACH

Teach, using a a reference mark on the encoder, will set the resolution on the NMS800.

Setting up the unit (Digital)

Digital Res setup teach

360000

Press the  key next to the "W" axis

DIGITAL RES



360000

Press the  key

TEACH

0

Rotate you rotary encoder untill you here two audible tones. this should have then set your DRO to the resolution of your encoder.

ROTATE AXIS

Signal Check setup

The signal check feature allow you to enable or disable the comparison of the encoder signal to the table shown below. If this setting is enabled, and the signal does not match the table below, it will return with a SIG-FAIL message. (If 1 or more axes are digital)

To cycle between these press the  key along the 'w' axis.

ON

This shows the signal check is enabled and will show an error.

OFF

This shows the signal check is disabled and will accept any signal.

Once set, press the  key to return.

When this setting is enabled, the NMS 800 will check for the different signals required. If the signal retrieved is an illegal signal, the DRO will return with SIG FAIL as shown in the table below. If a signal comes back and is correct, the DRO will continue as normal.

A	B	RM	STATUS
L	L	H	SIG FAIL
L	H	X	OK
H	L	X	OK
X	X	L	OK

X=Don't care state, L= Low state and H= High state.

Setting up the unit

Quad Index setup (Digital)

The quad index setting on the NMS800 activates the reference mark (Z). When this setting is off the DRO will only check for the A and B quadrature signals, but when this setting is activated, the DRO will check for A and B along with the Z quadrature signals.

The Two settings are:



This will be checking for A, B and Z

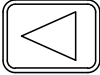

This will only check for A and B

Press the axis select key  next to the axis to cycle through the options

Display Resolution setup

The display resolution settings available for each axis can not be finer than the encoder resolution. The inch/mm setting will also define the resolution that is actually displayed as per the below table:

	Display	
	mm	in
μ		
0.1	0.0001	0.000004
0.5	0.0005	0.00002
1	0.001	0.00005
2	0.002	0.0001
5	0.005	0.0002
10	0.01	0.0005

NOTE - Resolution achievable is dependent on the encoder used.

Press the axis select key  next to the axis to cycle through the options

Gear Ratio

The Gear ratio setup allows you to scale your rotary encoder to any equipment in-between your encoder and your end product. The NMS 800 is set to a 1:1 ratio at factor settings.

You can change this ratio setting by pressing the  key, and entering a value using the numeric keypad.

NOTE - THIS FEATURE IS ONLY AVAILABLE WHEN A ROTARY ENCODER IS CONNECTED

Once set, press the  key to return.

Setting up the unit

Zero Threshold setup

Zero threshold is a visual indicator that helps the operator identify when approaching zero on the display. The zero threshold the maximum setting defines the band of where the visual indication begins. For example if the setting was 5mm, the visual indication will begin when moving negative from 5mm or moving positive from -5mm.

Settings available for zero approach max are:

mm setting (Metric)

1	+/- 1mm
2	+/- 2mm
3	+/- 3mm
5	+/- 5mm
10	+/- 10mm

Inch setting (Imperial)

004	+/- 0.04"
008	+/- 0.08"
01	+/- 0.1"
02	+/- 0.2"
04	+/- 0.4"

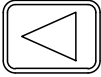
Press the axis select key  next to the axis to cycle through the options

When activating the Zero Threshold feature on the NMS800, you will be asked to input a value on the desired axis.



Enter the value you would like, and hit the 

Example - If you set the zero thresh to 0.00. Along the "Y" Axis shows when you are closer to your threshold.

The "Z" Axis shows when you are a good amount of distance out. The direction of the arrows show which way you need to move to get to your point.

The "W" Axis shows what your display will look like when you hit the threshold point.

NOTE - THIS FUNCTION IS ONLY AVAILABLE WITH 3/4 AXIS UNITS.

Setting up the unit

Plane Setup

The plane setting shows you currently which axes, or planes, are currently being summed together. You can change this so which ever axes that are required to be pairs.

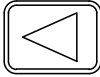
To change the axes which will be summed, press the  key.

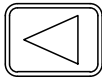

This screen currently shows that the 'X' and 'Y' axes are pairs together for summing.

Pressing the  key next to the 'X' axis on the

DRO will cycle the 'Y' axis down through the remaining axes.

Which ever the axis is highlighted when coming out of this menu will be pairs together and show the combined total of both encoders.

NOTE - THIS FUNCTION IS ONLY AVAILABLE WITH 3/4 AXIS UNITS.

Summing Setup

The summing setting on the NMS 800 allows your to activate whether the two axes, or planes, that you have selected with the Plane setting show as one unit on the DRO screen.

Press the axis select key  next to the axis to cycle through the options

 ON This shows the summing feature is activated and will show the total of the axes.

 OFF This shows the summing feature is disabled and will show each axes as is.

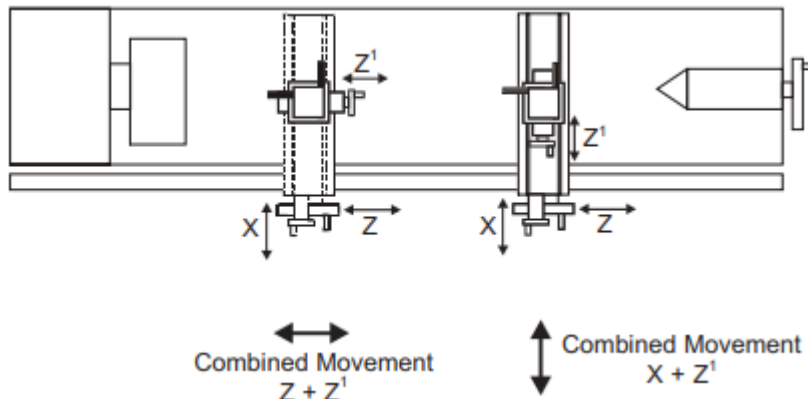

NOTE - THIS FUNCTION IS ONLY AVAILABLE WITH 3/4 AXIS UNITS.

Setting up the unit

Encoder Direction setup

This setting allows the user to match the NMS800 to the actual direction of travel of the axes fitted to the machine.

The two settings available for each axis are



and

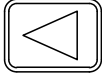

Press the axis select key  next to the axis to cycle through the options

Example:

If the current setting is and the travel is positive from right to left, changing the setting to will reverse the direction to measure positive from left to right

Measurement Mode setup

The radius /diameter function allows the user to display actual (radius) or twice-actual (diameter) measurements for each axis.

This function is generally used in turning applications, such as the cross travel on a lathe where the diameter reading is displayed rather than the radius.

There are two setting for each axis:

Radius

Diameter

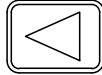
Press the axis select key  next to the 'X', 'Y' or 'Z' axis to cycle through the options

Error Compensation

The digital readout (DRO) system helps to improve productivity. It decreases the number of scrapped parts, as there is no concern about making mistakes related to counting the revolutions on the dials. The DRO system also helps to eliminate some errors related to ball-screw backlash.

The DRO system will operate to its published accuracy, provided all components are in working order and properly installed. Field calibration is not necessary.

Accuracy problems with machined parts may be caused by machine error, DRO system error, or a combination of both. The first step in determining the source of error is to check the DRO system. To do this compare the movement of the Newall reader head to the position reading shown on the display. A high accuracy standard, such as a laser interferometer is required. A dial indicator can be used to check short distances, but a laser provides the best results. If a dial indicator must be used, be sure it is the highest available accuracy.

Setting up the unit

Error Compensation Continued

To check the accuracy of the DRO system:

1. Place the target of the laser or the needle of the dial indicator directly on the Newall reader head. It is absolutely critical that the readings are taken directly from the Newall reader head. If a dial indicator must be used, be sure that the needle of the indicator is perpendicular to the reader head and not angled. If readings are taken anywhere else on the machine, machine errors may distort the results.
2. When the reader head moves, the movement registers on the laser / indicator and DRO display.
3. Set the laser / dial indicator and DRO position displays to 0.
4. Make a series of movements and compare the position readings between the laser / dial indicator and the DRO display. If the readings match within the accuracy specified, it proves that the DRO system is operating properly. If this is the case, proceed to the next step: evaluating the machine errors. If the readings do not match, the DRO system must be repaired before proceeding with error compensation.

To evaluate machine errors:

1. Put the laser target / dial indicator on the part of the machine where the machining is done.
2. Make a series of movements and compare the position readings between the laser / dial indicator and the DRO display. The difference between the laser / dial indicator reading and the reading on the DRO display is the machine error.
3. Plot the machine error along the entire axis of travel to determine the nature of the error. If it is a linear error, use linear error compensation. If the error is not linear, use segmented error compensation.

Types of Machine Error

There are many types of machine error, including pitch, roll, yaw, flatness, straightness, and Abbé error. The diagrams below demonstrate these errors.

Way errors

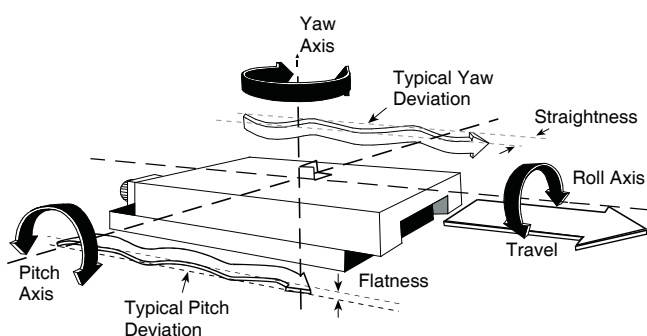

Abbé error

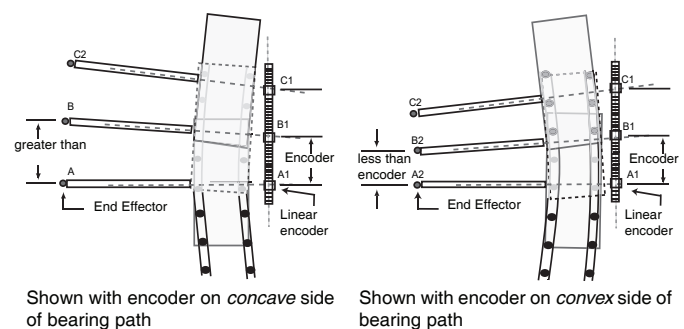

Setting up the unit

Linear Error Compensation

In this mode, a single constant correction factor is applied for each axis for all displayed measurements. Calculate the correction factor, and specify it in parts per million (ppm).

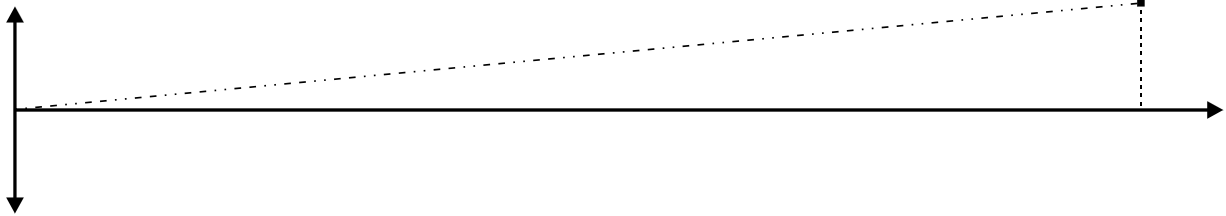

When following the procedure ensure that a stepped standard is used, and approach each edge from the same direction; or if each edge must be approached from opposite directions, then subtract the width of the tool or measuring probe from the value displayed on the NMS300.

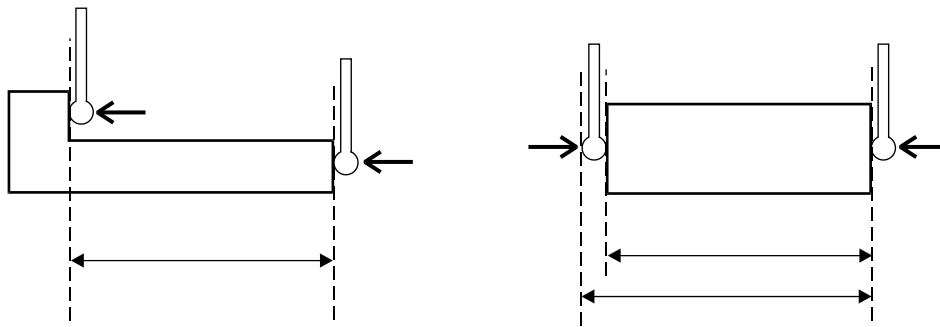

Segmented Error Compensation

The scale travel is broken down into as many as 200 user-defined segments, each with their own correction factor, measured against a high-accuracy standard. The following parameters need to be identified:

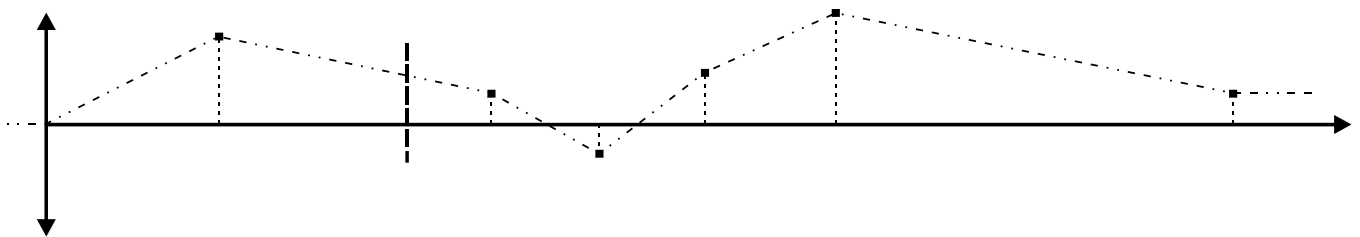

Each Correction Point is measured with respect to the Starting Point - zero - which is usually set close to one end of the scale. The Reference Point can be set anywhere along the scale, and does not need to coincide with either the absolute datum or any of the correction points.

However, it may be convenient to make the absolute datum and the reference point the same.

Always approach the Starting Point, Correction Points and Reference Point from the same direction. If not, then the size of the tool or probe will render the measurement inaccurate.

Setting up the unit

Teach Mode

Teach mode is an easier way of calculating linear errors by using the NMS800 to automatically calculate the error. This is achieved by comparing the actual measurement and the physical movement. The procedure to do this is shown below.

Navigate to the Error compensation selection screen 

The default value for each of the axis is 

Navigate to the Error compensation selection screen 

The default value for each of the axis is 

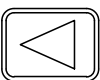

When wanting to change each axes, press the  key to take you to the options.

The three options are:





 No error compensation is in use

 Point to point error compensation

 Multiple point error compensation

Once you have selected the option you will get the option of teach or program. Use the   key to select the teach option.

 last compensation value calculated / used

   to choose teach rather than program 

 encoder position (start point)

 

 encoder position (end point)

Setting up the unit

Teach Mode Continued

TCH 1- MOVEMENT enter the actual measurement using the numeric keypad 

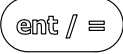
1000500 value entered in previous step

TCH 1- MOVEMENT 

-500 Linear compensation value (ppm)

TCH 1- ACCEPT 

-500

LIN 1- TEACH

To exit setup and return to menu, or  to exit setup and return to measurement display

Program Mode

Program mode allows the linear compensation to be calculated manually and then entered as a PPM value into the NMS800 display.

The procedure to do this is shown below:

To illustrate the calculation an example is being used where the standard distance is 500.000mm and the measured distance is 500.200mm.

Correction factor = error / actual x 1,000,000

Correction factor = (500.000 - 500.200) / 500.000 x 1,000,000

Correction factor = -400 PPM

To enter this value into the display:

Navigate to the Error compensation selection screen **SETUP- ERR COMP**

The default value for each of the axis is **none**

Navigate to the Error compensation selection screen **SETUP- ERR COMP**



The default value for each of the axis is **none**

Setting up the unit

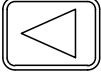
Program Mode Continued

When wanting to change each axes, press the  key to take you to the options.

When selected choose whether you need teach or program, select program.

  to choose program rather than teach 

 Correction point position

 Correction value (compensation)

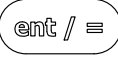
Note: Pressing  will delete both correction point position and correction value (Set to 0) to move to segment 2 and the repeat the process above

 to exit setup and return to menu, or  to exit setup and return to measurement display

When segmented compensation is enabled it is necessary to move to a start / reference point when the unit has had its power cycled. The below message will be shown on the NMS300 display when this is required.

 



Reset Setup

This setting enables the NMS800 to be reset to its default parameters.

WARNING:: Enabling this setting will erase any data that was previously stored in the functions and settings of the readout.

 Navigate to this message display in settings

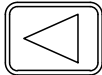
  Confirm that a reset is required by pressing the axis key



to exit setup and return to menu, or  to exit setup and return to measurement display







Setting up the unit

Notes

Standard functions

Function Menu

FUNC - ARC

Arc contouring function - Generic & Mill

FUNC - DIGIFIND

Digifind reference function - Generic, Mill and Lathe

FUNC - FEED

Feed rate function - Generic, Mill and Lathe

FUNC - GRID

Grid Hole Function - Generic & Mill

FUNC - SUMMING

Summing function - Generic, Mill & Lathe

FUNC - LOGGING

Logging function - Generic, Mill & Lathe (**ONLY SELECT MODELS**)

FUNC - TOOL COMP

Tool Compensation function - Generic, Mill & lathe

FUNC - PC

Pitch Circle Diameter / bolt-hole function - Generic & Mill

FUNC - POCKET

Pocket or island milling - Generic & Mill

FUNC - SUB DATUM

Sub datum memory Function - Generic, Mill & Lathe

FUNC - TAPPER

Tapper turning - Generic & Lathe

FUNC - TOOL OFFSET

Tool offsets - Generic, Mill & Lathe

FUNC - VECTOR

Vector Function - Generic, Mill (**ONLY 3/4 AXIS**)

Standard functions

Absolute / Incremental

Press the  key to toggle between absolute and incremental modes.

The NMS800 has a dedicated key to switch the positional displays between absolute (abs) and incremental (inc) measurements. The current display mode is indicated at the bottom of the screen as shown on the right.



Absolute (abs) mode has been selected



Incremental (inc) mode has been selected



Using incremental mode

In Incremental mode the DRO displays the position relative to the last position. This is also known as point-to-point use. In this mode set the value for each axis, or zero it to create an Incremental datum. This does not effect the machine's Absolute datum that is configured in Absolute mode.

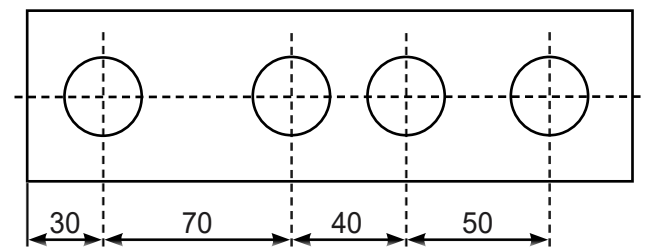

Using absolute mode

In Absolute mode the DRO displays the positions of all the axes with respect to a fixed datum. The datum is set by entering an axis position when in Absolute mode.

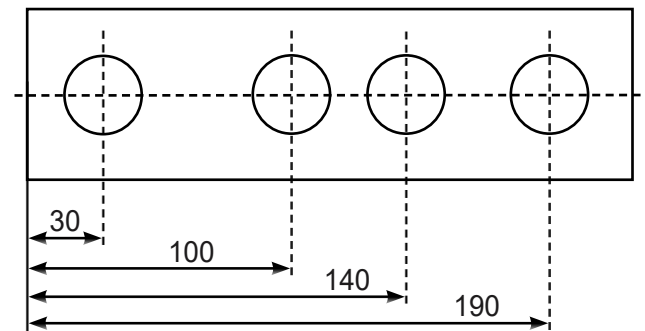

Example of absolute and incremental use

Set absolute zero at lower left corner of the part

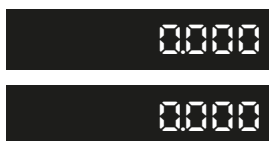

Move to first position in ABS (hole A)

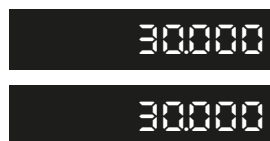

Move to second position in ABS (hole B)

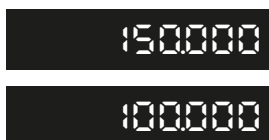

Switch to incremental mode and zero the display



Make an incremental move to hole C

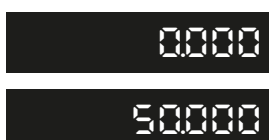

Switch to absolute mode

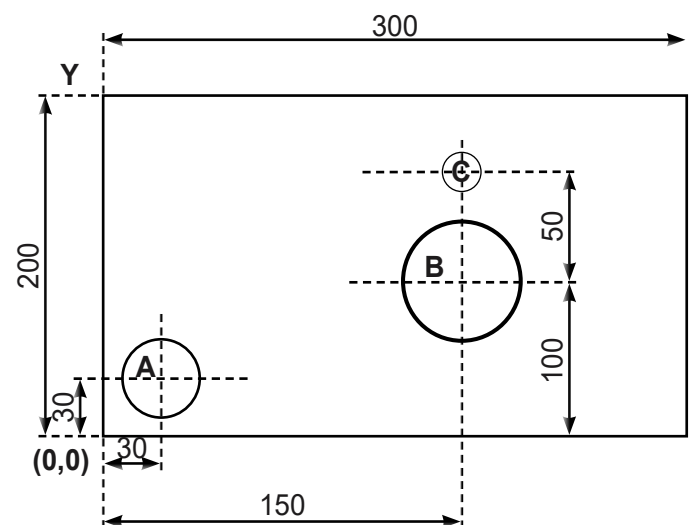
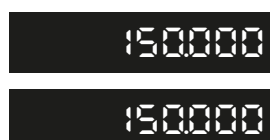

Standard functions

Zero and Pre-set an Axis

Press  to toggle between set and zero modes.

The NMS800 has a dedicated key to switch the operation of the axis selection key between zero and set modes. The currently selected mode is indicated at the bottom right of the screen as shown.

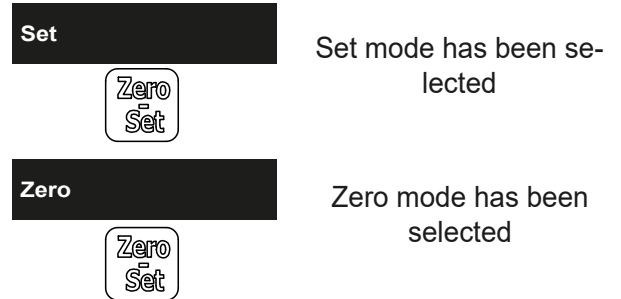

Using set mode

With the set mode selected, the select axis key prompts a numeric entry into the desired axis.

Once the correct value has been selected, it can be set into the axis by pressing the enter key. This can be seen in the example on the right.

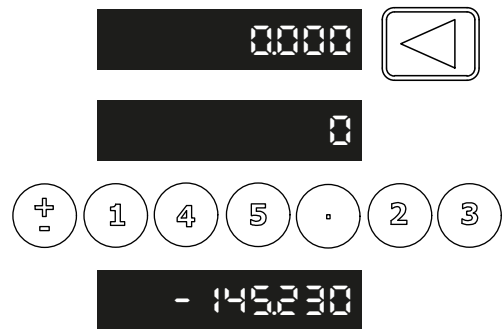

Zeroing an axis in set mode

With set mode selected, it is possible to zero an axis conveniently by holding down the axis select key for at least 3 seconds. This allows the user to zero an axis but stay in the pre-set mode. Use of this feature can be seen in the example on the right.

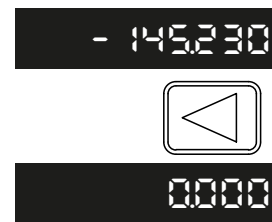

Using zero mode

With zero mode selected, this enables the select axis keys to zero each axis independently. This can be seen in the example on the right.

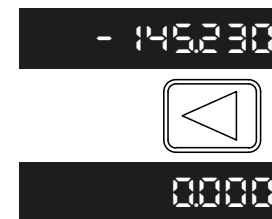

Inch and mm Modes

Press  to toggle between Inch and mm measurement modes.

The NMS800 has a dedicated key to switch the positional displays between imperial (inch) and metric (mm) measurements. The current display mode is indicated at the bottom left of the screen as shown right.

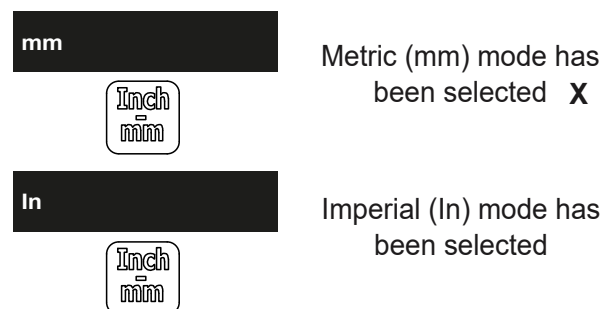

Standard functions

Digifind / reference function

NOTE: THIS FUNCTION WILL ONLY FUNCTION WHEN YOUR NMS800 IS IN ABSOLUTE MODE

The NMS800 comes equipped with Digifind, a feature unique to Newall digital readout products. Digifind eliminates the risk of losing position and datum Set-Up. With Digifind, precise Set-Up of a work-piece is carried out only one time. When the NMS800 is powered on, it displays the position at power off, compensated for any movement of a Spherosyn encoder up to 0.2500" (6mm) and a Microsyn encoder up to 0.1000" (2.5mm) in either direction since the unit was last used. If the machine has moved beyond 0.2500" (6mm) - Spherosyn [0.1000" (2.5mm) - Microsyn], Digifind allows a quick means to find the datum if lost.

A mark must be made on both a stationary part and moving part of the machine. The marks must be aligned and will serve as the machine "home" position.

The mark must be indelible, and it must allow the operator to move the machine to within a 0.2500" (6 mm) - Spherosyn [0.1000" (2.5mm) - Microsyn] band around the mark at any time. Alternatively, use a convenient reference point on the work-piece.

To use digifind one of the function keys must be assigned to the digifind function - see the section function keys

Setting the reference

Press the function key that has been assigned to digifind, (in this example the digifind has been assigned to the F3 key).

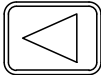

Press the axis select key  next to the 'X', 'Y' or 'Z' axis that requires the reference setting.

Finding the reference ``

If the reference is lost at anytime it is possible to 'find' the reference again. Position the machine to within 6mm (0.2500") band for Spherosyn and 2.5mm (0.1000") band for Microsyn. Press the function key that has been assigned to digifind, (in this example the digifind has been assigned to the F3 key).



Press the axis select key  next to the 'X', 'Y' or 'Z' axis that requires the reference to be found.

Finding zero

If the datum is lost at anytime it is possible to 'find' the datum again. Position the machine to within 6mm (0.2500") band for Spherosyn and 2.5mm (0.1000") band for Microsyn. Press the function key that has been assigned to digifind, (in this example the digifind has been assigned to the F3 key).

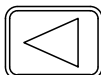

Press the axis select key  next to the 'X', 'Y' or 'Z' axis that requires the reference setting.

NOTE - WHEN USING THE REFERENCE, THE VALUE YOU HAVE INPUT WILL BE YOUR RETURN DATUM.
- WHEN USING FINDING ZERO. ZERO WILL BE YOUR RETURN DATUM

Standard functions

Sub datums / memory

The NMS800 can store up to **200 SDM** (Sub-Datum) positions, or machining steps into the memory. Using SDM allows the operator to work to zero by calling up stored dimensions, instead of “working up” to drawing dimensions. This eliminates the need to constantly refer to the drawing, and reduces the possibility of scrapping parts due to misread dimensions. It also speeds up positioning because the operator works to zero.

The SDMs are stored as co-ordinates relative to the current absolute / incremental datum position. If the absolute / incremental datum position changes, the SDMs will “shift” to the new datum.

Once a repetitive sequence of co-ordinates is entered into SDM, the co-ordinates can be recalled at any time. The positions remain in memory until altered by the operator. Simply assign any SDM number **1 - 200** to each machining step. When machining, call up each step (SDM) number and work to zero.

There are two ways to store Sub datums, Teach mode and program mode. See example on the next page:

To use sub datums one of the function keys must be assigned to the sub datum (SDM) function - see the section function keys

Teach Mode

To use sub datums one of the function keys must be assigned to the sub datum (SDM) function - see the section function keys

Press the function key that has been assigned to sub datums, (in this example the sub datum has been assigned to the F2 key).



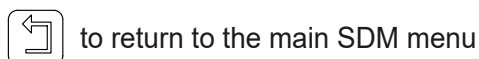
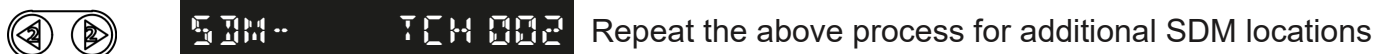

Move the axis 'X', 'Y' and/or 'Z' to the 1st location



Program Mode

Press the function key that has been assigned to sub datums, (in this example the sub datum has been assigned to the F2 key).

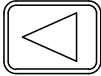

Press the axis select key  next to the 'X', 'Y' or 'Z' axis that requires the position setting, enter the dimension using the numeric keypad. 

Note: Pressing  will delete all offset values displayed (Set to 0)

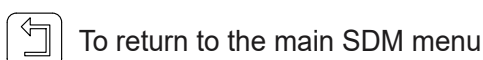
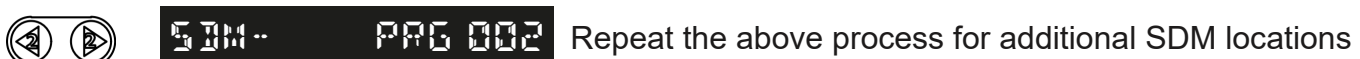

Standard functions

Delete Mode

Press the function key that has been assigned to sub datums, (in this example the sub datum has been assigned to the F2 key).

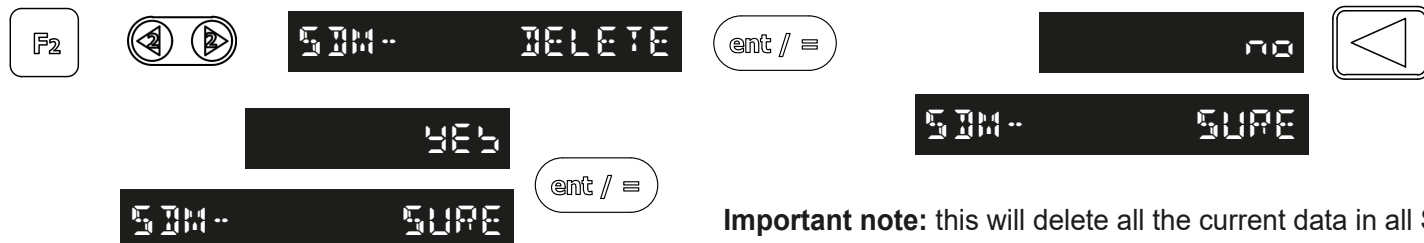

Important note: this will delete all the current data in all SDM's

Use Mode

Press the function key that has been assigned to sub datums, (in this example the sub datum has been assigned to the F2 key).

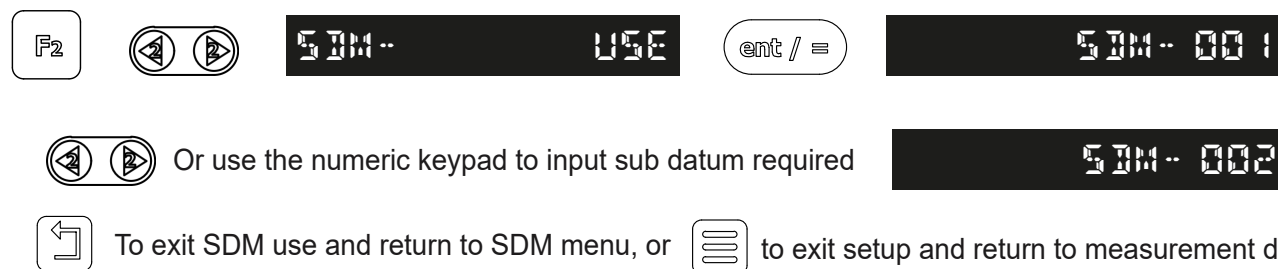

Or use the numeric keypad to input sub datum required

To exit SDM use and return to SDM menu, or to exit setup and return to measurement display

The function can also be exited by pressing the function key that has been assigned to sub datums

Feed Rate Function

To use the feed rate function one of the function keys must be assigned to feed - see the section function keys

Press the function key that has been assigned to feed, (in this example feed has been assigned to the F2 key).

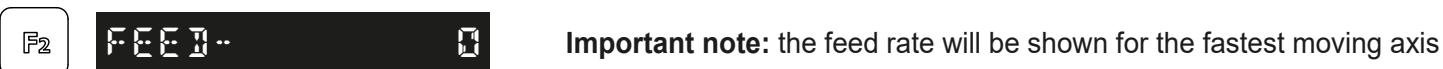

Important note: the feed rate will be shown for the fastest moving axis

Tool Offsets

To use tool offsets feature, simple hit the  key (short press).

This will then take you to the tool offset function menu which you then press the key next to the "X" axis.

A long press of this key will turn off the tool offset function.

The NMS800 can store up to 50 tool offsets, this large number allows tools to be grouped where more than one set is used. For convenience, it is highly recommended that tools are physically marked with their corresponding tool number. There are multiple ways to set tool offsets, teach mode, program mode and quick edit mode.

Note: Once tools are enabled they stay enabled even when other functions are used, until disabled.

Standard functions

Teach Mode

TEACH MODE IS ONLY ACTIVE WHEN YOUR DRO IS IN LATHE MODE
THE UNIT MUST NOT BE IN "USE TOOL" MODE TO TEACH.

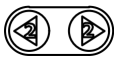

TOOL -- TEACH



TOOL -- TCH 01

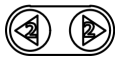

to select different tool

Take a skim cut with X and/or a face cut with Z  to capture all axes

TOOL -- CAPTURED

Note: to capture a single axis press the axis select key instead of the enter key

Display will now show

0.000

0.000

TOOL -- VALUE

Note: at this point the tool can be moved away from the part

Measure the part with an accurate gauge and enter this value into the relevant axis

Repeat the process above for all other tools required

To return to the previous tools menu, or  to exit tools menu and return to measurement display

Program Mode

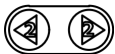

TOOL -- PROGRAM

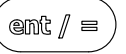

0.000

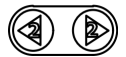

To select different tool

TOOL -- PRG 01

Note: Pressing  will delete all offset values displayed (Set to 0)

Take a skim cut with X and/or a face cut with Z

Note: at this point the tool can not be moved away from the part

Measure the part with an accurate gauge and enter the difference between the measured diameter and the readout value into the relevant axis (see using [set mode page 22](#))

Repeat the process above for all other tools required

to return to the previous tools menu, or  to exit tools menu and return to measurement display

Use Mode



TOOL -- USE

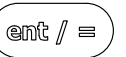

TL -- 01

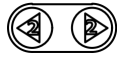

to select different tool

Note: Different tools can be selected by entering the tool number required using the numeric keypad

Standard functions

Quick Edit Mode

While in the using tool offsets mode tools can be edited / created quickly, without having to go back through the tool program or teach modes. The procedure to do this is demonstrated below:

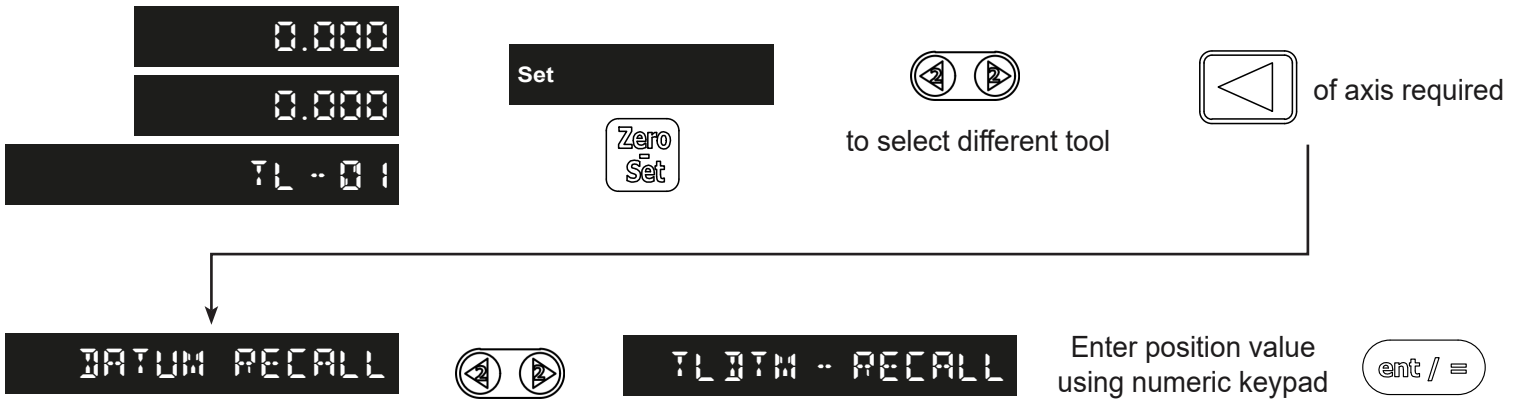

Repeat the above process for other axes or tools

Delete mode

This function is designed to delete **ALL** the tool offsets, if one tool is to be changed quick tool edit should be used.

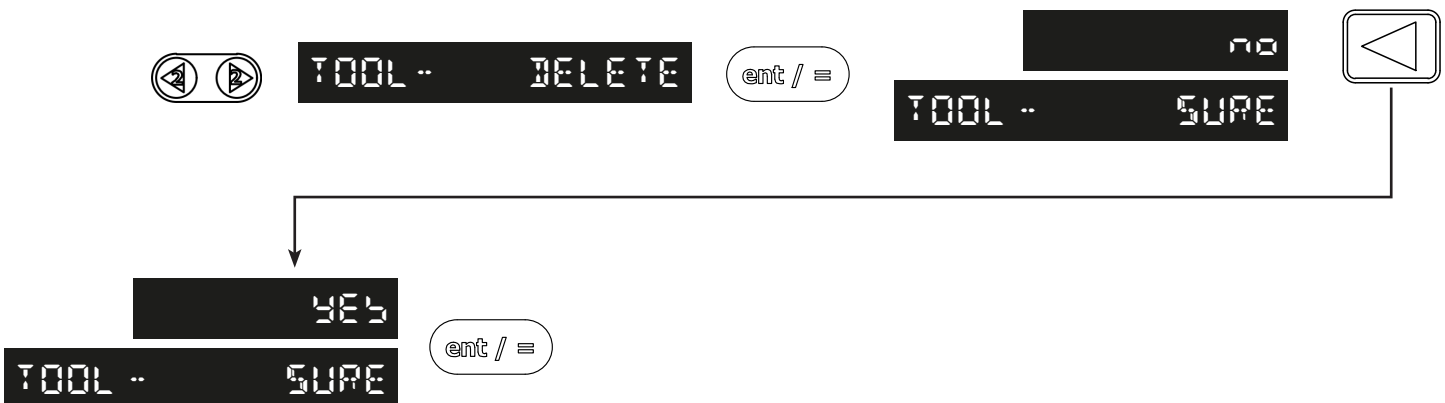

Standard functions

Logging Function (ONLY SELECT VARIANTS)

The NMS800 readout is capable of offering basic serial communications via a dedicated hardware RS232 compatible port, This is only used for output purposes and is how the logging function operates.

The communication parameters for the NMS800 are: 115200 baud, no parity, 1 stop bit, 8 data bit.

Logging Connection (RS232)

On the back of the NMS800 is a 15 way D female connector that is used to allow logging data to be output to another compatible RS232 device. The connections required to make this happen are detailed below:

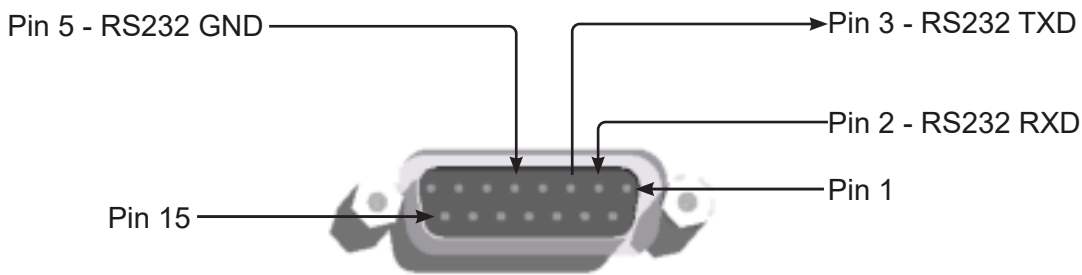

A serial cable is available from Newall, please quote part number 307-83210 when contacting your local Newall supplier for more details.

Using the Logging Function

Whilst using the logging function you will have the option between two output types “ENT” and “PERIODIC”

To change between these two output types simply press the  Key.

Ent

This output type is “ENT” or enter allowing logging every time the  key is hit.

OUTPUT TYPE

PERIODIC

This output type is periodic, this allows you to set a logging function every set time.

OUTPUT TYPE



1000

The imputed figure shows how many seconds are in between logging, this is set to 10 seconds

PERIOD





to exit setup and return to main menu, or



to exit setup and return to measurement display

Mill functions

Arc contouring

To use arc contouring one of the function keys must be assigned to the arc contouring function - see the section function keys. Press the function key that has been assigned to arc contouring, (in this example arc contouring has been assigned to the F3 key).

The NMS800 calculates positions for a series of equally spaced holes in an arc. The message display prompts the user for various parameters it needs to do the calculations.

Once the NMS800 completes the calculations, the axis displays show the distance to each hole. The operator works to zero for each hole location. See example below.

ARC - CENTRE

Enter centre co-ordinate

3.35000

ent / =

2.36000

ARC - START

Enter start co-ordinate

2.25000

ent / =

4.82600

ARC - END

Enter end co-ordinate

5.35000

ent / =

4.17400

ARC - RADIUS

Enter the radius of the arc

2.70000

ent / =

ARC - TOOL DIA

Enter the tool diameter being used

0.50000

ent / =

ARC - MAX OFFSET

Enter the maximum cut required

0.15000

ent / =

ARC - CUT TYPE

Enter the cut type required

int

ent / =

RUN FUNCTION



At any stage the   keys will move back and forth through the above menus to

Make any further adjustments, if the settings are OK then press 

-2.3520

-4.5974

ARC - HOLE 001

Navigate through the sequence of holes by using  

Alternatively use the numeric keypad to select the hole required.

The maximum number of holes for this function is 999

To exit line hole use and return to line hole menu, or

To exit line hole and return to measurement display

The function can also be exited by pressing the function key that has been assigned to line hole

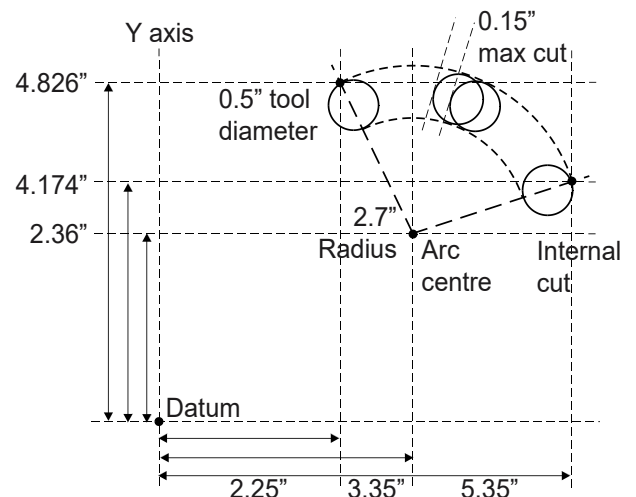

Mill functions

Pocket / Island Milling

To use pocket milling one of the function keys must be assigned to the pocket milling function - see the section function keys. Press the function key that has been assigned to pocket milling, (in this example pocket milling has been assigned to the F1 key).

The NMS800 calculates positions for each corner of pocket / island required. The message display prompts the user for various parameters it needs to complete the calculations.

Once the NMS800 completes the calculations, the axis displays show the distance of each corner from the datum. The operator works to zero to complete a circumference cut of the pocket / island. See example below.

350.000
400.000
PCHT - CENTRE

Enter centre co-ordinate

200.000
200.000
PCHT - DIMENSION

Enter Dimension of the pocket / island required

8.000
PCHT - TOOL DIA



Enter the tool diameter being used

int
PCHT - CUT TYPE

Enter the cut type

PCHT - RUNFUNCTION

PCHT - GO

At any stage the   keys will move back and forth through the above menus to make any further adjustments, if the settings are OK then press

-254.000
-304.000
PCHT - POINT 1

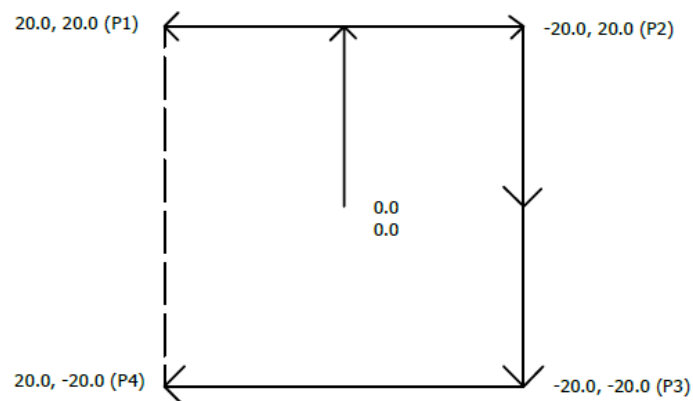

Navigate through the sequence of corners by using

Alternatively use the numeric keypad to select the corner required. The number of pocket points will always be 4 it is expected the user will reach point 4 and move on to point 1 to complete the pattern



To exit line hole use and return to line hole menu, or



To exit line hole and return to measurement display

The function can also be exited by pressing the function key that has been assigned to line hole



Mill functions

PCD / bolt hole circle

To use PCD / bolt hole circle one of the function keys must be assigned to the PCD function - see the section function keys. Press the function key that has been assigned to PCD, (in this example the PCD has been assigned to the F2 key).

The NMS800 calculates positions for a series of equally spaced holes around the circumference of a circle. The message display prompts the user for various parameters it needs to do the calculations.

Once the NMS800 completes the calculations, the axis displays show the distance to each hole. The operator works to zero for each hole location. See example below.

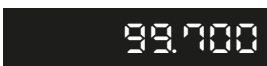
  Enter centre co-ordinate

 CENTRE 

 Enter diameter value

 DIAMETER 





 Enter the number of holes

 HOLES 

 Enter the start angle

 ANGLE 

Important note: The PCD will be calculated from the 3 O'clock position, anti-clockwise. Enter the angle as a negative value if it is given as clockwise from the 3 O'clock position.

 At any stage the   keys will move back and forth through the above menus to make any further adjustments, if the settings are OK then press 



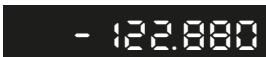

 HOLE 1

Navigate through the sequence of holes by using  

Alternatively use the numeric keypad to select the hole required.

The maximum number of holes for this function is 999

to exit PCD use and return to PCD menu, or

to exit PCD and return to measurement display

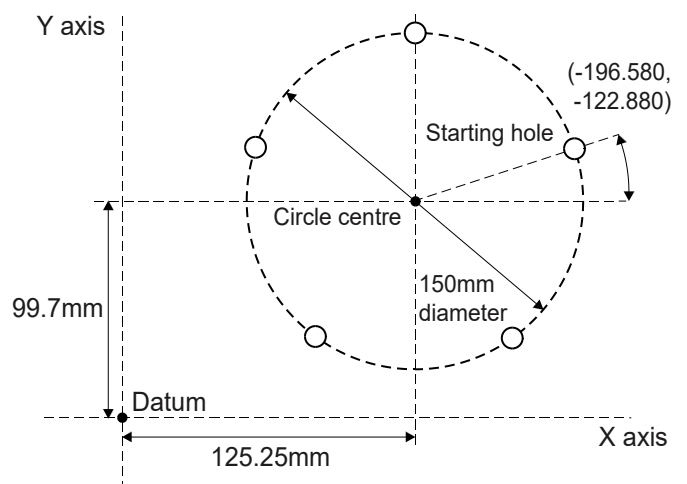

The function can also be exited by pressing the function key that has been assigned to PCD





Mill functions

Grid





To use grid, one of the function keys must be assigned to the grid function - see the section function keys. Press the function key that has been assigned to line hole, (in this example the line hole has been assigned to the F3 key).

The NMS800 calculates positions for a series of equally spaced holes in a grid. The message display prompts the user for various parameters it needs to do the calculations.

Once the NMS800 completes the calculations, the axis displays show the distance to each hole. The operator works to zero for each hole location. See example below.



 

 

Enter starting co-ordinate of where you want your grid to start.

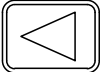

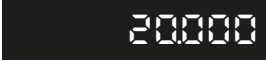
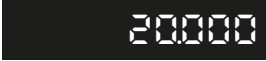

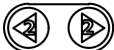

Enter the number of holes required for your grid on the "X" and "Y" axis.

To change the number press the  next to the axis, and use the keypad.

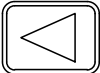

 

Enter the dimensions of the outer perimeter of the Grid.

To change the number press the  next to the axis, and use the keypad.

Enter the angle you would like the grid to be at.

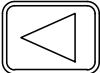
To change the number press the  next to the axis, and use the keypad.

Use the  key to scroll through all holes that the NMS800 has worked out for you

For each hole, you will take the readout down to zero and drill your holes.

Lathe functions

Vecor

Vectoring combines the movement of the "X" and "Z" axis with the angle of the compound

NOTE: THIS FUNCTION IS ONLY AVAILABLE ON 3 AND 4 AXIS UNITS

If the compound is set at an angle, vector is the function you need. If the compound is aligned with the "X" or "Z" axis, then the summing function should be used.

30.000

Enter the desired vector angle using the keypad

ANGLE

ent / =

Once hitting the **ent / =** this will take you back to the home page and show the vector is running.

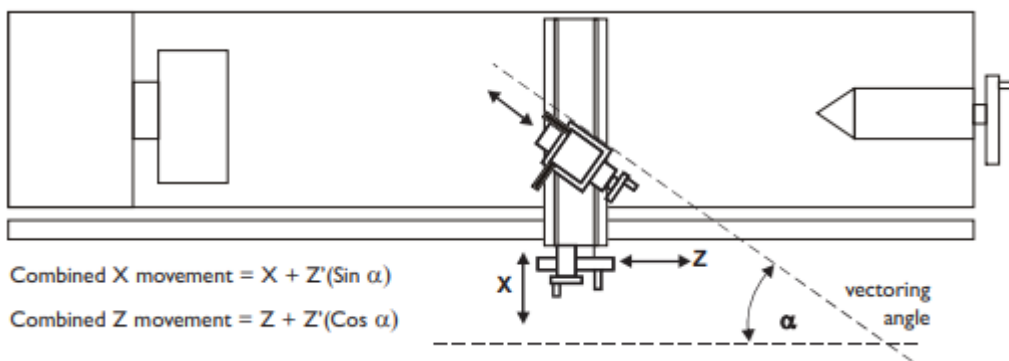

Taper Turning

To use the taper one of the function keys must be assigned to the taper function - see the section function keys. Press the function key that has been assigned to taper, (in this example taper has been assigned to the F2 key).

The taper function shows the angular displacement of the displayed (X,Z) position.

touch tool to one end of the taper and zero both axes, then touch the tool on the other end of the taper.

10.000

50.000

TAPER 11.30993

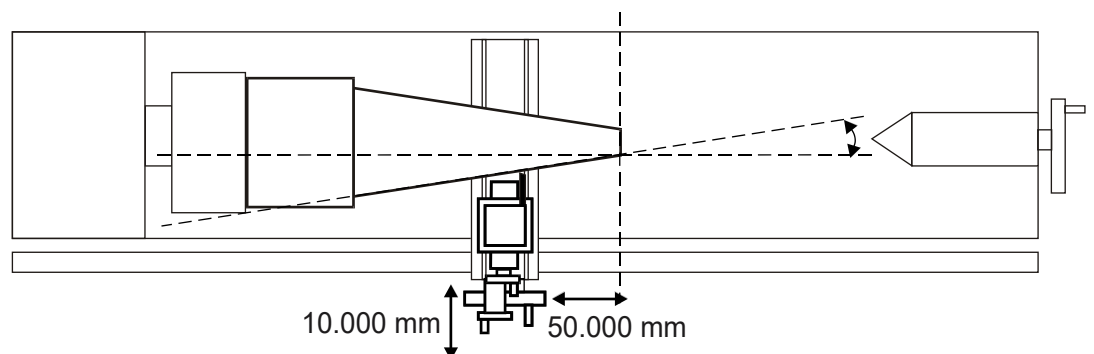

Trouble shooting guide

Symptom	Solution
The display is blank	<ul style="list-style-type: none"> • The NMS800 maybe in sleep mode. Press any key to exit sleep mode • Check that the power supply is correctly connected to a working mains outlet • Check that the power supply cables are not damaged • Check that the power supply voltage is 15 - 24Vdc \pm10%
The display works, but resets from time to time without any keys being pressed.	<p>Either the supply voltage is too low, or the power supply or mains supply has an intermittent fault.</p> <ul style="list-style-type: none"> • Check that the power supply voltage is 15 - 24Vdc \pm10%. • Check that all the connections are secure.
The display works, but gives erratic readings, the last digit jitters or the measurements jump to new figures unexpectedly.	<p>There may be a poor earth (ground) connection. Both the NMS800, and the machine on which it is installed, must have proper earth (ground) connections.</p> <p>There may be a problem with the encoder.</p>
The unit does not respond to any key presses.	Disconnect the NMS800 from its power supply, wait 15 seconds and then reconnect.
'NO Sig' / 'SIG FAIL' or '1.x' appears in the display.	<p>This indicates that the unit is not receiving a proper signal from the encoder.</p> <ul style="list-style-type: none"> • Check that the encoder connections are secure. • Check that there is no damage to the connectors or to the encoder. • Switch the NMS800 off and back on again.
Readings are incorrect.	<ul style="list-style-type: none"> • Check the Encoder Type to ensure it is correct. • Check the resolution set in NMS800 matches the encoder connected. • Check a scaling factor has not been set in the NMS800. • Check the Error Compensation factors. • Check that there is no damage to the encoder or its cable. • Check that the encoder is fixed firmly and aligned correctly, as described in the Spherosyn / Microsyn Installation manual. • Check that there is no binding on the scale. With the scale brackets slightly loosened, you should be able to slide the scale back and forth with minimal resistance. • If a Spherosyn scale is in use, check that the scale is not bent, by removing it and rolling it on a flat surface.

If the solutions suggested above do not solve the problem, contact Newall for further instruction

NEWALL

EUROPE & ASIA PACIFIC

Newall Measurement Systems Ltd.
Unit 1 Wharf Way Business Park,
Wharf Way, Glen Parva,
Leicester LE2 9UT
United Kingdom
Tel: +44 (0) 116 264 2730
Fax: +44 (0) 116 264 2731
E-mail: sales@newall.co.uk
Web: www.newall.co.uk

AMERICAS

Newall Electronics Inc.
1803 O'Brien St.
Columbus, Ohio 43228 USA
Tel: +1 614 771 0213
Fax: +1 614 771 0219

SALES & SERVICE:

A Tech Authority, Inc.
13745 Stockton Ave.
Chino CA 91710
909-614-4522
sales@atechauthority.com

More information at sales@newall.com • www.newall.com

