

SALES & SERVICE:

A Tech Authority, Inc.
13745 Stockton Ave.
Chino CA 91710
909-614-4522
sales@atechauthority.com



PRODUCT CATALOG

SALES & SERVICE:

A Tech Authority, Inc.
13745 Stockton Ave.
Chino CA 91710
909-614-4522
sales@atechauthority.com

April 2022

Table of Contents



M2 Threads.....	4
M3 Threads.....	17
M3 XXT titanium technology.....	26
M4 Threads.....	33
M5 Threads.....	37
Blum Compatible Parts.....	66
Faro Compatible Parts.....	68
Romer Compatible Parts.....	69
Adapter Plates and accessories.....	70
Calibration Spheres.....	74
Thread Adapters and accessories.....	75
Unthreaded Styli.....	77
Unthreaded Stylus Holders.....	81
Diamond Styli.....	82
CT Scan Artifacts.....	83
Mitutoyo Compatible Parts.....	83
Design Your Own Standard Stylus.....	84
Design Your Own Miniature Stylus.....	85
Design Your Own Disk Stylus.....	86

M2 Threads

0.2 mm carbide ball with stepped carbide stem

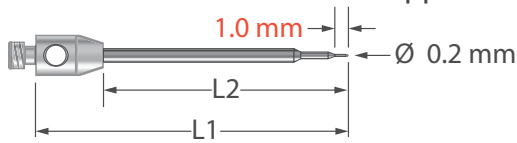

Part Number	L1	L2	Wt	Price
TM2-0210-C	10.0	5.0	0.24	\$190.00
TM2-0215-C	15.0	10.0	0.27	\$190.00
TM2-0218-C	18.0	13.0	0.29	\$190.00
TM2-0220-C	20.0	15.0	0.32	\$190.00

M2 stylus with 0.2 mm diameter carbide ball, stepped carbide stem, and 3.0 mm diameter stainless steel base. Minor stem diameter is 0.17 mm, intermediate diameter is 0.5 mm, and major diameter is 1.0 mm.

0.2 mm ruby ball with tapered carbide stem

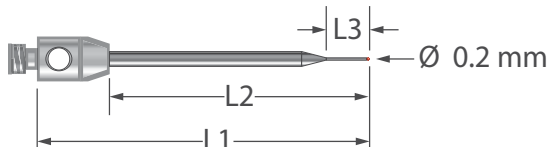

Part Number	L1	L2	L3	Wt	Price
TM2-0210-R	10.0	5.0	2.0	0.21	\$185.00
TM2-0215-R	15.0	10.0	2.0	0.23	\$185.00
TM2-0218-R	18.0	13.0	2.0	0.28	\$185.00
TM2-0220-R	20.0	15.0	2.0	0.30	\$185.00
TM2-0223-R	23.0	15.0	1.3	0.33	\$310.00

M2 stylus with 0.2 mm diameter ruby ball, tapered carbide stem, and 3.0 mm diameter stainless steel base. Minor stem diameter is 0.15 mm* and major diameter is 1.0 mm. *Note: minor stem diameter on TM2-0223-R is 0.10 mm.

0.3 mm carbide ball with stepped carbide stem

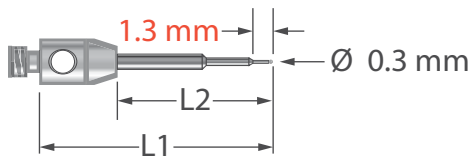

Part Number	L1	L2	Wt	Price
TM2-0310-C	10.0	5.0	0.24	\$126.00
TM2-0313-C	13.0	8.0	0.27	\$132.00
TM2-0315-C	15.0	10.0	0.29	\$132.00
TM2-0318-C	18.0	13.0	0.32	\$132.00
TM2-0319-C	19.0	14.0	0.33	\$132.00
TM2-0320-C	20.0	15.0	0.34	\$135.00

M2 stylus with 0.3 mm diameter carbide ball, stepped carbide stem, and 3.0 mm diameter stainless steel base. Minor stem diameter is 0.2 mm, intermediate diameter is 0.5 mm, and major diameter is 1.0 mm.

0.3 mm ruby ball with tapered carbide stem

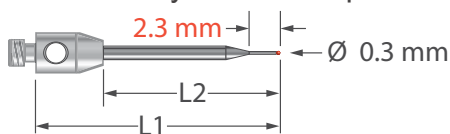

Part Number	L1	L2	Wt	Price
TM2-0310-R	10.0	5.0	0.21	\$110.00
TM2-0318-R	18.0	13.0	0.30	\$121.00
TM2-0320-R	20.0	15.0	0.33	\$135.00
TM2-0323-R	23.0	13.0	0.35	\$135.00

M2 stylus with 0.3 mm diameter ruby ball, tapered carbide stem, and 3.0 mm diameter stainless steel base. Minor stem diameter is 0.2 mm and major diameter is 1.0 mm.

0.4 mm carbide ball with stepped carbide stem

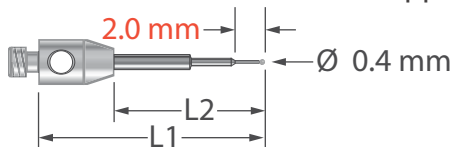

Part Number	L1	L2	Wt	Price
TM2-0410-C	10.0	5.0	0.21	\$120.00
TM2-0415-C	15.0	10.0	0.26	\$125.00
TM2-0418-C	18.0	13.0	0.29	\$125.00

M2 stylus with 0.4 mm diameter carbide ball, stepped carbide stem, and 3.0 mm diameter stainless steel base. Minor stem diameter is 0.25 mm, intermediate diameter is 0.5 mm, major diameter is 1.0 mm.

0.4 mm ruby or silicon nitride ball with tapered carbide stem

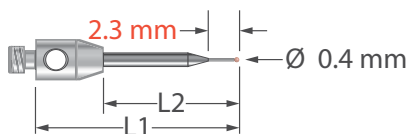

Part Number	L1	L2	Wt	Ruby*	Silicon nitride**
TM2-0410	10.0	5.0	0.21	\$120.00	\$150.00
TM2-0418	18.0	13.0	0.29	\$130.00	\$160.00
TM2-0419	19.0	14.0	0.30	\$130.00	\$160.00

M2 stylus with 0.4 mm diameter ruby ball, tapered carbide stem, and 3.0 mm diameter stainless steel base. Minor stem diameter is 0.3 mm and major diameter is 1.0 mm.

***NOTE: For a ruby ball, add -R to the part number.**

****NOTE: For a silicon nitride ball, add -SN to the part number.**



WARNING: The products on this page can expose you to chemicals including cobalt, nickel, and phenylhydrazine, which are known to the State of California to cause cancer, and bisphenol A (BPA), which is known to the State of California to cause birth defects or other reproductive harm. For more information go to www.p65warnings.ca.gov.

M2 Threads

0.5 mm carbide ball with stepped carbide stem

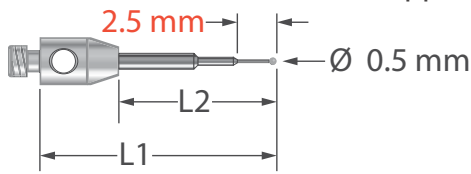

Part Number	L1	L2	Wt	Price
TM2-0510-C	10.0	5.0	0.22	\$110.00
TM2-0513-C	13.0	8.0	0.25	\$103.00
TM2-0515-C	15.0	10.0	0.27	\$103.00
TM2-0518-C	18.0	13.0	0.30	\$103.00
TM2-0520-C	20.0	15.0	0.33	\$103.00

M2 stylus with 0.5 mm diameter carbide ball, stepped carbide stem, and 3.0 mm diameter stainless steel base. Minor stem diameter is 0.3 mm, intermediate diameter is 0.6 mm, major diameter is 1.0 mm.

0.5 mm ruby or silicon nitride ball with tapered carbide stem

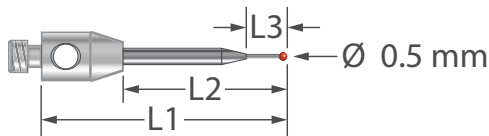

Part Number	L1	L2	L3	Wt	Ruby*	Silicon Nitride**
TM2-0510	10.0	5.0	2.5	0.31	\$89.00	\$119.00
TM2-0510.25	10.25	4.25	3.25	0.31	\$89.00	\$119.00
TM2-0518	18.0	13.0	2.5	0.32	\$115.00	\$145.00
TM2-0519	19.0	14.0	2.5	0.32	\$115.00	\$145.00
TM2-0520	20.0	15.0	2.5	0.33	\$115.00	\$145.00

M2 stylus with 0.5 mm diameter ruby or silicon nitride ball, tapered carbide stem, and 3.0 mm diameter stainless steel base. Minor stem diameter is 0.3 mm*, major diameter is 1.0 mm. *Note: minor stem diameter is 0.4 mm on part number TM2-0510.25.

0.5 mm ball with 0.3 mm carbide stem



Part Number	L	Wt	Ruby*	Silicon Nitride**
TM2-0520-07	20.0	0.30	\$97.00	\$160.00

M2 stylus with 0.5 mm diameter ball, 0.3 mm diameter carbide stem, and 3.0 mm diameter x 13.0 mm long stainless steel base.

0.6 mm carbide ball with stepped carbide stem

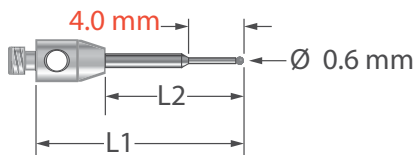

Part Number	L1	L2	Wt	Carbide
TM2-0610-C	10.0	5.0	0.25	\$125.00
TM2-0615-C	15.0	10.0	0.31	\$130.00
TM2-0618-C	18.0	13.0	0.34	\$130.00
TM2-0620-C	20.0	15.0	0.36	\$130.00
TM2-0630-C	30.0	22.0	0.47	\$140.00

M2 stylus with 0.6 mm diameter carbide ball, stepped carbide stem, and 3.0 mm diameter stainless steel base. Minor stem diameter is 0.4 mm, major diameter is 1.0 mm.

0.6 mm ball with stepped carbide stem

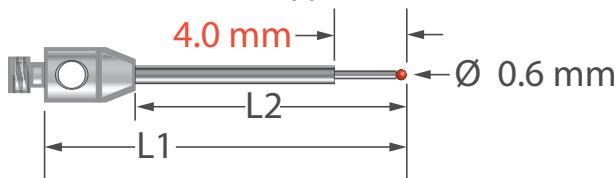

Part Number	L1	L2	Wt	Ruby*	Silicon Nitride**	Zirconia***
TM2-0610	10.0	5.0	0.26	\$88.00	\$118.00	\$118.00
TM2-0615	15.0	10.0	0.31	\$88.00	\$118.00	\$118.00
TM2-0618	18.0	13.0	0.35	\$88.00	\$118.00	\$118.00
TM2-0620	20.0	15.0	0.37	\$88.00	\$118.00	\$118.00

M2 stylus with 0.6 mm diameter ruby ball, stepped carbide stem, and 3.0 mm diameter stainless steel base. Minor stem diameter is 0.4 mm, major diameter is 1.0 mm.

0.7 mm ruby ball with 0.5 mm carbide stem

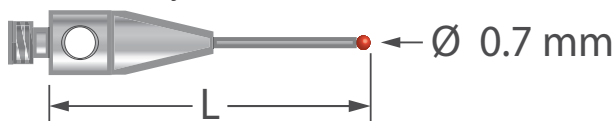

Part Number	L	Wt	Price
TM2-0710	10.0	0.24	\$79.00
TM2-0720.35	20.35	0.30	\$97.00

M2 stylus with 0.7 mm diameter ruby ball, 0.5 mm diameter carbide stem, and 3.0 mm diameter x 8.0 mm long stainless steel base.

***NOTE: For a ruby ball, add -R to the part number.**

****NOTE: For a silicon nitride ball, add -SN to the part number.**

*****NOTE: For a zirconia ball, add -Z to the part number.**



WARNING: The products on this page can expose you to chemicals including cobalt, nickel, and phenylhydrazine, which are known to the State of California to cause cancer, and bisphenol A (BPA), which is known to the State of California to cause birth defects or other reproductive harm. For more information go to www.p65warnings.ca.gov.

M2 Threads

0.8 mm ball with 0.7 mm carbide stem



Part Number	L	Wt	Ruby	Silicon Nitride**	Zirconia***
TM2-0820-DS.7	20.0	0.30	\$80.00	\$110.00	\$110.00
TM2-0825-DS.7	25.0	0.33	\$80.00	\$110.00	\$110.00

M2 stylus with 0.8 mm diameter ruby ball, 0.7 mm diameter carbide stem, and 3.0 mm diameter x 5.0 mm long stainless steel base.

0.8 mm ball with stepped carbide stem

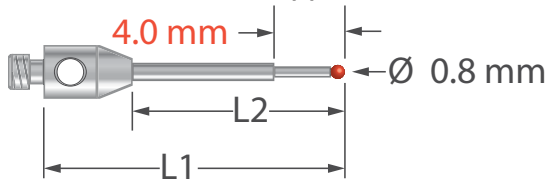

Part Number	L1	L2	Wt	Ruby*	Silicon Nitride**	Zirconia***
TM2-0812	12.0	7.0	0.32	\$68.00	\$98.00	\$98.00
TM2-0815	15.0	10.0	0.34	\$68.00	\$98.00	\$98.00
TM2-0818	18.0	13.0	0.38	\$68.00	\$98.00	\$98.00
TM2-0820	20.0	15.0	0.40	\$68.00	\$98.00	\$98.00
TM2-0830	30.0	22.0	0.55	\$68.00	\$98.00	\$98.00

M2 stylus with 0.8 mm diameter ruby ball, stepped carbide stem, and 3.0 mm diameter stainless steel base. Minor stem diameter is 0.6 mm, major diameter is 1.0 mm.

0.8 mm ball with tapered carbide stem

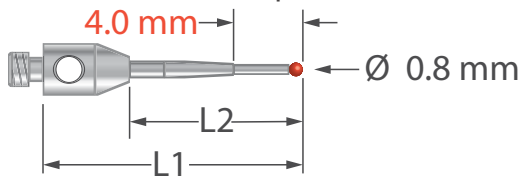

Part Number	L1	L2	Wt	Ruby	Silicon Nitride*	Zirconia**
TM2-0812-T	12.0	7.0	0.32	\$68.00	\$98.00	\$98.00
TM2-0815-T	15.0	10.0	0.35	\$68.00	\$98.00	\$98.00
TM2-0818-T	18.0	13.0	0.38	\$68.00	\$98.00	\$98.00
TM2-0820-T	20.0	15.0	0.40	\$68.00	\$98.00	\$98.00

M2 stylus with 0.8 mm diameter ruby ball, tapered carbide stem, and 3.0 mm diameter stainless steel base. Minor stem diameter is 0.6 mm, major diameter is 1.0 mm.

1.0 mm ball with stepped carbide stem

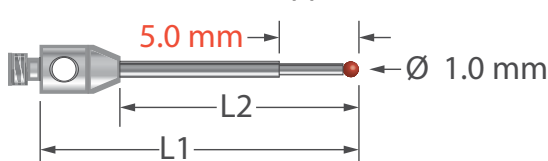

Part Number	L1	L2	Wt	Ruby	Silicon Nitride*	Zirconia**
TM2-1015.5	15.5	10.5	0.32	\$55.00	\$85.00	\$85.00
TM2-1020	20.0	15.0	0.41	\$55.00	\$85.00	\$85.00
TM2-1025	25.0	20.0	0.47	\$55.00	\$85.00	\$85.00
TM2-1027	27.0	19.0	0.49	\$55.00	\$85.00	\$85.00
TM2-1030	30.0	22.0	0.52	\$55.00	\$85.00	\$85.00

M2 stylus with 1.0 mm diameter ruby ball, stepped carbide stem, and 3.0 mm diameter stainless steel base. Minor stem diameter is 0.7 mm, major diameter is 1.0 mm.

1.0 mm ball with tapered carbide stem



Part Number	L1	L2	Wt	Ruby	Silicon Nitride*	Zirconia**
TM2-1041	41.0	33.0	0.89	\$65.00	\$95.00	\$95.00

M2 stylus with 1.0 mm diameter ruby ball, stepped carbide stem, and 3.0 mm diameter stainless steel base. Minor stem diameter is 0.7 mm, major diameter is 1.5 mm.

1.0 mm ball with 0.7 mm carbide stem

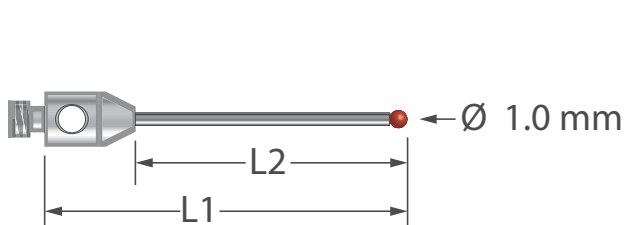

Part Number	L1	L2	Wt	Ruby	Silicon Nitride*	Zirconia**
TM2-1007-DS.7	7.0	2.0	0.25	\$50.00	\$80.00	\$80.00
TM2-1010-DS.7	10.0	5.0	0.26	\$55.00	\$85.00	\$85.00
TM2-1010.5-DS.7	10.5	5.5	0.26	\$69.00	\$68.00	\$99.00
TM2-1015-DS.7	15.0	10.0	0.29	\$55.00	\$85.00	\$85.00
TM2-1020-DS.7	20.0	15.0	0.32	\$55.00	\$85.00	\$85.00
TM2-1020.5-DS.7	20.5	15.5	0.32	\$54.00	\$84.00	\$84.00
TM2-1027.5-DS.7	27.5	20.5	0.40	\$55.00	\$85.00	\$85.00
TM2-1030-DS.7	30.0	22.0	0.42	\$66.00	\$96.00	\$96.00
TM2-1034-DS.7	34.0	26.0	0.47	\$85.00	\$115.00	\$115.00
TM2-1055-DS.7	55.0	47.0	0.59	\$85.00	\$115.00	\$115.00

M2 stylus with 1.0 mm diameter ruby ball, 0.7 mm diameter carbide stem, and 3.0 mm diameter stainless steel base.



WARNING: The products on this page can expose you to chemicals including cobalt, nickel, and phenylhydrazine, which are known to the State of California to cause cancer, and bisphenol A (BPA), which is known to the State of California to cause birth defects or other reproductive harm. For more information go to www.p65warnings.ca.gov.

M2 Threads

1.0 mm ball with 0.8 mm carbide stem

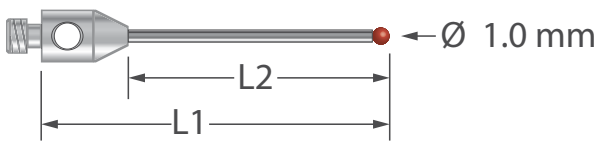

Part Number	L1	L2	Wt	Ruby	Silicon Nitride*	Zirconia**
TM2-1020-DS.8	20.0	15.0	0.42	\$55.00	\$85.00	\$85.00
TM2-1020.5-DS.8	20.5	12.5	0.42	\$50.00	\$85.00	\$85.00
TM2-1030-DS.8	30.0	22.0	0.50	\$55.00	\$85.00	\$85.00
TM2-1030.5-DS.8	30.5	22.5	0.50	\$55.00	\$85.00	\$85.00

M2 stylus with 1.0 mm diameter ruby ball, 0.8 mm diameter carbide stem, and 3.0 mm diameter stainless steel base.

1.35 mm ball with 1.0 mm carbide stem

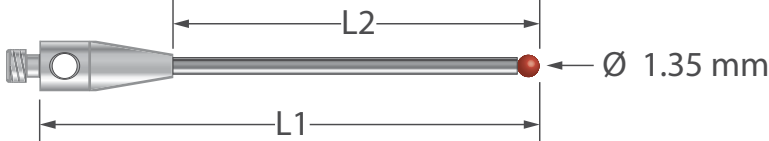

Part Number	L1	L2	Wt	Ruby	Silicon Nitride*
TM2-1315	15.0	10.0	0.38	\$45.00	\$75.00
TM2-1320	20.0	15.0	0.44	\$45.00	\$75.00
TM2-1325	25.0	17.0	0.51	\$45.00	\$75.00
TM2-1330	30.0	22.0	0.57	\$50.00	\$80.00

M2 stylus with 1.35 mm diameter ruby ball, 1.0 mm diameter carbide stem, and 3.0 mm diameter stainless steel base.

1.5 mm ball with 1.0 mm carbide stem

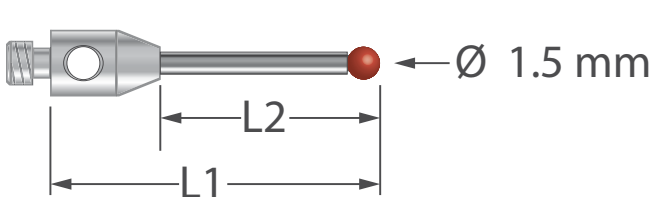

Part Number	L1	L2	Wt	Ruby	Silicon Nitride*	Zirconia**
TM2-1510	10.0	5.0	0.29	\$43.00	\$73.00	\$73.00
TM2-1515	15.0	10.0	0.35	\$43.00	\$73.00	\$73.00
TM2-1520	20.0	15.0	0.40	\$43.00	\$73.00	\$73.00
TM2-1520.75	20.75	13.75	0.41	\$54.00	\$80.00	\$80.00
TM2-1525	25.0	17.0	0.46	\$43.00	\$73.00	\$73.00
TM2-1530.75-DS1	30.75	22.75	0.56	\$37.00	\$73.00	\$80.00
TM2-1535-DS1	35.0	27.0	0.61	\$43.00	\$73.00	\$73.00

M2 stylus with 1.5 mm diameter ball, 1.0 mm diameter carbide stem, and 3.0 mm diameter stainless steel base.

1.5 mm ball with stepped carbide stem

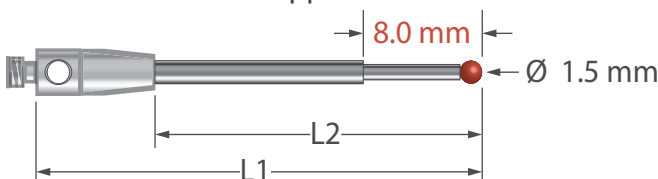

Part Number	L1	L2	Wt	Ruby	Silicon Nitride*	Zirconia**
TM2-1530	30.0	22.0	0.92	\$66.00	\$96.00	\$96.00
TM2-1540	40.0	32.0	1.17	\$66.00	\$96.00	\$96.00

M2 stylus with 1.5 mm diameter ball, stepped carbide stem, and 3.0 mm diameter stainless steel base. Minor stem diameter is 1.0 mm, major diameter is 1.5 mm.

2.0 mm ball with 1.0 mm carbide stem

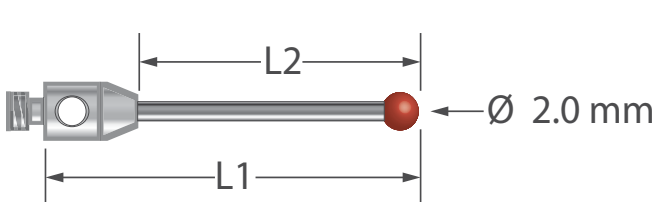

Part Number	L1	L2	Wt	Ruby	Silicon Nitride*	Zirconia**
TM2-2010	10.0	5.0	0.30	\$43.00	\$73.00	\$73.00
TM2-2015	15.0	10.0	0.36	\$43.00	\$73.00	\$73.00
TM2-2020	20.0	15.0	0.42	\$43.00	\$73.00	\$73.00
TM2-2021	21.0	15.0	0.43	\$26.00	\$85.00	\$85.00
TM2-2025	25.0	20.0	0.46	\$43.00	\$73.00	\$73.00
TM2-2031-DS1	31.0	23.0	0.61	\$43.00	\$73.00	\$73.00
TM2-2040-DS1	40.0	32.0	0.70	\$43.00	\$73.00	\$73.00

M2 stylus with 2.0 mm diameter ball, 1.0 mm diameter carbide stem, and 3.0 mm diameter stainless steel base.

2.0 mm ball with 1.5 mm carbide stem

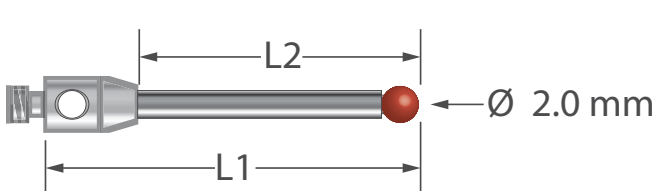

Part Number	L1	L2	Wt	Ruby	Silicon Nitride*	Zirconia**
TM2-2030	30.0	23.0	0.90	\$43.00	\$73.00	\$73.00
TM2-2031	31.0	24.0	0.99	\$43.00	\$73.00	\$73.00
TM2-2035	35.0	28.0	1.04	\$43.00	\$73.00	\$73.00
TM2-2040	40.0	33.0	1.17	\$43.00	\$73.00	\$73.00
TM2-2041	41.0	34.0	1.20	\$44.00	\$74.00	\$74.00
TM2-2050	50.0	43.0	1.42	\$50.00	\$80.00	\$80.00
TM2-2060	60.0	53.0	1.69	\$50.00	\$80.00	\$80.00
TM2-2070	70.0	63.0	1.96	\$55.00	\$85.00	\$85.00

M2 stylus with 2.0 mm diameter ball, 1.5 mm diameter carbide stem, and 3.0 mm diameter stainless steel base.



WARNING: The products on this page can expose you to chemicals including cobalt, nickel, and phenylhydrazine, which are known to the State of California to cause cancer, and bisphenol A (BPA), which is known to the State of California to cause birth defects or other reproductive harm. For more information go to www.p65warnings.ca.gov.

M2 Threads

2.0 mm ball with 1.5 mm carbon fiber stem

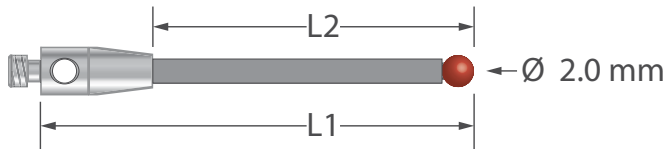

Part Number	L1	L2	Wt	Ruby	Silicon Nitride*	Zirconia**
TM2-2050-G	50.0	43.0	0.39	\$60.00	\$90.00	\$90.00
TM2-2070-G	70.0	63.0	0.44	\$72.00	\$102.00	\$102.00

M2 stylus with 2.0 mm diameter ball, 1.5 mm diameter carbon fiber stem, and 3.0 mm diameter stainless steel base.

2.5 mm ball with 1.0 mm diameter carbide stem

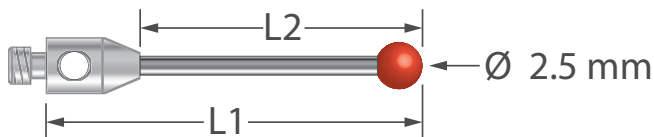

Part Number	L1	L2	Wt	Ruby	Silicon Nitride*	Zirconia**
TM2-2521.25-DS1	21.25	16.25	0.48	\$65.00	\$95.00	\$95.00

M2 stylus with 2.5 mm diameter ball, 1.0 mm diameter carbide stem, and 3.0 mm diameter stainless steel base.

2.5 mm ball with 1.5 mm diameter carbide stem

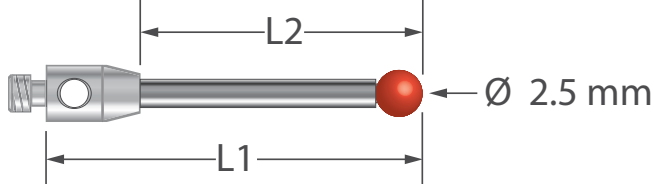

Part Number	L1	L2	Wt	Ruby	Silicon Nitride*	Zirconia**
TM2-2510	10.0	5.0	0.38	\$39.00	\$69.00	\$69.00
TM2-2520	20.0	15.0	0.63	\$39.00	\$69.00	\$69.00
TM2-2530	30.0	23.0	0.88	\$39.00	\$69.00	\$69.00
TM2-2540	40.0	33.0	1.18	\$39.00	\$69.00	\$69.00
TM2-2550	50.0	43.0	1.43	\$44.00	\$74.00	\$74.00

M2 stylus with 2.5 mm diameter ball, 1.5 mm diameter carbide stem, and 3.0 mm diameter stainless steel base.

2.5 mm ball with 2.0 mm diameter carbide stem

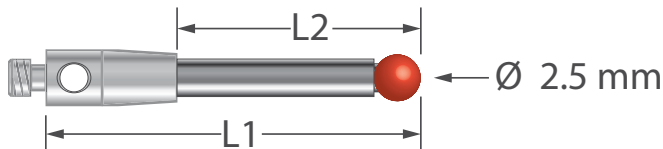

Part Number	L1	L2	Wt	Ruby	Silicon Nitride*	Zirconia**
TM2-2531.25-DS2	31.25	24.25	1.44	\$42.00	\$72.00	\$72.00
TM2-2541.25-DS2	41.25	34.25	1.89	\$45.00	\$75.00	\$75.00

M2 stylus with 2.5 mm diameter ball, 2.0 mm diameter carbide stem, and 3.0 mm diameter stainless steel base.

3.0 mm ball with 1.5 mm carbide stem

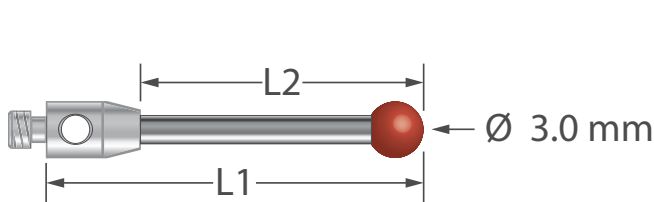

Part Number	L1	L2	Wt	Ruby	Silicon Nitride*	Zirconia**
TM2-3010	10.0	5.0	0.32	\$48.00	\$78.00	\$78.00
TM2-3011.5	11.5	6.5	0.36	\$48.00	\$78.00	\$78.00
TM2-3020	20.0	15.0	0.57	\$48.00	\$78.00	\$78.00
TM2-3021.5	21.5	16.5	0.62	\$48.00	\$78.00	\$78.00
TM2-3024	24.0	19.0	0.67	\$48.00	\$78.00	\$78.00
TM2-3030	30.0	23.0	0.87	\$48.00	\$78.00	\$78.00
TM2-3031.5	31.5	24.5	0.90	\$48.00	\$78.00	\$78.00
TM2-3033	33.0	26.0	0.94	\$48.00	\$78.00	\$78.00

M2 stylus with 3.0 mm diameter ball, 1.5 mm diameter carbide stem, and 3.0 mm diameter stainless steel base.

3.0 mm ball with 2.0 mm carbide stem

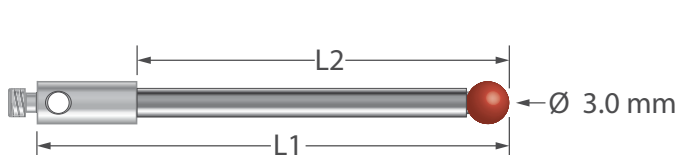

Part Number	L1	L2	Wt	Ruby	Silicon Nitride*	Zirconia**
TM2-3040	40.0	33.0	1.64	\$50.00	\$80.00	\$80.00
TM2-3041.5	41.5	34.5	1.71	\$50.00	\$80.00	\$80.00
TM2-3050	50.0	43.0	2.09	\$50.00	\$80.00	\$80.00
TM2-3051.5	51.5	44.5	2.19	\$43.00	\$72.00	\$72.00
TM2-3063	63.0	56.0	2.67	\$50.00	\$80.00	\$80.00
TM2-3075	75.0	68.0	3.21	\$50.00	\$80.00	\$80.00

M2 stylus with 3.0 mm diameter ball, 2.0 mm diameter carbide stem, and 3.0 mm diameter stainless steel base.

***NOTE: For a silicon nitride ball, add -SN to the part number.**

****NOTE: For a zirconia ball, add -Z to the part number.**



WARNING: The products on this page can expose you to chemicals including cobalt, nickel, and phenylhydrazine, which are known to the State of California to cause cancer, and bisphenol A (BPA), which is known to the State of California to cause birth defects or other reproductive harm. For more information go to www.p65warnings.ca.gov.

M2 Threads

3.0 mm ball with 2.0 mm ceramic stem

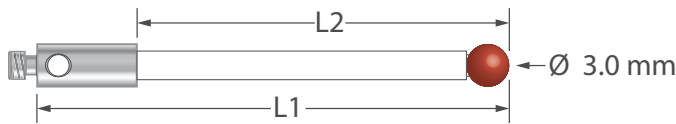

Part Number	L1	L2	Wt	Ruby	Silicon Nitride*	Zirconia**
TM2-3031.5-C	31.5	24.5	0.65	\$70.00	\$100.00	\$100.00
TM2-3050-C	50.0	43.0	0.77	\$61.00	\$91.00	\$91.00
TM2-3051.5-C	51.5	44.5	0.79	\$70.00	\$100.00	\$100.00
TM2-3060-C	60.0	53.0	0.89	\$66.00	\$96.00	\$96.00
TM2-3070-C	70.0	63.0	1.01	\$66.00	\$96.00	\$96.00

M2 stylus with 3.0 mm diameter ball, 2.0 mm diameter ceramic stem, and 3.0 mm diameter stainless steel base.

3.0 mm ball with 2.0 mm carbon fiber stem

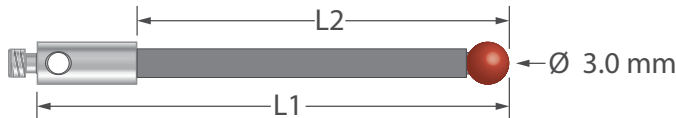

Part Number	L1	L2	Wt	Ruby	Silicon Nitride*	Zirconia**
TM2-3031.5-G	31.5	24.5	0.65	\$59.00	\$89.00	\$89.00
TM2-3040-G	40.0	33.0	0.77	\$61.00	\$91.00	\$91.00
TM2-3041.5-G	41.5	34.5	0.79	\$100.00	\$130.00	\$130.00
TM2-3050-G	50.0	43.0	0.89	\$61.00	\$91.00	\$91.00

M2 stylus with 3.0 mm diameter ball, 2.0 mm diameter carbon fiber stem, and 3.0 mm diameter stainless steel base.

4.0 mm ball with 2.0 mm carbide stem

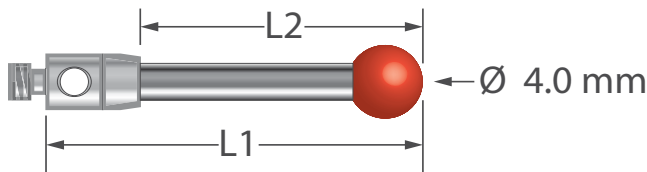

Part Number	L1	L2	Wt	Ruby	Silicon Nitride*	Zirconia**
TM2-4012	12.0	6.0	0.49	\$48.00	\$78.00	\$78.00
TM2-4020	20.0	15.0	0.85	\$48.00	\$78.00	\$78.00
TM2-4022	22.0	17.0	0.94	\$48.00	\$78.00	\$78.00
TM2-4025	25.0	18.0	1.03	\$48.00	\$78.00	\$78.00
TM2-4030	30.0	23.0	1.36	\$48.00	\$78.00	\$78.00
TM2-4032	32.0	25.0	1.45	\$40.00	\$70.00	\$70.00
TM2-4042	42.0	35.0	1.90	\$40.00	\$70.00	\$70.00
TM2-4050	50.0	43.0	2.23	\$50.00	\$80.00	\$80.00
TM2-4052	52.0	45.0	2.32	\$40.00	\$70.00	\$70.00

M2 stylus with 4.0 mm diameter ball, 2.0 mm diameter carbide stem, and 3.0 mm diameter stainless steel base.

4.0 mm ball with 2.0 mm ceramic stem

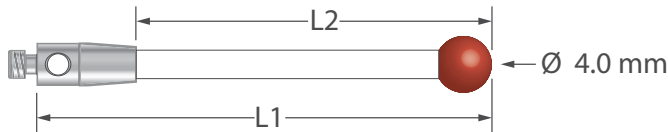

Part Number	L1	L2	Wt	Ruby	Silicon Nitride*	Zirconia**
TM2-4032-C	32.0	25.0	0.65	\$46.00	\$76.00	\$76.00
TM2-4042-C	42.0	35.0	0.74	\$65.00	\$95.00	\$95.00
TM2-4050-C	50.0	43.0	0.84	\$65.00	\$95.00	\$95.00
TM2-4052-C	52.0	45.0	0.86	\$65.00	\$95.00	\$95.00

M2 stylus with 4.0 mm diameter ball, 2.0 mm diameter ceramic stem, and 3.0 mm diameter stainless steel base.

4.0 mm ball with 2.5 mm ceramic stem

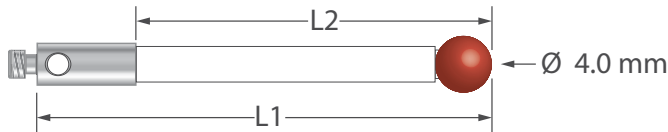

Part Number	L1	L2	Wt	Ruby	Silicon Nitride*	Zirconia**
TM2-4060-C	60.0	53.0	1.26	\$70.00	\$100.00	\$100.00
TM2-4087-C	87.0	80.0	1.77	\$75.00	\$105.00	\$105.00
TM2-4090-C	90.0	83.0	1.83	\$75.00	\$105.00	\$105.00
TM2-40100-C	100.0	93.0	2.03	\$77.00	\$107.00	\$107.00

M2 stylus with 4.0 mm diameter ball, 2.5 mm diameter ceramic stem, and 3.0 mm diameter stainless steel base.

4.0 mm ball with 2.0 mm carbon fiber stem

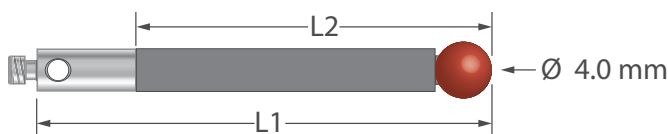

Part Number	L1	L2	Wt	Ruby	Silicon Nitride*	Zirconia**
TM2-4077-G-DS2	77.0	70.0	0.71	\$99.00	\$129.00	\$129.00

M2 stylus with 4.0 mm diameter ball, 2.0 mm diameter carbon fiber stem, and 3.0 mm diameter stainless steel base.

***NOTE: For a silicon nitride ball, add -SN to the part number.**

****NOTE: For a zirconia ball, add -Z to the part number.**

WARNING: The products on this page can expose you to chemicals including cobalt, nickel, and phenylhydrazine, which are known to the State of California to cause cancer, and bisphenol A (BPA), which is known to the State of California to cause birth defects or other reproductive harm. For more information go to www.p65warnings.ca.gov.

M2 Threads

4.0 mm ball with 3.0 mm carbon fiber stem

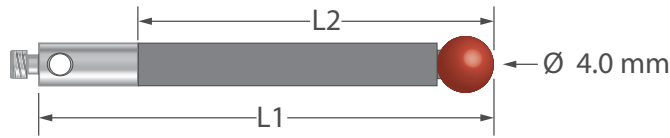

Part Number	L1	L2	Wt	Ruby	Silicon Nitride*	Zirconia**
TM2-4052-G	52.0	45.0	1.17	\$85.00	\$115.00	\$115.00
TM2-4060-G	60.0	53.0	1.26	\$85.00	\$115.00	\$115.00
TM2-4087-G	87.0	80.0	1.77	\$85.00	\$115.00	\$115.00
TM2-4090-G	90.0	83.0	1.83	\$95.00	\$125.00	\$125.00
TM2-40100-G	100.0	93.0	2.03	\$100.00	\$130.00	\$130.00
TM2-40102-G	102.0	95.0	2.05	\$105.00	\$135.00	\$135.00

M2 stylus with 4.0 mm diameter ball, 3.0 mm diameter carbon fiber stem, and 3.0 mm diameter stainless steel base.

5.0 mm ball with 2.5 mm carbide stem

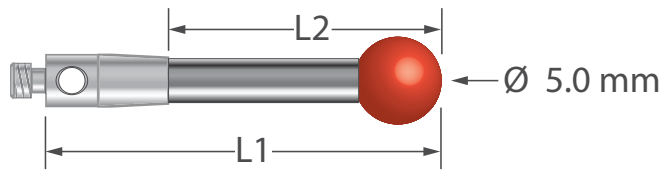

Part Number	L1	L2	Wt	Ruby	Silicon Nitride*	Zirconia**
TM2-5010	10.0	5.0	0.72	\$48.00	\$78.00	\$78.00
TM2-5020	20.0	14.0	1.40	\$48.00	\$78.00	\$78.00
TM2-5022.5	22.5	16.5	1.88	\$43.00	\$80.00	\$80.00
TM2-5030	30.0	24.0	2.08	\$54.00	\$84.00	\$84.00
TM2-5032.5	32.5	26.5	2.45	\$48.00	\$89.00	\$89.00
TM2-5040	40.0	34.0	2.76	\$54.00	\$84.00	\$84.00
TM2-5042.5	42.5	36.5	3.08	\$52.00	\$82.00	\$82.00
TM2-5050	50.0	44.0	3.44	\$58.00	\$88.00	\$88.00
TM2-5052.5	52.5	46.5	3.75	\$52.00	\$82.00	\$82.00

M2 stylus with 5.0 mm diameter ball, 2.5 mm diameter carbide stem, and 3.0 mm diameter stainless steel base.

5.0 mm ball with ceramic stem

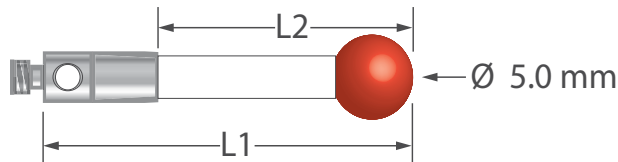

Part Number	L1	L2	Stem Dia	Wt	Ruby	Silicon Nitride*	Zirconia**
TM2-5032.5-C	32.5	26.5	2.5	0.89	\$75.00	\$105.00	\$105.00
TM2-5052.5-C	52.5	46.5	3.0	1.27	\$80.00	\$110.00	\$110.00

M2 stylus with 5.0 mm diameter ball, ceramic stem, and 3.0 mm diameter stainless steel base.

5.0 mm ball with 3.0 mm carbon fiber stem

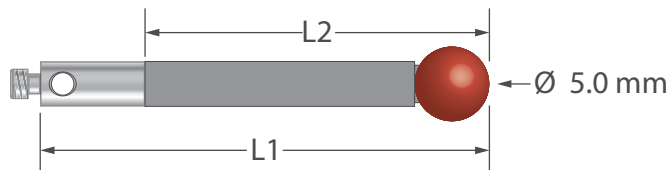

Part Number	L1	L2	Wt	Ruby	Silicon Nitride*	Zirconia**
TM2-5032.5-G	32.5	26.5	0.66	\$89.00	\$110.00	\$110.00
TM2-5050-G	50.0	44.0	0.70	\$63.00	\$93.00	\$93.00
TM2-5052.5-G	52.5	45.5	0.88	\$90.00	\$120.00	\$120.00
TM2-5070-G	70.0	63.0	0.96	\$77.00	\$107.00	\$107.00
TM2-5077.5-G	77.5	70.5	1.22	\$109.00	\$118.00	\$118.00
TM2-5080-G	80.0	73.0	1.26	\$79.00	\$109.00	\$109.00
TM2-50102.5-G	102.5	95.5	1.51	\$120.00	\$150.00	\$150.00

M2 stylus with 5.0 mm diameter ball, 3.0 mm diameter carbon fiber stem, and 3.0 mm diameter stainless steel base.

6.0 mm ball with 2.0 mm carbide stem

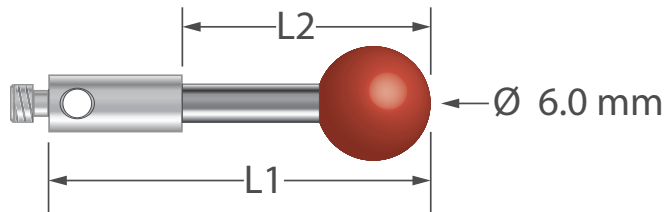

Part Number	L1	L2	Wt	Ruby	Silicon Nitride*	Zirconia**
TM2-6013	13.0	8.0	0.94	\$61.00	\$91.00	\$91.00
TM2-6025	25.0	18.0	1.25	\$72.00	\$102.00	\$102.00
TM2-6030	30.0	23.0	1.47	\$72.00	\$102.00	\$102.00

M2 stylus with 6.0 mm diameter ball, 2.0 mm diameter carbide stem, and 3.0 mm diameter stainless steel base.

***NOTE: For a silicon nitride ball, add -SN to the part number.**

****NOTE: For a zirconia ball, add -Z to the part number.**

WARNING: The products on this page can expose you to chemicals including cobalt, nickel, and phenylhydrazine, which are known to the State of California to cause cancer, and bisphenol A (BPA), which is known to the State of California to cause birth defects or other reproductive harm. For more information go to www.p65warnings.ca.gov.

M2 Threads

6.0 mm ball with 2.5 mm carbide stem

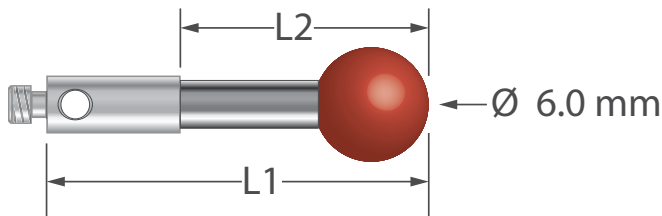

Part Number	L1	L2	Wt	Ruby	Silicon Nitride*	Zirconia**
TM2-6025-DS2.5	25.0	18.0	1.83	\$90.00	\$120.00	\$120.00
TM2-6030-DS2.5	30.0	23.0	2.17	\$90.00	\$120.00	\$120.00
TM2-6050	50.0	43.0	3.53	\$72.00	\$102.00	\$102.00

M2 stylus with 6.0 mm diameter ball, 2.5 mm diameter carbide stem, and 3.0 mm diameter stainless steel base.

6.0 mm ball with 2.5 mm ceramic stem

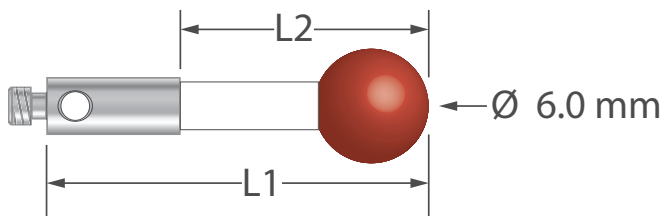

Part Number	L1	L2	Wt	Ruby	Silicon Nitride*	Zirconia**
TM2-6033-C	33.0	26.0	1.10	\$85.00	\$115.00	\$115.00
TM2-6053-C	53.0	46.0	1.35	\$75.00	\$105.00	\$105.00

M2 stylus with 6.0 mm diameter ball, 2.5 mm diameter ceramic stem, and 3.0 mm diameter stainless steel base.

6.0 mm ball with 3.0 mm carbon fiber stem

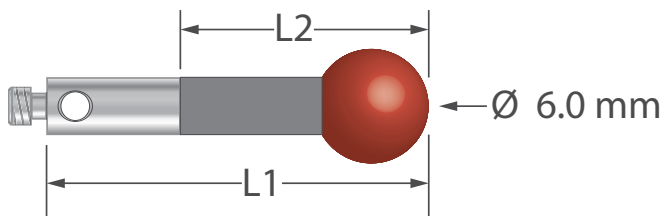

Part Number	L1	L2	Wt	Ruby	Silicon Nitride*	Zirconia**
TM2-6033-G	33.0	26.0	0.87	\$95.00	\$115.00	\$115.00
TM2-6053-G	53.0	46.0	1.08	\$95.00	\$115.00	\$115.00
TM2-6060-G	60.0	53.0	1.16	\$95.00	\$125.00	\$125.00
TM2-6078-G	78.0	71.0	1.36	\$119.00	\$120.00	\$120.00
TM2-60103-G	103.0	96.0	1.63	\$125.00	\$135.00	\$135.00

M2 stylus with 6.0 mm diameter ball, 3.0 mm diameter carbon fiber stem, and 3.0 mm diameter stainless steel base. Stem diameter of part number TM2-6033-G is 2.5 mm.

8.0 mm ball with 3.0 mm carbide stem

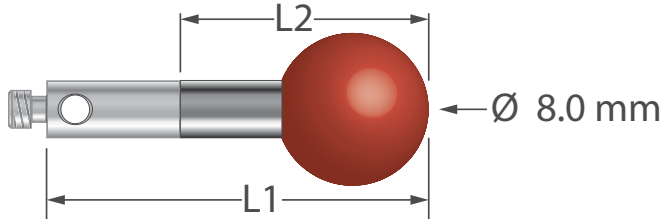

Part Number	L1	L2	Wt	Ruby	Silicon Nitride*	Zirconia**
TM2-8020	20.0	13.0	2.35	\$77.00	\$107.00	\$107.00
TM2-8025	25.0	18.0	2.86	\$80.00	\$110.00	\$110.00

M2 stylus with 8.0 mm diameter ball, 3.0 mm diameter carbide stem, and 3.0 mm diameter stainless steel base.

8.0 mm ball with 3.0 mm carbon fiber stem

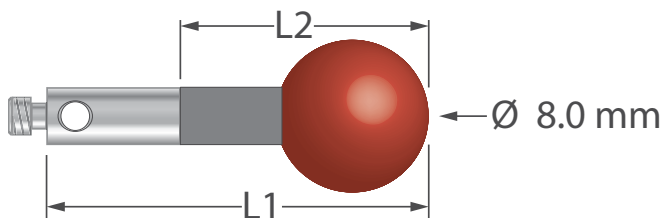

Part Number	L1	L2	Wt	Ruby	Silicon Nitride*	Zirconia**
TM2-8050-G	50.0	43.0	1.56	\$88.00	\$118.00	\$118.00
TM2-8060-G	60.0	53.0	1.67	\$88.00	\$118.00	\$118.00
TM2-80104-G	104.0	97.0	2.15	\$102.00	\$132.00	\$132.00

M2 stylus with 8.0 mm diameter ball, 3.0 mm diameter carbon fiber stem, and 3.0 mm diameter stainless steel base.

***NOTE: For a silicon nitride ball, add -SN to the part number.**

****NOTE: For a zirconia ball, add -Z to the part number.**

WARNING: The products on this page can expose you to chemicals including cobalt, nickel, and phenylhydrazine, which are known to the State of California to cause cancer, and bisphenol A (BPA), which is known to the State of California to cause birth defects or other reproductive harm. For more information go to www.p65warnings.ca.gov.

M2 Threads

M2 extensions, stainless steel

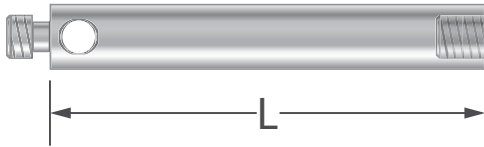

Part Number	L	Wt	Price
VM2-5	5.0	0.20	\$11.00
VM2-7	7.0	0.28	\$11.00
VM2-10	10.0	0.46	\$13.00
VM2-15	15.0	0.73	\$12.00
VM2-20	20.0	1.00	\$13.00
VM2-25	25.0	1.26	\$13.00
VM2-30	30.0	1.53	\$13.00
VM2-35	35.0	1.80	\$15.00
VM2-40	40.0	2.07	\$18.00
VM2-50	50.0	2.60	\$18.00
VM2-60	60.0	3.14	\$21.00
VM2-75	75.0	3.94	\$25.00
VM2-90	90.0	4.74	\$25.00
VM2-100	100.0	5.28	\$30.00
VM2-110	110.0	5.82	\$30.00

M2 extension, 3.0 mm diameter. Stainless steel.

M2 extensions, ceramic and stainless steel

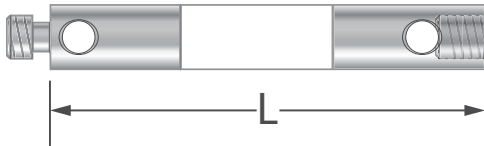

Part Number	L	Wt	Price
VM2-20-C	20.0	0.51	\$55.00
VM2-30-C	30.0	0.71	\$55.00
VM2-40-C	40.0	0.92	\$55.00
VM2-50-C	50.0	1.13	\$58.00
VM2-60-C	60.0	1.35	\$65.00
VM2-80-C	80.0	1.78	\$70.00
VM2-100-C	100.0	2.20	\$70.00

M2 extension, 3.0 mm diameter. Ceramic with stainless steel end fittings.

M2 extensions, carbon fiber and stainless steel

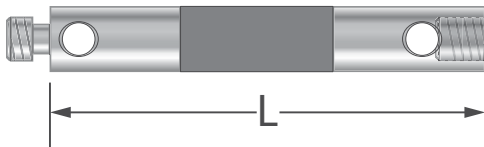

Part Number	L	Wt	Price
VM2-20-G	20.0	0.43	\$70.00
VM2-30-G	30.0	0.49	\$75.00
VM2-40-G	40.0	0.59	\$80.00
VM2-50-G	50.0	0.68	\$80.00
VM2-60-G	60.0	0.86	\$85.00
VM2-70-G	70.0	0.97	\$90.00
VM2-90-G	90.0	1.19	\$95.00
VM2-100-G	100.0	1.30	\$100.00
VM2-140-G	140.0	1.74	\$130.00
VM2-150-G	150.0	1.85	\$135.00

M2 extension, 3.0 mm diameter. Carbon fiber with stainless steel end fittings.

M2 cylinder stylus, stainless steel

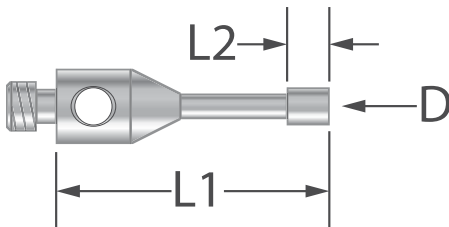

Part Number	D	L1	L2	Wt	Price
TM2-1511-CYL	1.5	11.0	1.5	0.29	\$15.00
TM2-3013-CYL	3.0	13.0	4.0	1.67	\$15.00

M2 stylus with stainless steel cylinder, 1.0 mm diameter stainless steel stem, and 3.0 mm diameter stainless steel base.



WARNING: The products on this page can expose you to chemicals including cobalt, nickel, and phenylhydrazine, which are known to the State of California to cause cancer, and bisphenol A (BPA), which is known to the State of California to cause birth defects or other reproductive harm. For more information go to www.p65warnings.ca.gov.

M2 Threads

Important notes about cylinder styli

Cylinder styli are used for edge probing, for instance, the edges of stampings and thin sheet metal parts. Cylinder styli are not suitable for high accuracy work because the form of a cylinder is not as precise as a sphere. Please contact us with any questions about how to calibrate or use cylinder styli.

M2 cylinder stylus, carbide, with stainless steel base

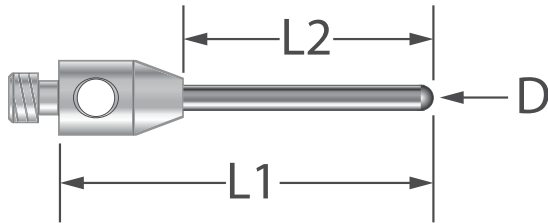

Part Number	D	L1	L2	Wt	Price
TM2-0310-BC	0.3	10.0	3.0	0.28	\$209.00
TM2-0515-BC	0.5	15.0	8.0	0.28	\$180.00
TM2-0520-BC	0.5	20.0	15.0	0.30	\$265.00
TM2-0608-BC	0.6	8.0	3.0	0.25	\$160.00
TM2-0715-BC	0.7	15.0	10.0	0.30	\$110.00
TM2-0720-BC	0.7	20.0	15.0	0.35	\$110.00
TM2-1015-BC	1.0	15.0	10.0	0.34	\$125.00
TM2-1020.5-BC	1.0	20.5	15.5	0.40	\$125.00
TM2-1030-BC	1.0	30.0	23.0	0.57	\$135.00
TM2-1036-BC	1.0	36.0	29.0	0.63	\$140.00
TM2-1515-BC	1.5	15.0	10.0	0.55	\$85.00
TM2-1520-BC	1.5	20.0	15.0	0.86	\$90.00
TM2-2016-BC	2.0	16.0	9.0	0.72	\$79.00
TM2-2040-BC	2.0	40.0	33.0	1.85	\$79.00
TM2-2048-BC	2.0	48.0	41.0	2.21	\$105.00
TM2-3024-BC	3.0	24.0	19.0	1.89	\$135.00

M2 stylus with carbide cylinder and 3.0 mm diameter stainless steel base.

M2 cylinder stylus, ruby, with stainless steel base

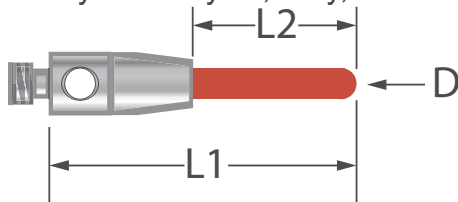

Part Number	D	L1	L2	Wt	Price
TM2-1015-B	1.0	15.0	8.0	0.28	\$143.00
TM2-1515-B	1.5	15.0	8.0	0.28	\$149.00

M2 stylus with ruby cylinder and 3.0 mm diameter stainless steel base.

M2 cylinder stylus, ruby, with stainless steel base and stem

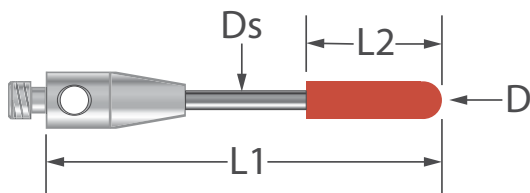

Part Number	D	Ds	L1	L2	Wt	Price
TM2-2021-B	2.0	1.6	21.0	7.2	0.49	\$108.00
TM2-4022-B	4.0	2.0	22.0	10.0	0.93	\$128.00

M2 stylus with ruby cylinder and 3.0 mm diameter stainless steel base.

M2 cylinder stylus, ruby, with stainless steel base and carbide stem

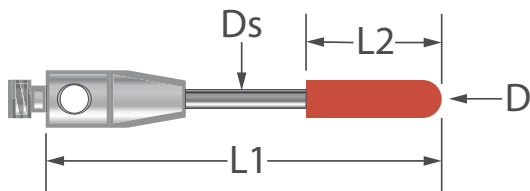

Part Number	D	Ds	L1	L2	Wt	Price
TM2-2025-B	2.0	1.0	25.0	7.2	0.45	\$118.00
TM2-2035-B	2.0	1.0	35.0	7.2	0.56	\$118.00
TM2-2040-B	2.0	1.0	40.0	7.2	0.61	\$123.00
TM2-4020-B	4.0	2.0	20.0	10.0	0.90	\$138.00

M2 stylus with ruby cylinder and 3.0 mm diameter stainless steel base.

WARNING: The products on this page can expose you to chemicals including cobalt, nickel, and phenylhydrazine, which are known to the State of California to cause cancer, and bisphenol A (BPA), which is known to the State of California to cause birth defects or other reproductive harm. For more information go to www.p65warnings.ca.gov.

M2 Threads

M2 stylus with one-piece stainless steel base and stem

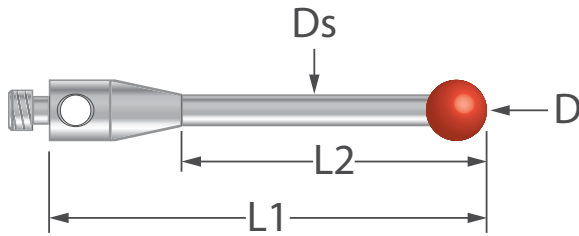

Part Number	D	Ds	L1	L2	Wt	Ruby	Silicon Nitride*
TM2-1010.5-S	1.0	0.7	10.5	4.85	0.22	\$31.00	\$61.00
TM2-1020.5-S	1.0	0.7	20.5	7.5	0.42	\$34.00	\$64.00
TM2-1510.75-S	1.5	0.7	10.75	5.25	0.24	\$21.00	\$51.00
TM2-1520.75-S	1.5	1.0	20.75	8.75	0.44	\$22.00	\$52.00
TM2-2011-S	2.0	1.0	11.0	6.5	0.26	\$21.00	\$54.00
TM2-2021-S	2.0	1.4	21.0	15.0	0.43	\$24.00	\$54.00
TM2-2511.25-S	2.5	1.0	11.25	6.75	0.27	\$21.00	\$51.00
TM2-2521.25-S	2.5	1.4	21.25	15.25	0.47	\$24.00	\$54.00
TM2-3011.5-S	3.0	1.5	11.5	5.0	0.26	\$21.00	\$51.00
TM2-3021.5-S	3.0	1.5	21.5	15.0	0.41	\$24.00	\$54.00
TM2-4012-S	4.0	1.5	12.0	7.0	0.41	\$21.00	\$51.00
TM2-4022-S	4.0	1.5	22.0	16.0	0.70	\$25.00	\$55.00
TM2-5012.5-S	5.0	2.5	12.5	8.5	0.63	\$36.00	\$66.00
TM2-6013-S	6.0	2.5	13.0	9.0	0.72	\$38.00	\$68.00

M2 stylus with 3.0 mm diameter stainless steel base.

M2 cube, stainless steel

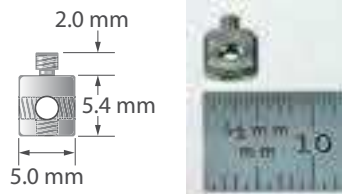

Part Number	Wt	Price
WM2-5	0.71	\$30.00

M2 cube with 5 female threads and 1 male thread.

M2 knuckle joint, 2-way

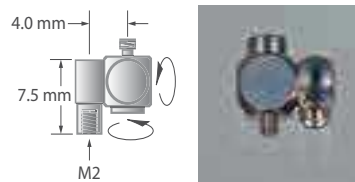

Part Number	Wt	Price
GM2-16	1.66	\$59.00

M2 stylus knuckle, stainless steel, with hex wrench for adjustment.

M2 Stylus Kit



Kit Price

Kit Part Number	Price
OGP-M2KIT	\$600.00

Kit Contents

Part Number	Description	Qty
TM2-3031.5-DS2	3.0 mm ruby stylus	1
TM2-2020	2.0 mm ruby stylus	1
TM2-1020-DS.7	1.0 mm ruby stylus	1
TM2-1515	1.5 mm ruby stylus	1
TM2-0812	0.8 mm ruby stylus	1
GM2-16	Knuckle joint, 2-way	1
KM2-HUB-6	Six-sided star hub	1

Part Number	Description	Qty
TM2-1520-BC	1.5 mm carbide cylinder stylus	1
VM2-20	20.0 mm extension, stainless steel	1
VM2-10	10.0 mm extension, stainless steel	1
VM2-5	5.0 mm extension, stainless steel	1
STR2-2030	Star probe with 2.0 mm ruby styli	1
PK-2	Probe key for M2 products	1

M2 stylus kit consisting of thirteen items and protective case. A \$646.00 value if sold separately.

***NOTE: For a silicon nitride ball, add -SN to the part number.**



WARNING: The products on this page can expose you to chemicals including cobalt, nickel, and phenylhydrazine, which are known to the State of California to cause cancer, and bisphenol A (BPA), which is known to the State of California to cause birth defects or other reproductive harm. For more information go to www.p65warnings.ca.gov.

M2 Threads

M2 pointed stylus, stainless steel, with carbide point

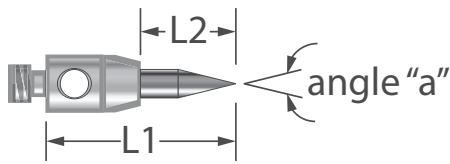

Part Number	"a"	L1	L2	Wt	Price
TM2-S30-C	30.0	10.0	5.0	0.34	\$65.00
TM2-S60-C	60.0	10.0	3.0	0.39	\$65.00
TM2-S90-C	90.0	10.0	3.0	0.40	\$65.00

M2 pointed styli with 3.0 mm diameter stainless steel base and carbide point.

M2 four-way star hub, adjustable

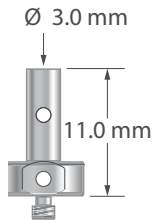

Part Number	Wt	Price
KM2-7-3	1.19	\$63.00

Two-piece M2 star hub with three tapped holes, 120 degrees apart. Fully adjustable. Stainless steel.

M2 five-way star hub, adjustable

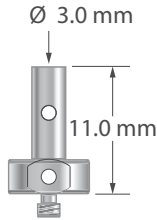

Part Number	Wt	Price
KM2-10	1.13	\$45.00

Two-piece M2 star hub with four tapped holes, 90 degrees apart. Fully adjustable. Stainless steel.

M2 six-sided star hub, adjustable



Part Number	Wt	Price
KM2-HUB-6	0.68	\$65.00

Two-piece M2 six-sided star hub with captive flat head screw for attaching to an M2 extension. All stainless steel. Measures 7.0 mm across opposing flats by 3.0 mm thick. Styli not included.

M2 star probe, adjustable, with threaded hub

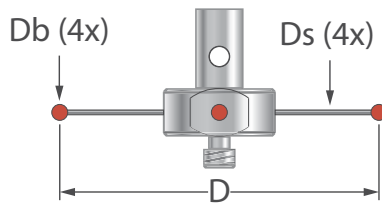

Part Number	Db	Ds	D	Wt	Price
STR2-0510	0.5	0.3	10.0	0.72	\$229.00
STR2-0520	0.5	0.3	20.0	0.75	\$260.00
STR2-1010	1.0	0.7	10.0	0.71	\$137.00
STR2-1020	1.0	0.7	20.0	0.82	\$199.00

Two-piece M2 star probe with ruby balls, carbide stems, and stainless steel fittings.

M2 star probe, adjustable, with center stylus

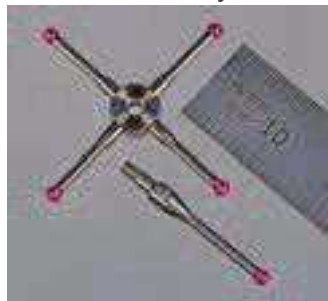
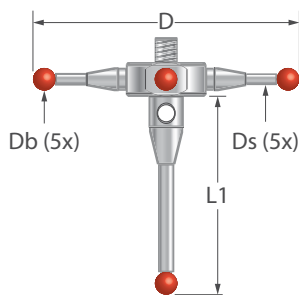

Part Number	Db	Ds	D	L1	Wt	Price
STR2-2020	2.0	1.4	20.0	17.3	1.70	\$138.00
STR2-2030	2.0	1.4	30.0	20.0	1.96	\$132.00

Two-piece M2 star probe with ruby balls and stainless steel bodies. Center hub is stainless steel.



WARNING: The products on this page can expose you to chemicals including cobalt, nickel, and phenylhydrazine, which are known to the State of California to cause cancer, and bisphenol A (BPA), which is known to the State of California to cause birth defects or other reproductive harm. For more information go to www.p65warnings.ca.gov.

M2 Threads

M2 star center stylus with stepped carbide stem

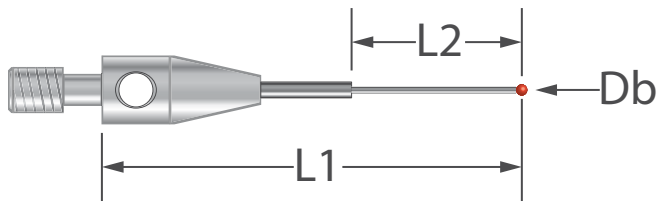

Part Number	Db	L1	L2	Wt	Price
STR2C-0519	0.5	18.5	7.5	0.41	\$149.00

M2 star center stylus with ruby ball, carbide stem, and 3.0 mm diameter stainless steel base. Major stem diameter is 0.7 mm, minor diameter is 0.4 mm.

M2 star center stylus with carbide stem

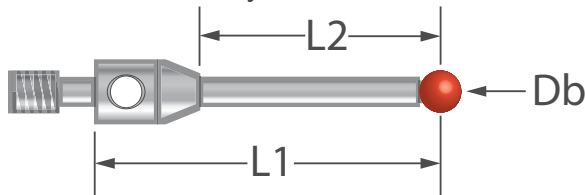

Part Number	Db	L1	L2	Stem Dia.	Stem Mat'l	Wt	Price
STR2C-1009	1.0	8.5	3.5	0.7	Carbide	0.41	\$124.00
STR2C-1019	1.0	18.5	11.5	0.7	Carbide	0.43	\$99.00
STR2C-2017.5	2.0	16.5	11.5	1.4	Stainless steel	0.42	\$65.00

M2 star center stylus with ruby ball and 3.0 mm diameter stainless steel base.

M2 rotary adapter with knurled locking ring

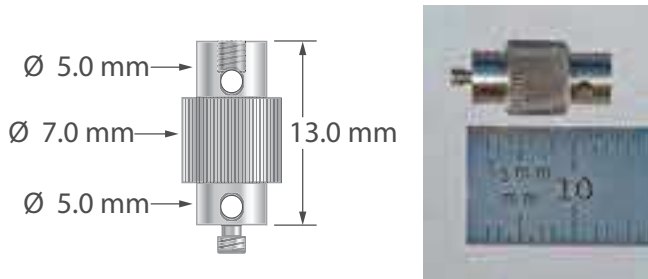

Part Number	Wt	Price
RAP-0513	2.41	\$98.00

M2 rotary adapter allows unlimited axial adjustment of M2 elements, for example, star probes and cubes. Stainless steel.

M2 disk



Part Number	Wt	Price
DSK-M2-180	2.08	\$85.00

M2 disk with 18.0 mm diameter x 3.0 mm thick hard anodized aluminum body, stainless steel threads, and two carbide balls. Weight is 2.08 grams.

M2 thread adapters

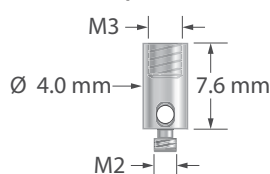

Part Number	Wt	Price
RM2-M3	0.49	\$11.00

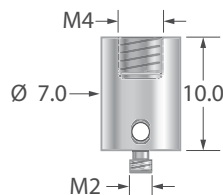

Part Number	Wt	Price
RM2-M4	1.61	\$15.00

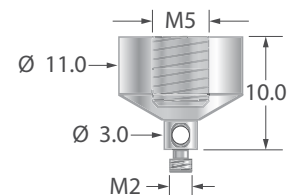

Part Number	Wt	Price
RM2-M5	3.94	\$15.00

M2 thread adapters. Stainless steel.

**NOTE: For a ruby ball, add -R to the part number.*

***NOTE: For a silicon nitride ball, add -SN to the part number.*



WARNING: The products on this page can expose you to chemicals including cobalt, nickel, and phenylhydrazine, which are known to the State of California to cause cancer, and bisphenol A (BPA), which is known to the State of California to cause birth defects or other reproductive harm. For more information go to www.p65warnings.ca.gov.

M3 Threads

0.2 mm carbide ball with stepped carbide stem

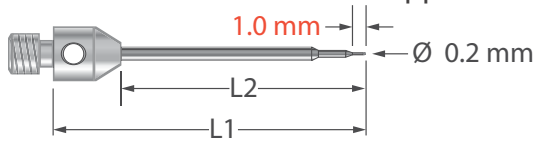

Part Number	L1	L2	Wt	Price
TM3-0220-C	20.0	15.0	0.54	\$195.00

M3 stylus with 0.2 mm diameter carbide ball, stepped carbide stem, and 4.0 mm diameter stainless steel base. Minor stem diameter is 0.17 mm, intermediate diameter is 0.5 mm, and major diameter is 1.0 mm.

0.3 mm carbide ball with stepped carbide stem

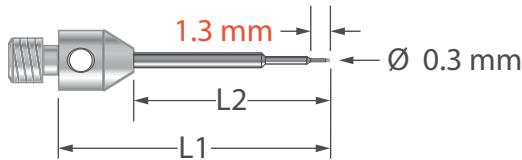

Part Number	L1	L2	Wt	Price
TM3-0310-C	10.0	5.0	0.46	\$135.00
TM3-0315-C	15.0	10.0	0.49	\$135.00
TM3-0318-C	18.0	13.0	0.51	\$135.00
TM3-0319-C	19.0	14.0	0.54	\$135.00
TM3-0320-C	20.0	15.0	0.57	\$135.00

M3 stylus with 0.3 mm diameter carbide ball, stepped carbide stem, and 4.0 mm diameter stainless steel base. Minor stem diameter is 0.2 mm, intermediate diameter is 0.5 mm, and major diameter is 1.0 mm.

0.3 mm ruby ball with tapered carbide stem

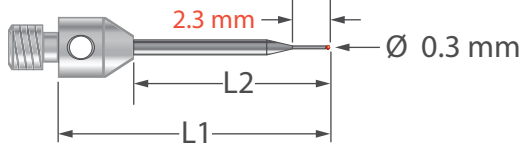

Part Number	L1	L2	Wt	Price
TM3-0318-R	18.0	13.0	0.52	\$135.00
TM3-0322-R	22.0	9.0	0.88	\$132.00

M3 stylus with 0.3 mm diameter ruby ball, tapered carbide stem, and 4.0 mm diameter stainless steel base. Minor stem diameter is 0.2 mm and major diameter is 1.0 mm.

0.4 mm carbide ball with carbide stem

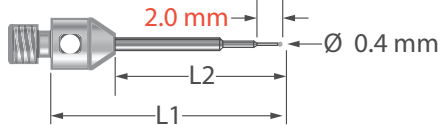

M3 stylus with 0.4 mm diameter ball, stepped carbide stem, and 4.0 mm diameter stainless steel base. Minor stem diameter is 0.25 mm, intermediate is 0.5 mm, and major diameter is 1.0 mm.

Part Number	L1	L2	Wt	Price
TM3-0410-C	10.0	5.0	0.46	\$125.00
TM3-0415-C	15.0	10.0	0.49	\$130.00
TM3-0418-C	18.0	13.0	0.51	\$130.00

0.4 mm ruby or silicon nitride ball with carbide stem

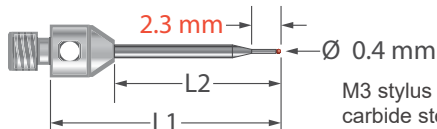

M3 stylus with 0.4 mm diameter ball, tapered carbide stem, and 4.0 mm diameter stainless steel base. Minor stem diameter is 0.3 mm and major diameter is 1.0 mm.

Part Number	L1	L2	Wt	Ruby*	Silicon Nitride**
TM3-0410	10.0	5.0	0.46	\$125.00	\$155.00
TM3-0415	15.0	10.0	0.49	\$125.00	\$155.00
TM3-0418	18.0	13.0	0.51	\$125.00	\$155.00

0.5 mm carbide ball with stepped carbide stem

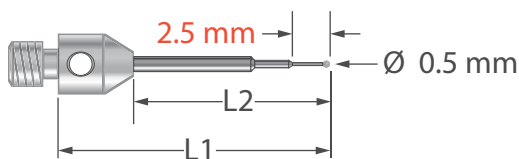

Part Number	L1	L2	Wt	Price
TM3-0510-C	10.0	5.0	0.59	\$108.00
TM3-0515-C	15.0	10.0	0.62	\$108.00
TM3-0518-C	18.0	13.0	0.63	\$108.00
TM3-0519-C	19.0	14.0	0.64	\$108.00
TM3-0520-C	20.0	15.0	0.65	\$108.00

M3 stylus with 0.5 mm diameter carbide ball, stepped carbide stem, and 4.0 mm diameter stainless steel base. Minor stem diameter is 0.3 mm, intermediate diameter is 0.5 mm, and major diameter is 1.0 mm.

0.5 mm ruby or silicon nitride ball with tapered carbide stem and 5.0 mm long base

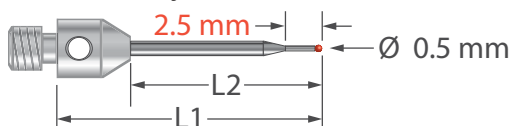

Part Number	L1	L2	Wt	Ruby*	Silicon Nitride**
TM3-0510	10.0	5.0	0.51	\$108.00	\$138.00
TM3-0515	15.0	10.0	0.53	\$108.00	\$138.00
TM3-0518	18.0	13.0	0.54	\$108.00	\$138.00

M3 stylus with 0.5 mm diameter ball, tapered carbide stem, and 4.0 mm diameter stainless steel base. Minor stem diameter is 0.3 mm and major diameter is 1.0 mm.



WARNING: The products on this page can expose you to chemicals including cobalt, nickel, and phenylhydrazine, which are known to the State of California to cause cancer, and bisphenol A (BPA), which is known to the State of California to cause birth defects or other reproductive harm. For more information go to www.p65warnings.ca.gov.

M3 Threads

0.5 mm ruby ball with 0.4 mm carbide stem and 19.0 mm long base

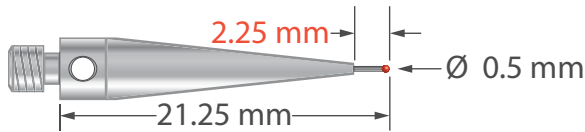

Part Number	Wt	Ruby	Silicon Nitride*	Zirconia**
TM3-0521-02	1.04	\$95.00	\$270.00	\$220.00

M3 stylus with 0.5 mm diameter ruby ball, 0.4 mm diameter carbide stem, and 4.0 mm diameter stainless steel base.

0.5 mm ruby ball with tapered carbide stem and 10.0 mm long base

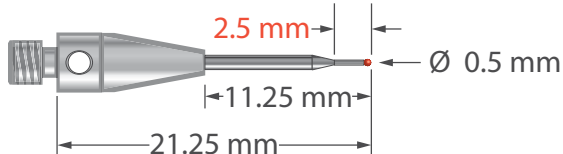

Part Number	Wt	Price
TM3-0521.25	0.89	\$64.00

M3 stylus with 0.5 mm diameter ruby ball, tapered carbide stem, and 4.0 mm diameter stainless steel base. Minor stem diameter is 0.3 mm and major diameter is 1.0 mm.

0.6 mm carbide ball with stepped carbide stem

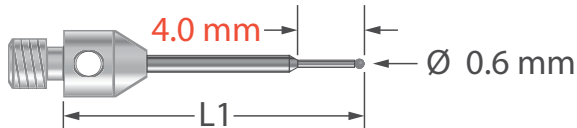

Part Number	L1	Wt	Price
TM3-0610-C	10.0	0.47	\$125.00
TM3-0615-C	15.0	0.50	\$130.00
TM3-0618-C	18.0	0.51	\$130.00
TM3-0620-C	20.0	0.52	\$130.00

M3 stylus with 0.6 mm diameter carbide ball, tapered carbide stem, and 4.0 mm diameter x 5.0 mm long stainless steel base. Minor stem diameter is 0.4 mm and major diameter is 1.0 mm.

0.6 mm ball with stepped carbide stem

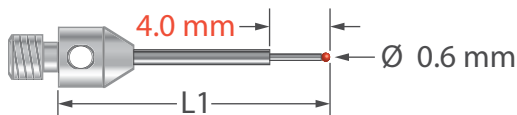

Part Number	L1	Wt	Ruby	Silicon Nitride*
TM3-0610	10.0	0.47	\$94.00	\$124.00
TM3-0615	15.0	0.49	\$94.00	\$124.00
TM3-0618	18.0	0.50	\$94.00	\$124.00
TM3-0620	20.0	0.52	\$94.00	\$124.00

M3 stylus with 0.6 mm diameter ruby or silicon nitride ball, stepped carbide stem, and 4.0 mm diameter x 5.0 mm long stainless steel base. Minor stem diameter is 0.4 mm and major diameter is 1.0 mm.

0.6 mm ball with stepped carbide stem and 13.0 mm long base

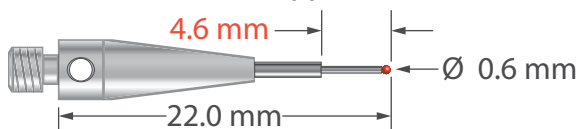

Part Number	Wt	Ruby	Silicon Nitride*
TM3-0622-09	0.90	\$51.00	\$81.00

M3 stylus with 0.6 mm diameter ruby or silicon nitride ball, stepped carbide stem, and 4.0 mm diameter x 13.0 mm long stainless steel base. Minor stem diameter is 0.4 mm and major diameter is 1.0 mm.

0.7 mm ruby ball with 0.5 mm carbide stem and 17.0 mm long base

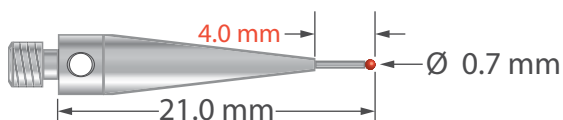

Part Number	L1	Wt	Price
TM3-0721-04	21.0	0.95	\$107.00

M3 stylus with 0.7 mm diameter ruby ball, 0.5 mm diameter carbide stem, and 4.0 mm diameter x 17.0 mm long stainless steel base.

0.8 mm ball with stepped carbide stem and 5.0 mm long base

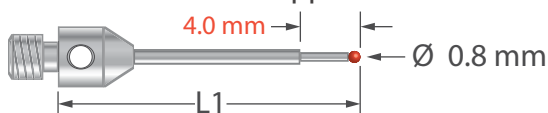

Part Number	L1	Wt	Ruby	Silicon Nitride*
TM3-0812	12.0	0.53	\$74.00	\$104.00
TM3-0815	15.0	0.60	\$74.00	\$104.00
TM3-0820	20.0	0.71	\$74.00	\$104.00
TM3-0830	30.0	0.84	\$80.00	\$110.00

M3 stylus with 0.8 mm diameter ruby ball, stepped carbide stem, and 4.0 mm diameter x 5.0 mm long stainless steel base. Minor stem diameter is 0.6 mm and major diameter is 1.0 mm.



WARNING: The products on this page can expose you to chemicals including cobalt, nickel, and phenylhydrazine, which are known to the State of California to cause cancer, and bisphenol A (BPA), which is known to the State of California to cause birth defects or other reproductive harm. For more information go to www.p65warnings.ca.gov.

M3 Threads

0.8 mm ball with tapered carbide stem and 5.0 mm long base

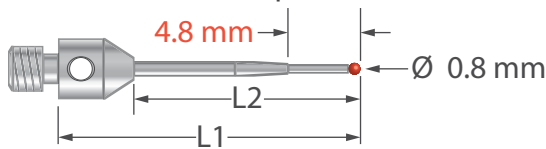

M3 stylus with 0.8 mm diameter ruby ball, tapered carbide stem, and 4.0 mm diameter stainless steel base. Minor stem diameter is 0.6 mm and major diameter is 1.0 mm.

Part Number	L1	L2	Wt	Ruby	Silicon Nitride*
TM3-0812-T	12.0	7.0	0.53	\$74.00	\$104.00
TM3-0815-T	15.0	10.0	0.60	\$74.00	\$104.00
TM3-0820-T	20.0	15.0	0.71	\$74.00	\$104.00
TM3-0830-T	30.0	22.0	0.84	\$80.00	\$110.00

0.8 mm ball with tapered carbide stem and 13.0 mm long base

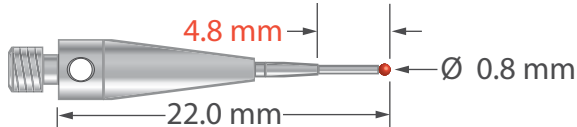

M3 stylus with 0.8 mm diameter ruby ball, tapered carbide stem, and 4.0 mm diameter x 13.0 mm long stainless steel base. Minor stem diameter is 0.4 mm and major diameter is 1.0 mm.

Part Number	Wt	Ruby	Silicon Nitride*
TM3-0822	0.91	\$37.00	\$67.00

1.0 mm ball with 0.7 mm carbide stem

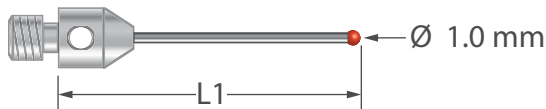

M3 stylus with 1.0 mm diameter ball, 0.7 mm diameter carbide stem, and 4.0 mm diameter x 5.0 mm long stainless steel base.

Part Number	L1	Wt	Ruby	Silicon Nitride*	Zirconia**
TM3-1010-DS.7	10.0	0.46	\$50.00	\$80.00	\$80.00
TM3-1015-DS.7	15.0	0.49	\$50.00	\$80.00	\$80.00
TM3-1020-DS.7	20.0	0.51	\$50.00	\$80.00	\$80.00

1.0 mm ball with stepped carbide stem

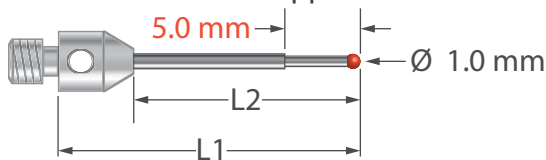

M3 stylus with 1.0 mm diameter ball, stepped carbide stem, and 4.0 mm diameter stainless steel base. Minor stem diameter is 0.7 mm, major diameter is 1.0 mm.

Part Number	L1	L2	Wt	Ruby	Silicon Nitride*	Zirconia**
TM3-1015	15.0	10.0	0.60	\$50.00	\$80.00	\$80.00
TM3-1020	20.0	15.0	0.66	\$50.00	\$80.00	\$80.00
TM3-1022	22.0	17.0	0.69	\$50.00	\$80.00	\$80.00
TM3-1022-13	22.0	9.0	0.95	\$50.00	\$80.00	\$80.00
TM3-1025	25.0	17.0	0.74	\$50.00	\$80.00	\$80.00
TM3-1030	30.0	22.0	0.86	\$55.00	\$85.00	\$85.00

1.0 mm ball with 1.5 mm diameter tapered carbide stem



M3 stylus with 1.0 mm ball, tapered carbide stem, and 4.0 mm diameter x 7.0 mm long stainless steel base. Minor stem diameter is 0.7 mm.

Part Number	L1	L2	Wt	Ruby	Silicon Nitride*	Zirconia**
TM3-1040	40.0	33.0	0.98	\$60.00	\$90.00	\$90.00

1.5 mm ball with 1.0 mm carbide stem

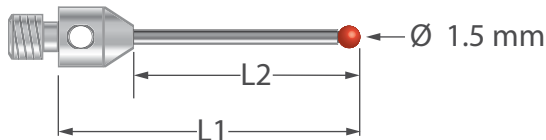

M3 stylus with 1.5 mm diameter ball, 1.0 mm diameter carbide stem, and 4.0 mm diameter stainless steel base.

Part Number	L1	L2	Wt	Ruby	Silicon Nitride*	Zirconia**
TM3-1510	10.0	5.0	0.52	\$60.00	\$90.00	\$90.00
TM3-1520	20.0	15.0	0.60	\$60.00	\$90.00	\$90.00
TM3-1520.75	20.75	13.75	0.77	\$43.00	\$73.00	\$73.00
TM3-1522-09	22.0	9.0	0.57	\$31.00	\$61.00	\$61.00
TM3-1530-DS1	30.0	23.0	0.90	\$60.00	\$90.00	\$90.00
TM3-1530.75-DS1	30.75	23.25	0.90	\$48.00	\$78.00	\$78.00

1.5 mm ball with stepped carbide stem

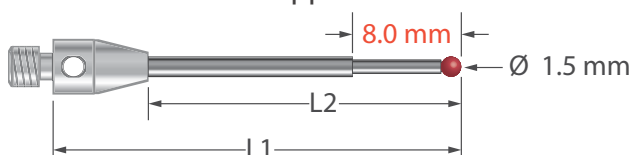

M3 stylus with 1.5 mm diameter ball, stepped carbide stem, and 4.0 mm diameter stainless steel base. Minor stem diameter is 1.0 mm, major diameter is 1.5 mm.

Part Number	L1	L2	Wt	Ruby	Silicon Nitride*	Zirconia**
TM3-1530	30.0	22.0	0.90	\$50.00	\$80.00	\$80.00



WARNING: The products on this page can expose you to chemicals including cobalt, nickel, and phenylhydrazine, which are known to the State of California to cause cancer, and bisphenol A (BPA), which is known to the State of California to cause birth defects or other reproductive harm. For more information go to www.p65warnings.ca.gov.

M3 Threads

2.0 mm ball with carbide stem

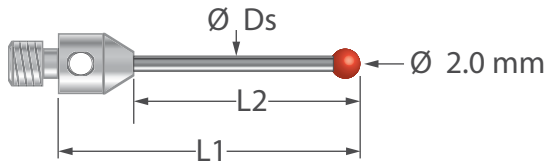

M3 stylus with 2.0 mm diameter ball, carbide stem, and 4.0 mm diameter stainless steel base.

Part Number	L1	L2	Ds	Wt	Ruby	Silicon Nitride*	Zirconia**
TM3-2010	10.0	5.0	1.0	0.52	\$45.00	\$75.00	\$75.00
TM3-2011	11.0	6.0	1.0	0.52	\$45.00	\$75.00	\$75.00
TM3-2015	15.0	10.0	1.0	0.56	\$45.00	\$75.00	\$75.00
TM3-2019	19.0	14.0	1.0	0.60	\$45.00	\$75.00	\$75.00
TM3-2020	20.0	15.0	1.0	0.61	\$45.00	\$75.00	\$75.00
TM3-2021	21.0	16.0	1.0	0.63	\$45.00	\$75.00	\$75.00
TM3-2021-6	21.0	15.0	1.0	0.70	\$31.00	\$61.00	\$61.00
TM3-2025	25.0	18.0	1.0	0.79	\$45.00	\$75.00	\$75.00
TM3-2030	30.0	23.0	1.5	0.98	\$43.00	\$73.00	\$73.00
TM3-2031	31.0	24.0	1.5	1.26	\$45.00	\$75.00	\$75.00
TM3-2035	35.0	28.0	1.5	1.29	\$45.00	\$75.00	\$75.00
TM3-2040	40.0	33.0	1.5	1.48	\$48.00	\$78.00	\$78.00
TM3-2041	41.0	34.0	1.5	1.50	\$45.00	\$75.00	\$75.00
TM3-2050	50.0	43.0	1.5	1.73	\$48.00	\$78.00	\$78.00
TM3-2051	51.0	44.0	1.5	1.75	\$48.00	\$78.00	\$78.00
TM3-2070	70.0	63.0	1.5	2.23	\$55.00	\$85.00	\$85.00
TM3-20100	100.0	93.0	1.5	2.97	\$65.00	\$95.00	\$95.00

2.5 mm ball with 1.5 mm diameter carbide stem

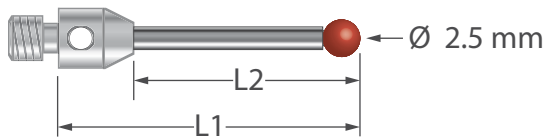

M3 stylus with 2.5 mm diameter ball, 1.5 mm diameter carbide stem, and 4.0 mm diameter stainless steel base.

Part Number	L1	L2	Wt	Ruby	Silicon Nitride*	Zirconia**
TM3-2520	20.0	15.0	1.05	\$42.00	\$72.00	\$72.00
TM3-2530	30.0	23.0	1.19	\$43.00	\$73.00	\$73.00
TM3-2531.25	31.25	24.25	1.28	\$43.00	\$73.00	\$73.00
TM3-2540	40.0	33.0	1.46	\$48.00	\$78.00	\$78.00
TM3-2541.25	41.25	34.25	1.53	\$48.00	\$78.00	\$78.00
TM3-2550	50.0	43.0	1.73	\$50.00	\$80.00	\$80.00
TM3-2572	72.0	65.0	2.32	\$60.00	\$90.00	\$90.00

2.5 mm ball with 2.0 mm diameter carbide stem

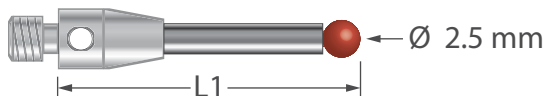

M3 stylus with 2.5 mm diameter ball, 2.0 mm diameter carbide stem, and 4.0 mm diameter x 7.0 mm long stainless steel base.

Part Number	L1	Wt	Ruby	Silicon Nitride*	Zirconia**
TM3-2531.25-DS2	31.25	1.77	\$43.00	\$73.00	\$73.00
TM3-2541.25-DS2	41.25	2.21	\$48.00	\$78.00	\$78.00

3.0 mm ball with carbide stem

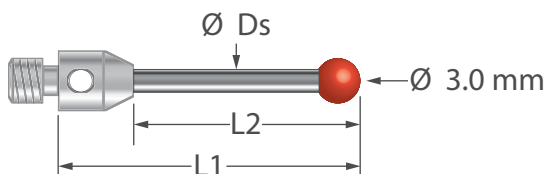

M3 stylus with 3.0 mm diameter ball, carbide stem, and 4.0 mm diameter stainless steel base.

Part Number	L1	L2	Ds	Wt	Ruby	Silicon Nitride*	Zirconia**
TM3-3015	15.0	10.0	1.5	0.85	\$44.00	\$74.00	\$74.00
TM3-3020	20.0	15.0	1.5	0.99	\$44.00	\$74.00	\$74.00
TM3-3021-8	21.0	13.0	2.0	1.16	\$34.00	\$64.00	\$64.00
TM3-3021.5	21.5	15.5	1.5	0.80	\$48.00	\$78.00	\$78.00
TM3-3025	25.0	18.0	1.5	1.13	\$45.00	\$75.00	\$75.00
TM3-3030	30.0	23.0	2.0	1.42	\$45.00	\$75.00	\$75.00
TM3-3031.5-DS1.5	31.5	24.5	1.5	1.31	\$39.00	\$69.00	\$69.00
TM3-3031.5-DS2	31.5	24.5	2.0	1.76	\$43.00	\$73.00	\$73.00
TM3-3035	35.0	28.0	2.0	1.40	\$45.00	\$75.00	\$75.00
TM3-3040-DS1.5	40.0	33.0	1.5	1.54	\$48.00	\$78.00	\$78.00
TM3-3040	40.0	33.0	2.0	2.02	\$48.00	\$78.00	\$78.00
TM3-3041.5-DS1.5	41.5	34.5	1.5	1.58	\$48.00	\$78.00	\$78.00
TM3-3041.5	41.5	34.5	2.0	2.26	\$48.00	\$78.00	\$78.00

*NOTE: For a silicon nitride ball, add -SN to the part number.

**NOTE: For a zirconia ball, add -Z to the part number.



WARNING: The products on this page can expose you to chemicals including cobalt, nickel, and phenylhydrazine, which are known to the State of California to cause cancer, and bisphenol A (BPA), which is known to the State of California to cause birth defects or other reproductive harm. For more information go to www.p65warnings.ca.gov.

M3 Threads

3.0 mm ball with 2.0 mm carbide stem

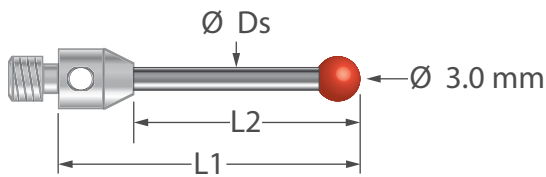

Part Number	L1	L2	Ds	Wt	Ruby	Silicon Nitride*	Zirconia**
TM3-3050	50.0	43.0	2.0	2.58	\$52.00	\$82.00	\$82.00
TM3-3051.5	51.5	44.5	2.0	2.65	\$49.00	\$79.00	\$79.00
TM3-3058	58.0	51.0	2.0	2.93	\$52.00	\$82.00	\$82.00
TM3-3060	60.0	53.0	2.0	3.02	\$54.00	\$84.00	\$84.00
TM3-3070	70.0	63.0	2.0	3.46	\$56.00	\$86.00	\$86.00
TM3-3085	85.0	78.0	2.0	4.12	\$56.00	\$86.00	\$86.00
TM3-30100	100.0	93.0	2.0	4.79	\$74.00	\$104.00	\$104.00

M3 stylus with 3.0 mm diameter ball, 2.0 mm diameter carbide stem, and 4.0 mm diameter stainless steel base.

3.0 mm ball with 2.0 mm ceramic stem

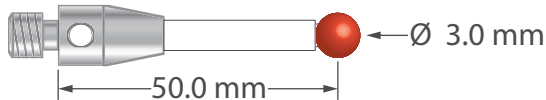

Part Number	Wt	Ruby	Silicon Nitride*	Zirconia**
TM3-3051.5-C	1.34	\$62.00	\$92.00	\$92.00

M3 stylus with 3.0 mm diameter ball, 2.0 mm diameter ceramic stem, and 4.0 mm diameter x 7.0 mm long stainless steel base.

4.0 mm ball with carbide stem

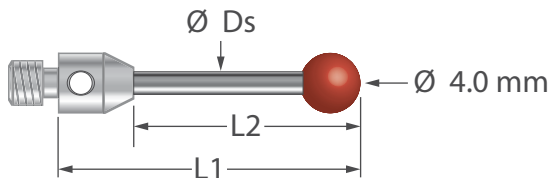

Part Number	L1	L2	Ds	Wt	Ruby	Silicon Nitride*	Zirconia**
TM3-4020	20.0	15.0	2.0	1.25	\$47.00	\$77.00	\$77.00
TM3-4025	25.0	18.0	2.0	1.48	\$47.00	\$77.00	\$77.00
TM3-4030	30.0	23.0	2.0	1.71	\$42.00	\$72.00	\$72.00
TM3-4040	40.0	33.0	2.0	1.94	\$52.00	\$82.00	\$82.00
TM3-4042	42.0	35.0	2.0	2.03	\$43.00	\$73.00	\$73.00
TM3-4050	50.0	43.0	2.0	2.58	\$52.00	\$82.00	\$82.00
TM3-4052	52.0	45.0	2.0	2.67	\$52.00	\$82.00	\$82.00
TM3-4070	70.0	63.0	2.5	5.02	\$62.00	\$92.00	\$92.00
TM3-40100	100.0	93.0	2.5	7.08	\$65.00	\$95.00	\$95.00

M3 stylus with 4.0 mm diameter ball, carbide stem, and 4.0 mm diameter stainless steel base.

4.0 mm ball with ceramic stem

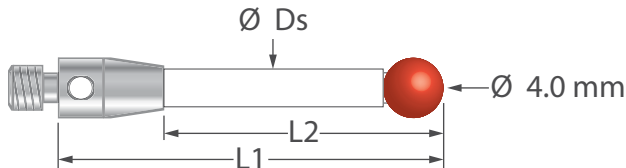

Part Number	L1	L2	Ds	Wt	Ruby	Silicon Nitride*	Zirconia**
TM3-4032-C	32.0	25.0	2.0	0.73	\$40.00	\$70.00	\$70.00
TM3-4052-C	52.0	45.0	2.0	1.05	\$65.00	\$95.00	\$95.00
TM3-40100-C	100.0	93.0	2.5	2.31	\$75.00	\$105.00	\$105.00
TM3-40120-C	120.0	110.0	2.5	2.68	\$80.00	\$110.00	\$110.00

M3 stylus with 4.0 mm diameter ball, ceramic stem, and 4.0 mm diameter x 7.0 mm long stainless steel base.

5.0 mm ball with 2.5 mm carbide stem

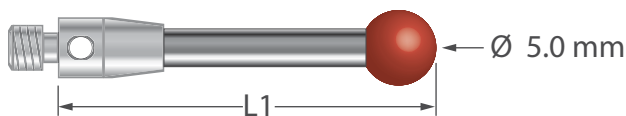

Part Number	L1	Wt	Ruby	Silicon Nitride*	Zirconia**
TM3-5020	20.0	1.70	\$55.00	\$85.00	\$85.00
TM3-5030	30.0	2.38	\$55.00	\$85.00	\$85.00
TM3-5040	40.0	2.72	\$57.00	\$87.00	\$87.00
TM3-5042.5	42.5	2.86	\$65.00	\$95.00	\$95.00
TM3-5050	50.0	3.40	\$58.00	\$88.00	\$88.00
TM3-5052.5	52.5	3.54	\$52.00	\$82.00	\$82.00
TM3-5070	70.0	4.77	\$76.00	\$106.00	\$106.00
TM3-50100	100.0	6.82	\$76.00	\$106.00	\$106.00

M3 stylus with 5.0 mm diameter ball, 2.5 mm diameter carbide stem, and 4.0 mm diameter x 7.0 mm long stainless steel base.

5.0 mm ball with 2.5 mm ceramic stem

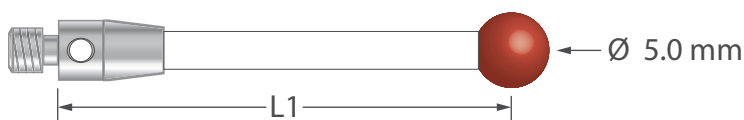

Part Number	L1	Wt	Ruby	Silicon Nitride*	Zirconia**
TM3-5032.5-C	30.0	1.15	\$75.00	\$105.00	\$105.00
TM3-5050-C	47.5	1.41	\$68.00	\$98.00	\$98.00
TM3-5052.5-C	50.0	1.45	\$65.00	\$95.00	\$95.00

M3 stylus with 5.0 mm diameter ball, 2.5 mm diameter ceramic stem, and 4.0 mm diameter x 7.0 mm long stainless steel base.



WARNING: The products on this page can expose you to chemicals including cobalt, nickel, and phenylhydrazine, which are known to the State of California to cause cancer, and bisphenol A (BPA), which is known to the State of California to cause birth defects or other reproductive harm. For more information go to www.p65warnings.ca.gov.

M3 Threads

5.0 mm ball with 2.5 mm carbon fiber stem



Part Number	L1	Wt	Ruby	Silicon Nitride*	Zirconia**
TM3-5025-G	25.0	0.78	\$65.00	\$95.00	\$95.00
TM3-5040-G	40.0	0.90	\$67.00	\$97.00	\$97.00
TM3-5050-G	50.0	0.97	\$68.00	\$98.00	\$98.00

M3 stylus with 5.0 mm diameter ball, 2.5 mm diameter carbon fiber stem, and 4.0 mm diameter x 7.0 mm long stainless steel base.

6.0 mm ball with 2.5 mm carbide stem

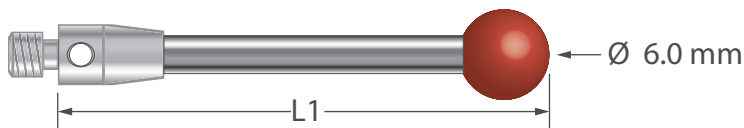

Part Number	L1	Wt	Ruby	Silicon Nitride*	Zirconia**
TM3-6020	20.0	1.55	\$59.00	\$89.00	\$89.00
TM3-6050	50.0	3.60	\$66.00	\$96.00	\$96.00
TM3-6060	60.0	4.29	\$66.00	\$96.00	\$96.00

M3 stylus with 6.0 mm diameter ball, 2.5 mm diameter carbide stem, and 4.0 mm diameter x 7.0 mm long stainless steel base.

6.0 mm ball with 2.0 mm ceramic stem

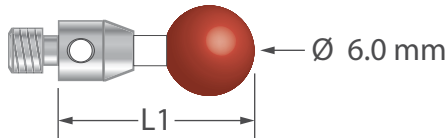

Part Number	L1	Wt	Ruby	Silicon Nitride*	Zirconia**
TM3-6013-C	13.0	0.90	\$75.00	\$105.00	\$105.00

M3 stylus with 6.0 mm diameter ball, 2.0 mm diameter ceramic stem, and 4.0 mm diameter x 5.0 mm long stainless steel base.

6.0 mm ball with ceramic stem

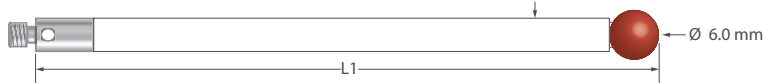

Part Number	L1	Ds	Wt	Ruby	Silicon Nitride*	Zirconia**
TM3-6075-C	75.0	3.5	3.83	\$78.00	\$108.00	\$108.00
TM3-60100-C	100.0	4.0	4.98	\$90.00	\$120.00	\$120.00

M3 stylus with 6.0 mm diameter ball, ceramic stem, and 4.0 mm diameter x 7.0 mm long stainless steel base.

6.0 mm ball with 4.0 mm carbon fiber stem



Part Number	L1	Wt	Ruby	Silicon Nitride*	Zirconia**
TM3-6078-G	78.0	2.09	\$120.00	\$150.00	\$150.00
TM3-60103-G	103.0	2.57	\$130.00	\$145.00	\$160.00

M3 stylus with 6.0 mm diameter ball, 4.0 mm diameter carbon fiber stem, and 4.0 mm diameter x 7.0 mm long stainless steel base.

7.0 mm ball with 3.0 mm carbide stem

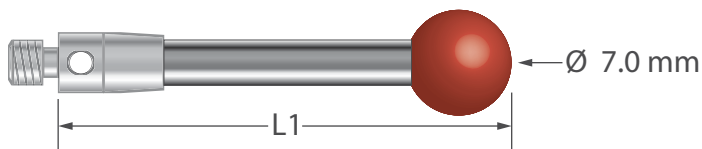

Part Number	L1	Wt	Ruby	Silicon Nitride*	Zirconia**
TM3-7030	30.0	3.22	\$85.00	\$115.00	\$115.00
TM3-7050	50.0	5.24	\$90.00	\$120.00	\$120.00

M3 stylus with 7.0 mm diameter ball, 3.0 mm diameter carbide stem, and 4.0 mm diameter x 7.0 mm long stainless steel base.

7.0 mm ball with carbon fiber stem

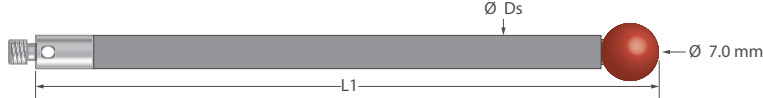

Part Number	L1	Ds	Wt	Ruby	Silicon Nitride*	Zirconia**
TM3-7075-G	75.0	3.5	2.17	\$140.00	\$170.00	\$170.00
TM3-70150-G	150.0	4.0	3.29	\$165.00	\$195.00	\$195.00

M3 stylus with 7.0 mm diameter ball, carbon fiber stem, and 4.0 mm diameter x 7.0 mm long stainless steel base.

8.0 mm ball with 4.0 mm carbide stem



Part Number	L1	Wt	Ruby	Silicon Nitride*	Zirconia**
TM3-8013	13.0	2.41	\$105.00	\$135.00	\$135.00
TM3-8020	20.0	3.68	\$105.00	\$135.00	\$135.00
TM3-8040	40.0	7.29	\$110.00	\$140.00	\$140.00
TM3-8050	50.0	9.10	\$115.00	\$145.00	\$145.00

M3 stylus with 8.0 mm diameter ball, 4.0 mm diameter carbide stem, and 4.0 mm diameter x 8.0 mm long stainless steel base.

*NOTE: For a **silicon nitride** ball, add **-SN** to the part number.

NOTE: For a **zirconia ball, add **-Z** to the part number.



WARNING: The products on this page can expose you to chemicals including cobalt, nickel, and phenylhydrazine, which are known to the State of California to cause cancer, and bisphenol A (BPA), which is known to the State of California to cause birth defects or other reproductive harm. For more information go to www.p65warnings.ca.gov.

M3 Threads

8.0 mm ball with 4.0 mm carbon fiber stem



Part Number	L1	Wt	Ruby	Silicon Nitride*	Zirconia**
TM3-8042-G	42.0	1.82	\$140.00	\$170.00	\$170.00
TM3-8050-G	50.0	1.97	\$140.00	\$170.00	\$170.00
TM3-8079-G	79.0	2.53	\$130.00	\$160.00	\$160.00
TM3-80104-G	104.0	3.01	\$140.00	\$170.00	\$170.00
TM3-80125-G	125.0	3.51	\$160.00	\$190.00	\$190.00

M3 stylus with 8.0 mm diameter ball, 4.0 mm diameter carbon fiber stem, and 4.0 mm diameter x 10.0 mm long stainless steel base.

Stainless steel styli

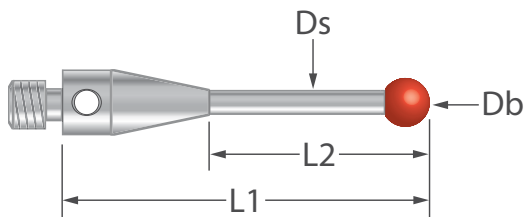

Part Number	Db	Ds	L1	L2	Wt	Ruby	Silicon Nitride*	Zirconia**
TM3-1021-S	1.0	0.7	21.0	4.0	0.93	\$30.00	\$60.00	\$60.00
TM3-1520.75-S	1.5	1.0	20.75	4.75	0.85	\$30.00	\$60.00	\$60.00
TM3-2022-S	2.0	1.4	22.0	9.0	0.82	\$30.00	\$60.00	\$60.00
TM3-3022.5-S	3.0	1.5	22.0	12.0	0.82	\$31.00	\$61.00	\$61.00
TM3-4023-S	4.0	2.5	23.0	14.0	1.60	\$31.00	\$61.00	\$61.00
TM3-4033-S	4.0	2.5	33.0	22.0	2.00	\$31.00	\$61.00	\$61.00
TM3-5023.5-S	5.0	2.5	23.5	16.5	1.60	\$32.00	\$62.00	\$62.00
TM3-5033.5-S	5.0	3.5	33.5	24.0	2.18	\$31.00	\$61.00	\$61.00
TM3-6010-S	6.0	2.5	10.0	6.0	1.44	\$45.00	\$75.00	\$75.00

M3 stylus with 4.0 mm diameter stainless steel base and stainless steel stem.

Important notes about cylinder styli

Cylinder styli are used for edge probing, for instance, the edges of stampings and thin sheet metal parts. Cylinder styli are not suitable for high accuracy work because the form of a cylinder is not as precise as a sphere. Please contact us with any questions about how to calibrate or use cylinder styli.

Ruby cylinder styli with stainless steel base



Part Number	Db	L1	Wt	Price
TM3-1014-B	1.0	14.0	0.46	\$148.00
TM3-1514-B	1.5	14.0	0.49	\$143.00

M3 stylus with ruby cylinder and 4.0 mm diameter x 5.0 mm long stainless steel base.

Ruby cylinder styli with carbide stem and stainless steel base

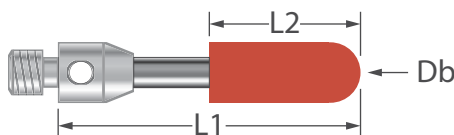

Part Number	Db	L1	L2	Wt	Price
TM3-2020-B	2.0	20.0	7.2	0.62	\$118.00
TM3-2030-B	2.0	30.0	7.2	0.69	\$118.00
TM3-4020-B	4.0	20.0	10.0	1.30	\$138.00
TM3-4030-B	4.0	30.0	10.0	1.75	\$138.00
TM3-4040-B	4.0	40.0	10.0	2.20	\$138.00

M3 stylus with ruby cylinder, carbide stem, and 4.0 mm diameter x 5.0 mm long stainless steel base.

Carbide cylinder styli with stainless steel base



Part Number	Db	L1	L2	Wt	Price
TM3-1014-BC	1.0	14.0	9.0	0.55	\$105.00
TM3-1032.4-BC	1.0	32.4	25.4	0.80	\$115.00
TM3-1515-BC	1.5	15.0	10.0	0.83	\$105.00
TM3-1540-BC	1.5	40.0	33.0	1.42	\$115.00
TM3-2025-BC	2.0	25.0	20.0	1.81	\$105.00
TM3-2040-BC	2.0	40.0	33.0	2.04	\$105.00
TM3-2075-BC	2.0	75.0	68.0	3.60	\$115.00
TM3-3040-BC	3.0	40.0	33.0	3.98	\$121.00
TM3-30100-BC	3.0	100.0	93.0	10.04	\$132.00

M3 stylus with carbide cylinder and 4.0 mm diameter stainless steel base.

*NOTE: For a **silicon nitride** ball, add -SN to the part number.

NOTE: For a **zirconia ball, add -Z to the part number.



WARNING: The products on this page can expose you to chemicals including cobalt, nickel, and phenylhydrazine, which are known to the State of California to cause cancer, and bisphenol A (BPA), which is known to the State of California to cause birth defects or other reproductive harm. For more information go to www.p65warnings.ca.gov.

M3 Threads

Steel cylinder styli

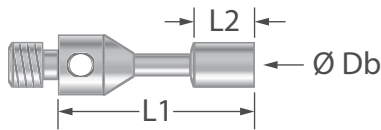

Part Number	Db	L1	L2	Wt	Ruby
TM3-1511-CYL	1.5	11.0	1.75	0.46	\$17.00
TM3-3013-CYL	3.0	13.0	4.0	0.70	\$17.00

M3 stylus with stainless steel cylinder and 4.0 mm diameter stainless steel base.

Carbide point styli

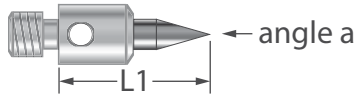

Part Number	a	L1	Wt	Ruby
TM3-S30-C	30.0	10.0	0.60	\$65.00
TM3-S60-C	60.0	10.0	0.58	\$65.00
TM3-S90-C	90.0	10.0	0.56	\$65.00

M3 stylus with 1.5 mm diameter carbide point and 4.0 mm diameter x 5.0 mm long stainless steel base.

Stylus extensions, stainless steel

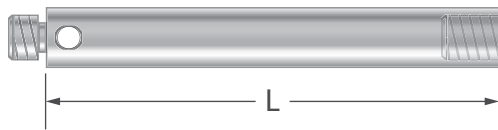

Part Number	L	Wt	Price
VM3-5	5.0	0.38	\$11.00
VM3-10	10.0	0.67	\$11.00
VM3-15	15.0	1.13	\$11.00
VM3-20	20.0	1.62	\$11.00
VM3-25	25.0	2.11	\$11.00
VM3-30	30.0	2.59	\$11.00
VM3-35	35.0	3.36	\$11.00
VM3-40	40.0	3.84	\$14.00
VM3-50	50.0	4.80	\$18.00
VM3-60	60.0	5.47	\$22.00
VM3-80	80.0	7.68	\$30.00
VM3-100	100.0	9.60	\$35.00
VM3-130	130.0	12.48	\$35.00
VM3-150	150.0	14.40	\$40.00
VM3-200	200.0	19.20	\$40.00

M3 extension. 4.0 mm diameter stainless steel.

Stylus extensions, ceramic and stainless steel

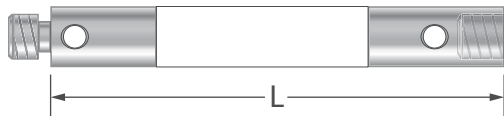

Part Number	L	Wt	Price
VM3-20-C	20.0	1.11	\$50.00
VM3-30-C	30.0	1.48	\$50.00
VM3-35-C	35.0	1.76	\$55.00
VM3-50-C	50.0	2.23	\$56.00
VM3-100-C	100.0	4.09	\$75.00

M3 extension. 4.0 mm diameter ceramic with stainless steel end fittings.

Stylus extensions, carbon fiber and stainless steel



Part Number	L	Wt	Price
VM3-20-G	20.0	0.80	\$65.00
VM3-30-G	30.0	0.95	\$65.00
VM3-50-G	50.0	1.25	\$66.00
VM3-75-G	75.0	1.62	\$85.00
VM3-100-G	100.0	1.99	\$90.00

M3 extension. 4.0 mm diameter carbon fiber with stainless steel end fittings.

Stylus extensions, titanium

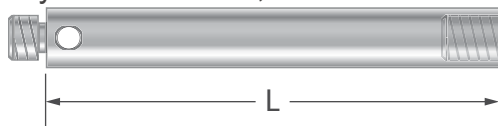

Part Number	L	Wt	Price
VM3-30-T	30.0	1.55	\$45.00
VM3-70-T	70.0	3.69	\$55.00

M3 extension. 4.0 mm diameter titanium.

M3 Threads

Stylus knuckle, fully adjustable

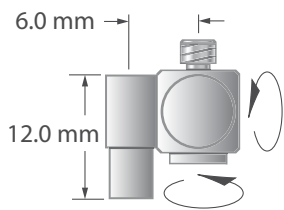

Part Number	Wt	Price
GM3-20	3.32	\$59.00

M3 stylus knuckle. Stainless steel. Includes hex wrench for adjustment (not shown).

Star hub, fully adjustable

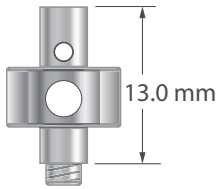

Part Number	Wt	Price
KM3-13	3.12	\$48.00

M3 star hub. Stainless steel. 9.5 mm between flats.

Rotary adapter

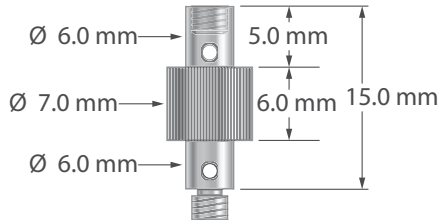

Part Number	Wt	Price
RAP-0513-M3	2.64	\$98.00

M3 rotary adapter. Stainless steel with knurled locking ring. Allows rotational adjustment of M3 components.

M3 star styli

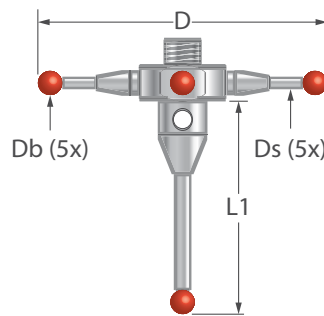
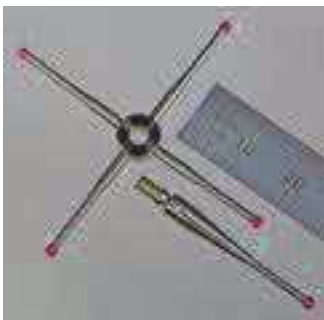

Part Number	D	L1	Ds	Wt	Price
STR3-2030	30.0	19.0	1.4	2.26	\$138.00
STR3-2050	50.0	29.0	1.4	5.11	\$138.00

M3 star styli with five 2.0 mm diameter ruby balls and 1.4 mm diameter stainless steel stems. Radially adjustable center hub is stainless steel.

M3 probe keys



Golf tee style. Suitable for both M2 and M3 components. Made of tool steel.

Part Number	Price
PK2-PK3	\$8.00



Offset style. Stainless steel handle with steel key.

Part Number	Price
PK-3	\$12.00



WARNING: The products on this page can expose you to chemicals including cobalt, nickel, and phenylhydrazine, which are known to the State of California to cause cancer, and bisphenol A (BPA), which is known to the State of California to cause birth defects or other reproductive harm. For more information go to www.p65warnings.ca.gov.

M3 XXT titanium technology



0.3 mm ruby ball with tapered carbide stem

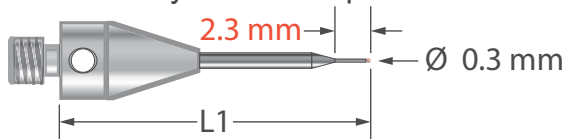

M3 stylus with 0.3 mm diameter ruby ball, tapered carbide stem, and 5.0 mm diameter x 9.0 mm long titanium base. Minor stem diameter is 0.2 mm and major diameter is 1.0 mm.

Part Number	L1	Wt	Price
TM3-0313-TX	13.0	0.46	\$95.00
TM3-0315-TX	15.0	0.49	\$95.00
TM3-0318-TX	18.0	0.51	\$95.00
TM3-0320-TX	20.0	0.54	\$95.00

0.5 mm ruby ball with tapered carbide stem

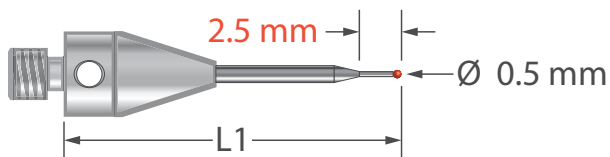

M3 stylus with 0.5 mm diameter ruby ball, tapered carbide stem, and 5.0 mm diameter x 9.0 mm long titanium base. Minor stem diameter is 0.3 mm and major diameter is 1.0 mm.

Part Number	L1	Wt	Price
TM3-0513-TX	13.0	0.53	\$95.00
TM3-0515-TX	15.0	0.53	\$95.00
TM3-0518-TX	18.0	0.54	\$105.00
TM3-0520-TX	20.0	0.55	\$95.00
TM3-0524-TX	24.0	0.57	\$102.00

0.5 mm ruby ball star with four styli

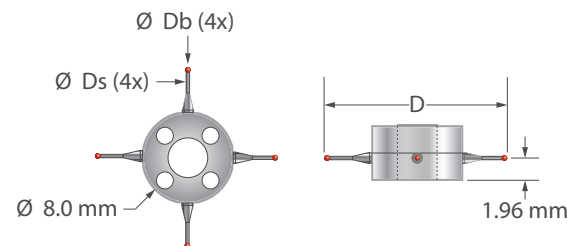

Four-way M3 star stylus with four 0.5 mm diameter ruby balls, tapered carbide stems, and two-piece clamping titanium hub. Individual styli can be replaced or adjusted by unscrewing the two-piece hub.

Part Number	Db	Ds	D	Wt	Price
XXT-STR-0516	0.5	0.3	16.0	0.89	\$460.00
XXT-STR-0818	0.8	0.6	18.0	1.04	\$375.00
XXT-STR-1020	1.0	0.8	20.0	1.10	\$350.00

0.6 mm ruby or silicon nitride ball with stepped carbide stem

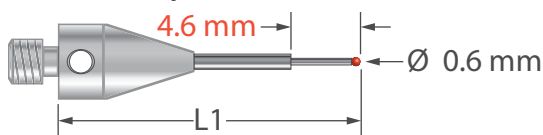

M3 stylus with 0.6 mm diameter ruby or silicon nitride ball, stepped carbide stem, and 5.0 mm diameter x 9.0 mm long titanium base. Minor stem diameter is 0.4 mm and major diameter is 1.0 mm.

Part Number	L1	Wt	Ruby	Silicon Nitride*
TM3-0614-TX	14.0	0.53	\$92.00	\$122.00
TM3-0617-TX	17.0	0.55	\$92.00	\$122.00
TM3-0620-TX	20.0	0.57	\$92.00	\$122.00
TM3-0624-TX	24.0	0.61	\$92.00	\$122.00

0.8 mm ruby ball with stepped carbide stem

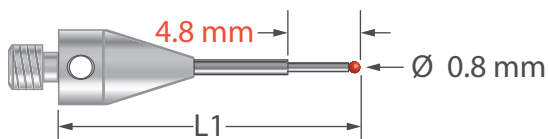

M3 stylus with 0.8 mm diameter ruby ball, tapered carbide stem, and 5.0 mm diameter x 9.0 mm long titanium base. Minor stem diameter is 0.6 mm and major diameter is 1.0 mm.

Part Number	L1	Wt	Price
TM3-0814-TX	14.0	0.54	\$77.00
TM3-0817-TX	17.0	0.57	\$80.00
TM3-0820-TX	20.0	0.60	\$80.00
TM3-0825-TX	25.0	0.65	\$85.00
TM3-0835-TX	35.0	0.75	\$79.00

1.0 mm ball with stepped carbide stem

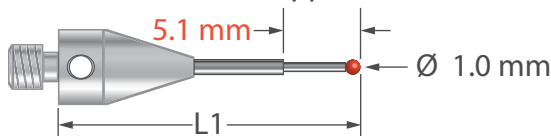

M3 stylus with 1.0 mm diameter ball, stepped carbide stem, and 5.0 mm diameter x 9.0 mm long titanium base. Minor stem diameter is 0.6 mm, major diameter is 1.0 mm.

Part Number	L1	Wt	Ruby	Silicon Nitride*	Zirconia**
TM3-1020-TX-6	20.0	0.61	\$74.00	\$110.00	\$110.00



WARNING: The products on this page can expose you to chemicals including cobalt, nickel, and phenylhydrazine, which are known to the State of California to cause cancer, and bisphenol A (BPA), which is known to the State of California to cause birth defects or other reproductive harm. For more information go to www.p65warnings.ca.gov.

M3 XXT titanium technology



1.0 mm ball with 0.8 mm carbide stem



Part Number	L1	Wt	Ruby	Silicon Nitride*	Zirconia**
TM3-1014-TX-8	14.0	0.58	\$79.00	\$94.00	\$94.00
TM3-1017-TX-8	17.0	0.68	\$85.00	\$115.00	\$115.00
TM3-1020-TX-8	20.0	0.71	\$74.00	\$104.00	\$104.00
TM3-1025-TX-8	25.0	0.75	\$80.00	\$110.00	\$110.00
TM3-1031-TX-8	31.0	0.78	\$85.00	\$115.00	\$115.00
TM3-1035-TX-8	35.0	0.82	\$90.00	\$120.00	\$120.00
TM3-1040-TX-8	40.0	0.88	\$90.00	\$120.00	\$120.00

M3 stylus with 1.0 mm diameter ruby ball, 0.8 mm diameter carbide stem, and 5.0 mm diameter x 9.0 mm long titanium base.

1.0 mm ball with stepped carbide stem

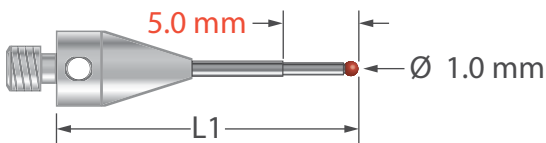

Part Number	L1	Wt	Ruby	Silicon Nitride*	Zirconia**
TM3-1020-TX	20.0	0.61	\$79.00	\$94.00	\$94.00
TM3-1025-TX	25.0	0.71	\$80.00	\$98.00	\$98.00
TM3-1030-TX	30.0	0.76	\$79.00	\$96.00	\$96.00
TM3-1031-TX	31.0	0.77	\$79.00	\$100.00	\$94.00
TM3-1035-TX	35.0	0.82	\$79.00	\$99.00	\$99.00
TM3-1040-TX	40.0	0.89	\$79.00	\$102.00	\$102.00

M3 stylus with 1.0 mm diameter ball, stepped carbide stem, and 5.0 mm diameter x 9.0 mm long titanium base. Minor stem diameter is 0.8 mm, major diameter is 1.0 mm.

1.35 mm ball with 1.0 mm carbide stem

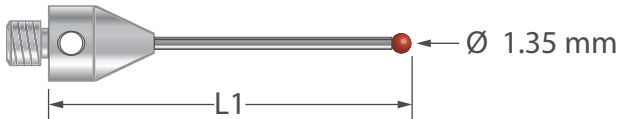

Part Number	L1	Wt	Ruby	Silicon Nitride*
TM3-1324-TX	24.0	0.70	\$95.00	\$125.00
TM3-1331-TX	31.0	0.78	\$98.00	\$128.00

M3 stylus with 1.35 mm diameter ball, 1.0 mm diameter carbide stem, and 5.0 mm diameter x 7.0 mm long titanium base.

1.5 mm ball with 1.0 mm carbide stem

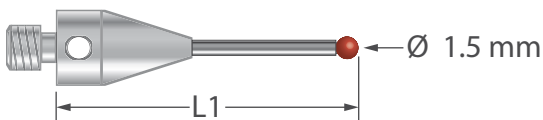

Part Number	L1	Wt	Ruby	Silicon Nitride*	Zirconia**
TM3-1514-TX	14.0	0.57	\$64.00	\$94.00	\$94.00
TM3-1517-TX	17.0	0.60	\$64.00	\$99.00	\$99.00
TM3-1520-TX	20.0	0.63	\$64.00	\$89.00	\$89.00
TM3-1525-TX	25.0	0.69	\$64.00	\$99.00	\$99.00
TM3-1530-TX	30.0	0.75	\$64.00	\$89.00	\$94.00
TM3-1540-TX	40.0	0.86	\$64.00	\$89.00	\$89.00

M3 stylus with 1.5 mm diameter ball, 1.0 mm diameter carbide stem, and 5.0 mm diameter x 9.0 mm long titanium base.

1.5 mm ball with 1.0 mm carbide stem and 7.5 mm long titanium base

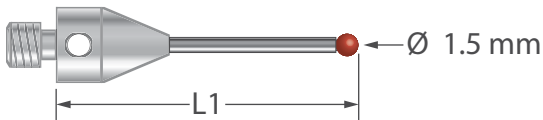

Part Number	L1	Wt	Ruby	Silicon Nitride*	Zirconia**
TM3-1530-TX-7.5	30.0	0.85	\$105.00	\$135.00	\$135.00

M3 stylus with 1.35 mm diameter ball, 1.0 mm diameter carbide stem, and 5.0 mm diameter x 7.5 mm long titanium base.

2.0 mm ball with 1.0 mm carbide stem



Part Number	L1	Wt	Ruby	Silicon Nitride*	Zirconia**
TM3-2014-TX	14.0	0.58	\$80.00	\$105.00	\$105.00
TM3-2017-TX	17.0	0.61	\$80.00	\$105.00	\$105.00
TM3-2020-TX	20.0	0.64	\$80.00	\$105.00	\$105.00
TM3-2025-TX	25.0	0.70	\$83.00	\$105.00	\$105.00
TM3-2030-TX	30.0	0.75	\$83.00	\$105.00	\$110.00

M3 stylus with 2.0 mm diameter ball, 1.0 mm diameter carbide stem, and 5.0 mm diameter x 9.0 mm long titanium base.

*NOTE: For a **silicon nitride** ball, add -SN to the part number.

NOTE: For a **zirconia ball, add -Z to the part number.



WARNING: The products on this page can expose you to chemicals including cobalt, nickel, and phenylhydrazine, which are known to the State of California to cause cancer, and bisphenol A (BPA), which is known to the State of California to cause birth defects or other reproductive harm. For more information go to www.p65warnings.ca.gov.

M3 XXT titanium technology



2.0 mm ball with 1.5 mm carbide stem

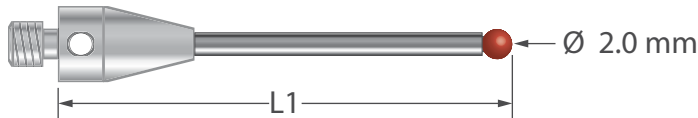

Part Number	L1	Wt	Ruby	Silicon Nitride*	Zirconia**
TM3-2035-TX	35.0	1.37	\$85.00	\$115.00	\$115.00
TM3-2040-TX	40.0	1.49	\$95.00	\$125.00	\$125.00
TM3-2054-TX	54.0	1.84	\$90.00	\$120.00	\$120.00

M3 stylus with 2.0 mm diameter ball, 1.5 mm diameter carbide stem, and 5.0 mm diameter x 9.0 mm long titanium base.

2.5 mm ball with 1.5 mm carbide stem

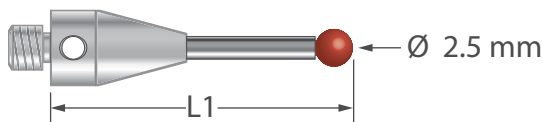

Part Number	L1	Wt	Ruby	Silicon Nitride*	Zirconia**
TM3-2520-TX	20.0	0.79	\$74.00	\$98.00	\$98.00
TM3-2525-TX	25.0	0.91	\$74.00	\$104.00	\$104.00
TM3-2530-TX	30.0	1.03	\$74.00	\$99.00	\$99.00
TM3-2535-TX	35.0	1.15	\$74.00	\$115.00	\$115.00
TM3-2540-TX	40.0	1.28	\$74.00	\$99.00	\$99.00

M3 stylus with 2.5 mm diameter ball, 1.5 mm diameter carbide stem, and 5.0 mm diameter x 9.0 mm long titanium base.

3.0 mm ball with 2.0 mm carbon fiber stem



Part Number	L1	Wt	Ruby	Silicon Nitride*	Zirconia**
TM3-3025-TX	25.0	0.57	\$110.00	\$140.00	\$140.00
TM3-3033-TX	33.0	0.61	\$115.00	\$140.00	\$140.00
TM3-3040-TX	40.0	0.64	\$115.00	\$140.00	\$140.00
TM3-3042-TX	42.0	0.65	\$115.00	\$140.00	\$140.00
TM3-3050-TX	50.0	0.69	\$115.00	\$140.00	\$140.00
TM3-3058-TX	58.0	0.72	\$130.00	\$150.00	\$150.00
TM3-3065-TX	65.0	0.76	\$130.00	\$160.00	\$160.00
TM3-3075-TX	75.0	0.80	\$130.00	\$160.00	\$160.00
TM3-3084-TX	84.0	0.85	\$135.00	\$160.00	\$160.00
TM3-30100-TX	100.0	0.92	\$138.00	\$160.00	\$168.00
TM3-30125-TX	125.0	1.04	\$135.00	\$160.00	\$160.00

M3 stylus with 3.0 mm diameter ball, 2.0 mm diameter carbon fiber stem, and 5.0 mm diameter x 9.0 mm long titanium base.

4.0 mm ball with carbon fiber stem

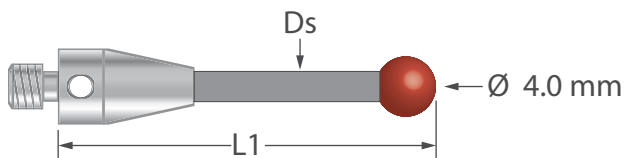

Part Number	L1	Ds	Wt	Ruby	Silicon Nitride*	Zirconia**
TM3-4025-TX	25.0	2.0	0.61	\$102.00	\$132.00	\$132.00
TM3-4050-TX	50.0	2.0	0.73	\$130.00	\$150.00	\$150.00
TM3-4052-TX	52.0	2.5	0.95	\$130.00	\$130.00	\$130.00
TM3-4075-TX	75.0	2.5	1.27	\$130.00	\$165.00	\$165.00
TM3-4090-TX	90.0	3.0	1.49	\$175.00	\$175.00	\$175.00

M3 stylus with 4.0 mm diameter ball, carbon fiber stem, and 5.0 mm diameter x 9.0 mm long titanium base.

5.0 mm ball with 3.5 mm carbon fiber stem



Part Number	L1	Wt	Ruby	Silicon Nitride*	Zirconia**
TM3-5030-TX	30.0	0.80	\$130.00	\$155.00	\$155.00
TM3-5040-TX	40.0	0.95	\$130.00	\$155.00	\$155.00
TM3-5050-TX	50.0	1.10	\$130.00	\$160.00	\$160.00
TM3-5060-TX	60.0	1.25	\$130.00	\$155.00	\$155.00
TM3-5075-TX	75.0	1.47	\$145.00	\$170.00	\$170.00
TM3-50100-TX	100.0	1.84	\$145.00	\$175.00	\$175.00

M3 stylus with 5.0 mm diameter ball, 3.5 mm diameter carbon fiber stem, and 5.0 mm diameter x 9.0 mm long titanium base.

6.0 mm ball with 3.5 mm carbon fiber stem



Part Number	L1	Wt	Ruby	Silicon Nitride*	Zirconia**
TM3-6050-TX	50.0	1.33	\$150.00	\$155.00	\$155.00
TM3-6070-TX	70.0	1.63	\$145.00	\$170.00	\$170.00
TM3-60100-TX	100.0	2.08	\$165.00	\$195.00	\$195.00
TM3-60103-TX	103.0	2.12	\$165.00	\$195.00	\$195.00

M3 stylus with 6.0 mm diameter ball, 3.5 mm diameter carbon fiber stem, and 5.0 mm diameter x 9.0 mm long titanium base.

*NOTE: For a **silicon nitride** ball, add **-SN** to the part number.

NOTE: For a **zirconia ball, add **-Z** to the part number.

WARNING: The products on this page can expose you to chemicals including cobalt, nickel, and phenylhydrazine, which are known to the State of California to cause cancer, and bisphenol A (BPA), which is known to the State of California to cause birth defects or other reproductive harm. For more information go to www.p65warnings.ca.gov.

M3 XXT titanium technology



8.0 mm ball with 5.0 mm carbon fiber stem

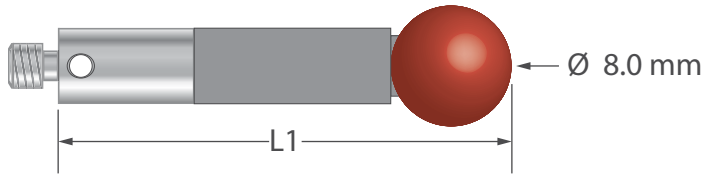

Part Number	L1	Wt	Ruby	Silicon Nitride*	Zirconia**
TM3-8030-TX	30.0	1.74	\$160.00	\$185.00	\$185.00
TM3-8050-TX	80.0	2.34	\$160.00	\$190.00	\$190.00
TM3-8070-TX	70.0	2.94	\$160.00	\$185.00	\$185.00
TM3-80100-TX	100.0	3.84	\$185.00	\$210.00	\$210.00
TM3-80125-TX	125.0	4.59	\$190.00	\$220.00	\$220.00

M3 stylus with 8.0 mm diameter ball, 5.0 mm diameter carbon fiber stem, and 5.0 mm diameter x 9.0 mm long titanium base.

XXT extensions, carbon fiber body with titanium end fittings



Part Number	L1	Wt	Price
VM3-20-TX	20.0	0.82	\$80.00
VM3-25-TX	25.0	0.97	\$80.00
VM3-30-TX	30.0	1.12	\$85.00
VM3-35-TX	35.0	1.27	\$85.00
VM3-40-TX	40.0	1.42	\$90.00
VM3-45-TX	45.0	1.57	\$95.00
VM3-50-TX	50.0	1.72	\$100.00
VM3-60-TX	60.0	2.02	\$100.00
VM3-65-TX	65.0	2.17	\$105.00
VM3-75-TX	75.0	2.47	\$110.00
VM3-80-TX	80.0	2.62	\$110.00
VM3-90-TX	90.0	2.92	\$130.00
VM3-100-TX	100.0	3.22	\$135.00
VM3-105-TX	105.0	3.37	\$140.00
VM3-120-TX	120.0	3.82	\$140.00
VM3-130-TX	130.0	3.97	\$145.00
VM3-140-TX	140.0	4.42	\$150.00
VM3-150-TX	150.0	4.57	\$165.00

M3 extension with 5.0 mm diameter carbon fiber stem and 5.0 mm diameter titanium end fittings.

XXT adapter plates



XXT-AP-ID



XXT-AP-ID3

Part Number	Fits	Wt	Price
XXT-AP-ID	TL1	4.59	\$350.00
XXT-AP-ID3	TL3	4.59	\$350.00

M3 adapter plate with ID chip for XXT-ID TL1. M3 adapter plate with ID chip for XXT-ID TL3.

Delrin® XXT Plates



Part Number	Fits	Wt	Price
XXT-AP-ID-D	TL1	3.28	\$410.00
XXT-AP-ID3-D	TL3	3.28	\$410.00

Lightweight M3 adapter plates with ID chip for XXT-ID TL1 and XXT-ID TL3.



WARNING: The products on this page can expose you to chemicals including cobalt, nickel, and phenylhydrazine, which are known to the State of California to cause cancer, and bisphenol A (BPA), which is known to the State of California to cause birth defects or other reproductive harm. For more information go to www.p65warnings.ca.gov.

M3 XXT titanium technology



XXT Adapter plates with carbon fiber extensions and titanium star fittings

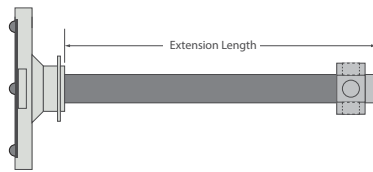

Part Number	Extension Length	Fits	Wt	Price
XXT-AP-ID-STR	55.0	TL1	6.90	\$450.00
XXT-AP-ID3-STR	55.0	TL3	6.90	\$450.00
XXT-AP-ID3-STR-75	75.0	TL3	7.50	\$495.00
XXT-AP-ID3-STR-100	100.0	TL3	8.25	\$495.00
XXT-AP-ID3-STR-125	125.0	TL3	8.98	\$495.00

XXT adapter plates with carbon fiber extensions and titanium end fittings with five M3 internal threads.

XXT clamping screw

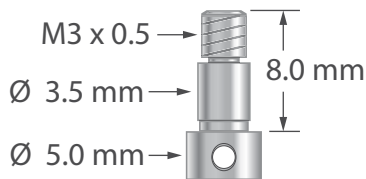

Part Number	Wt	Price
XXT-CS	0.48	\$25.00

M3 titanium clamping screw. Used to assemble cubes or knuckles to adapter plates.

XXT clamping screw with internal M3 thread

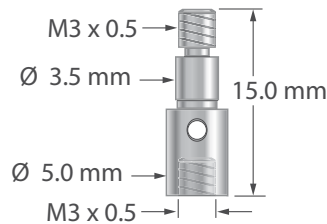

Part Number	Wt	Price
XXT-M3-CS	0.66	\$30.00

M3 titanium clamping screw with internal M3 thread. Used to assemble other XXT parts to adapter plates. The internal thread can hold an additional stylus in the minus Z direction.

XXT single-sided cube

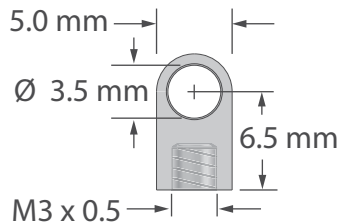

Part Number	Wt	Price
XXT-90	0.54	\$75.00

M3 titanium single-sided cube with one internal thread.

XXT double-sided cube

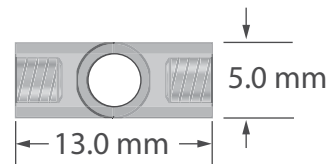

Part Number	Wt	Price
XXT-180	0.90	\$80.00

M3 titanium double-sided cube with two internal threads.

XXT four-sided cube

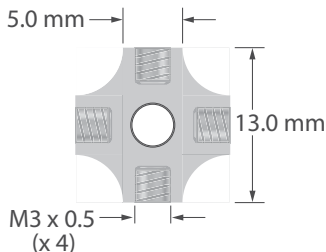

Part Number	Wt	Price
XXT-WM3-13	1.64	\$85.00

M3 titanium four-sided cube with four internal threads and 3.5 mm diameter through hole. 5.0 mm thick.

XXT knuckle joint

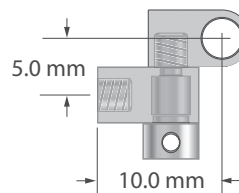

Part Number	Wt	Price
XXT-JM3	1.58	\$190.00

M3 titanium knuckle joint, fully adjustable. Three piece assembly. 3.5 mm diameter through hole



WARNING: The products on this page can expose you to chemicals including cobalt, nickel, and phenylhydrazine, which are known to the State of California to cause cancer, and bisphenol A (BPA), which is known to the State of California to cause birth defects or other reproductive harm. For more information go to www.p65warnings.ca.gov.

M3 XXT titanium technology



XXT six-sided hub



Part Number	Wt	Price
XXT-HUB-6	1.77	\$110.00

M3 titanium six-sided hub with six internal threads and 3.5 mm diameter through hole. 5.0 mm thick.

XXT eight-sided hub



Part Number	Wt	Price
XXT-HUB-8	2.24	\$125.00

M3 titanium eight-sided hub with eight internal threads and 3.5 mm diameter through hole. 5.0 mm thick.

XXT styli, single end

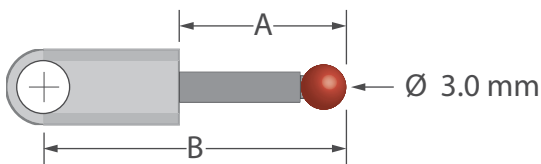

Part Number	A	B	Wt	Ruby	Silicon Nitride*
XXT-3020-L	11.0	20.0	0.72	\$145.00	\$175.00
XXT-3030-L	21.0	30.0	0.74	\$150.00	\$180.00
XXT-3040-L	31.0	40.0	0.82	\$155.00	\$185.00

XXT styli. 5.0 mm thick titanium fitting with 3.5 mm diameter through hole. Single 2.0 mm diameter carbon fiber stem with a 3.0 mm diameter ball. Used with a clamping screw (page 28) or clamping stylus (page 30).

XXT styli, double end

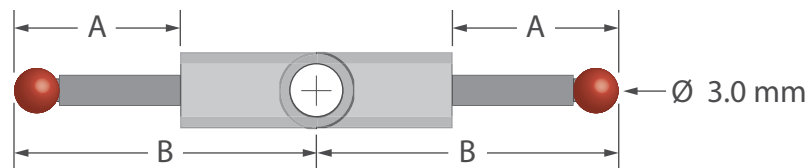

Part Number	A	B	Wt	Ruby	Silicon Nitride*
XXT-3020-180	11.0	20.0	1.34	\$265.00	\$295.00
XXT-3030-180	21.0	30.0	1.44	\$270.00	\$300.00
XXT-3040-180	31.0	40.0	1.54	\$275.00	\$305.00

XXT styli, 180 degrees. 5.0 mm square titanium center fitting with 3.5 mm diameter through hole. Two 2.0 mm diameter carbon fiber stems with 3.0 mm diameter balls. Used with a clamping screw (page 28) or clamping stylus (page 30).

XXT styli, 90 degrees

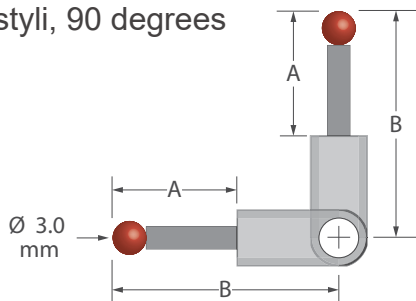

Part Number	A	B	Wt	Ruby	Silicon Nitride*
XXT-3020-90	11.0	20.0	1.34	\$265.00	\$295.00
XXT-3030-90	21.0	30.0	1.44	\$270.00	\$300.00
XXT-3040-90	31.0	40.0	1.54	\$275.00	\$305.00

XXT styli, 90 degrees. 5.0 mm thick titanium center fitting with 3.5 mm diameter through hole. Two 2.0 mm diameter carbon fiber stems with 3.0 mm diameter balls. Used with a clamping screw (page 28) or clamping stylus (page 30).

XXT clamping styli

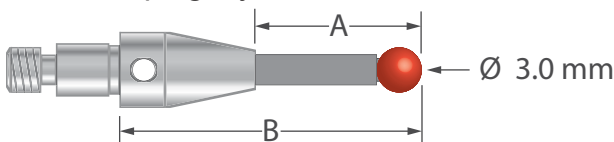

Part Number	A	B	Wt	Ruby	Silicon Nitride*
TM3-3020-TX-CS	11.0	20.0	0.72	\$112.00	\$120.00
TM3-3030-TX-CS	21.0	30.0	0.81	\$116.00	\$122.00
TM3-3040-TX-CS	31.0	40.0	1.54	\$117.00	\$130.00

XXT clamping styli with 3.0 mm diameter ball, 2.0 mm diameter carbon fiber stem, and 5.0 mm diameter x 9.0 mm long titanium base.

**NOTE: For a silicon nitride ball, add -SN to the part number.*



WARNING: The products on this page can expose you to chemicals including cobalt, nickel, and phenylhydrazine, which are known to the State of California to cause cancer, and bisphenol A (BPA), which is known to the State of California to cause birth defects or other reproductive harm. For more information go to www.p65warnings.ca.gov.

M3 XXT titanium technology



M3 Pro Fit threaded angle blocks, titanium

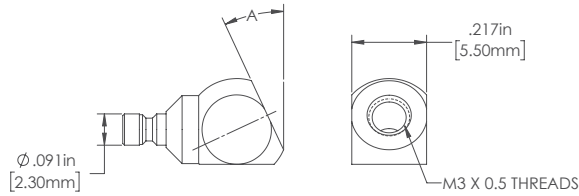

Part Number	Angle "A"	Wt	Price
WM3-5-PF-25	25.0	0.81	\$115.00
WM3-5-PF-30	30.0	0.81	\$115.00
WM3-5-PF-35	35.0	0.80	\$115.00
WM3-5-PF-40	40.0	0.80	\$115.00
WM3-5-PF-45	45.0	0.79	\$115.00
WM3-5-PF-55	55.0	0.77	\$115.00
WM3-5-PF-60	60.0	0.76	\$115.00
WM3-5-PF-90	90.0	0.71	\$115.00

M3 angled blocks with cone receptor. Titanium.

M3 Pro Fit rotary adapter with conical receiver and special wrench

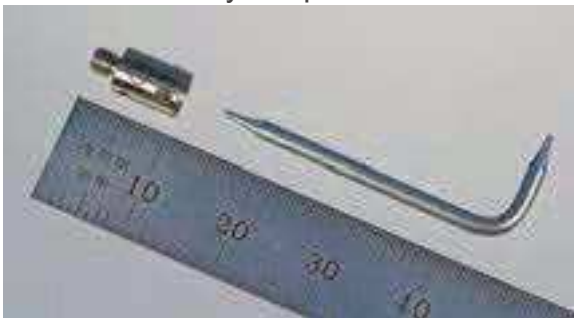

Part Number	Wt	Price
RAP-5PF-CE	0.85	\$115.00

M3 Pro Fit rotary adapter with conical receiver. Allows unlimited radial adjustment. Three M1.2 set screws are tightened with special wrench (shown). 5.0 mm diameter x 7.0 mm long. Stainless steel. Designed for Pro Fit threaded angle blocks, above.

M3 XXT Stylus Kit



Part Number	Description	Qty
TM3-1031-TX-8	1.0 mm ruby stylus	2
TM3-1530-TX	1.5 mm ruby stylus	2
TM3-2040-TX	2.0 mm ruby stylus	2
TM3-3050-TX	3.0 mm ruby stylus	2
VM3-100-TX	100 mm extension	1
VM3-50-TX	50 mm extension	1
PK3	Probe key	2
XXT-CS	Clamping screw	1
XXT-M3-CS	Clamping screw	1
XXT-WM3-13	Four-sided cube	1
XXT-AP-ID3	Adapter plate, TL3	1



M3 XXT stylus kit consisting of sixteen items and protective case. Includes one adapter plate for TL3 probe head. A \$1,507.00 value if sold separately.

Part Number	Price
XXT-TL3-KIT	\$1,400.00



WARNING: The products on this page can expose you to chemicals including cobalt, nickel, and phenylhydrazine, which are known to the State of California to cause cancer, and bisphenol A (BPA), which is known to the State of California to cause birth defects or other reproductive harm. For more information go to www.p65warnings.ca.gov.

M4 Threads

M4 stylus with 1.0 mm ruby ball, stainless steel body and stem

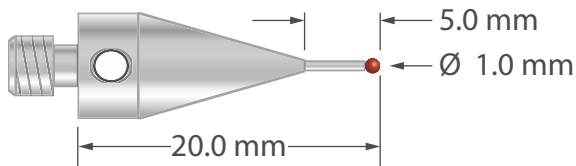

Part Number	Wt	Price
TM4-1020-S	2.64	\$85.00

M4 stylus with 1.0 mm diameter ruby ball, 0.7 mm diameter stainless steel stem, and 7.0 mm diameter stainless steel base.

M4 stylus with 2.0 mm ruby ball, stainless steel body and stem

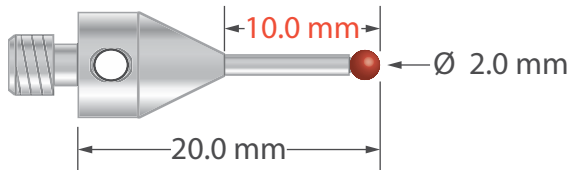

Part Number	Wt	Price
TM4-2020-S	2.14	\$70.00

M4 stylus with 2.0 mm diameter ruby ball, 1.4 mm diameter stainless steel stem, and 7.0 mm diameter stainless steel base.

M4 stylus with 3.0 mm ruby ball, stainless steel body and stem

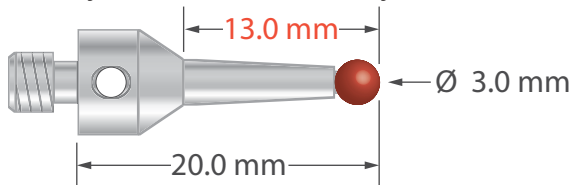

Part Number	Wt	Price
TM4-3020-S	2.04	\$40.00

M4 stylus with 3.0 mm diameter ruby ball, tapered stainless steel stem, and 7.0 mm diameter stainless steel base.

M4 stylus with 4.0 mm ruby ball, stainless steel body and stem

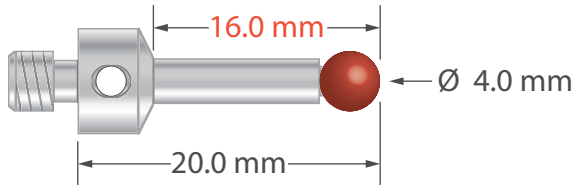

Part Number	Wt	Price
TM4-4020-S	2.24	\$42.00

M4 stylus with 4.0 mm diameter ruby ball, 3.0 mm diameter stainless steel stem, and 7.0 mm diameter stainless steel base.

M4 styli with 5.0 mm ruby ball, stainless steel body and stem

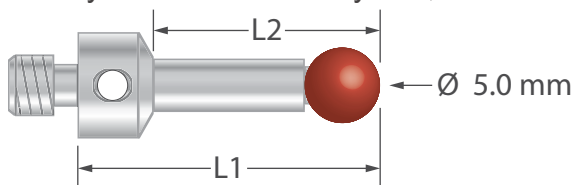

Part Number	L1	L2	Wt	Price
TM4-5012.5-S	12.5	7.5	2.01	\$65.00
TM4-5020-S	20.0	15.0	2.45	\$42.00
TM4-5022.5-S	22.5	17.5	2.53	\$65.00
TM4-5032.5-S	32.5	27.5	3.02	\$65.00

M4 stylus with 5.0 mm diameter ruby ball, 3.5 mm diameter stainless steel stem, and 7.0 mm diameter stainless steel base.

M4 styli with 5.0 mm ruby ball, stainless steel body and stem

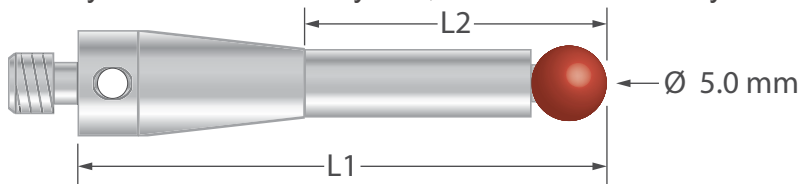

Part Number	L1	L2	Wt	Price
TM4-5052.5-S	52.5	36.5	8.36	\$65.00
TM4-50102.5-S	102.5	85.5	15.75	\$75.00
TM4-50152.5-S	152.5	132.5	19.62	\$85.00

M4 stylus with 5.0 mm diameter ruby ball, 4.5 mm diameter stainless steel stem, and 7.0 mm diameter stainless steel base.



WARNING: The products on this page can expose you to chemicals including cobalt, nickel, and phenylhydrazine, which are known to the State of California to cause cancer, and bisphenol A (BPA), which is known to the State of California to cause birth defects or other reproductive harm. For more information go to www.p65warnings.ca.gov.

M4 Threads

M4 stylus with 6.0 mm ruby ball, stainless steel body and stem

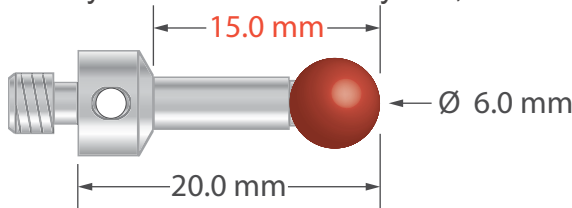

Part Number	Wt	Price
TM4-6020-S	3.00	\$45.00

M4 stylus with 6.0 mm diameter ruby ball, 4.5 mm diameter stainless steel stem, and 7.0 mm diameter stainless steel base.

M4 stylus with 8.0 mm ruby ball, stainless steel body and stem

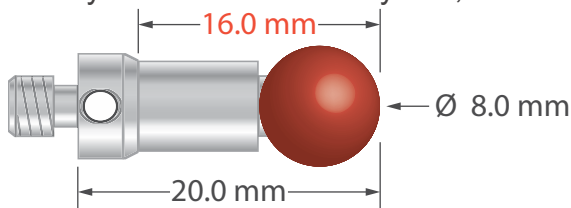

Part Number	Wt	Price
TM4-8020-S	4.28	\$65.00

M4 stylus with 8.0 mm diameter ruby ball, 6.0 mm diameter stainless steel stem, and 7.0 mm diameter stainless steel base.

M4 styli with ruby ball, stainless steel body, and carbide stem

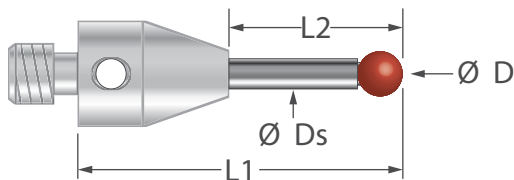

Part Number	D	Ds	L1	L2	Wt	Price
TM4-1020.5-DS.7	1.0	0.7	20.5	10.5	2.13	\$75.00
TM4-2021	2.0	1.5	21.0	11.0	2.45	\$69.00
TM4-3021.5	3.0	2.0	21.5	11.5	2.68	\$69.00
TM4-4022	4.0	2.0	22.0	12.0	2.74	\$69.00
TM4-6023	6.0	2.5	23.0	13.0	3.24	\$85.00

M4 stylus with ruby ball, carbide stem, and 7.0 mm diameter x 10.0 mm long stainless steel base.

M4 styli with ruby ball, stainless steel body, and carbide stem

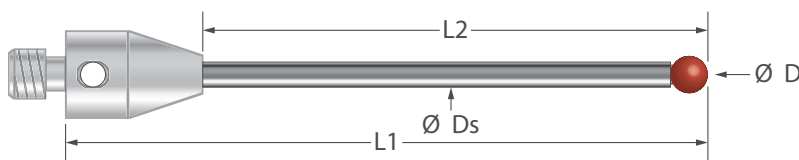

Part Number	D	Ds	L1	L2	Wt	Price
TM4-2051	2.0	1.5	51.0	41.0	3.19	\$79.00
TM4-3051.5	3.0	2.0	51.5	41.5	4.02	\$80.00
TM4-4052	4.0	2.5	52.0	42.0	4.08	\$85.00
TM4-5052.5	5.0	2.5	52.5	42.5	5.12	\$88.00
TM4-6053	6.0	2.5	53.0	39.0	5.28	\$88.00

M4 stylus with ruby ball, carbide stem, and 7.0 mm diameter stainless steel base.

M4 styli with ruby ball, stainless steel body, and ceramic stem

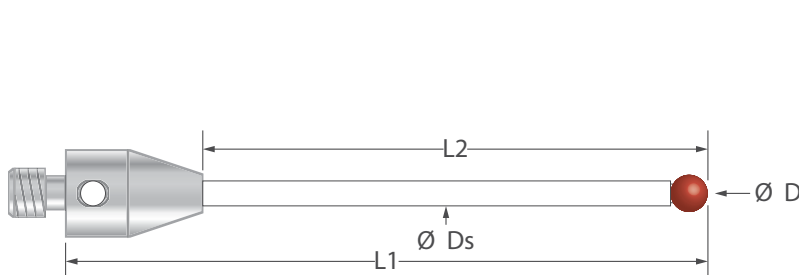

Part Number	D	Ds	L1	L2	Wt	Price
TM4-3041.5-C	3.0	2.0	41.5	31.5	2.59	\$67.00
TM4-4052-C	4.0	3.0	52.0	42.0	3.11	\$65.00
TM4-5052.5-C	5.0	3.5	52.5	42.5	3.71	\$69.00
TM4-5077.5-C	5.0	3.5	77.5	67.5	4.64	\$75.00
TM4-50102.5-C	5.0	3.5	102.5	90.5	5.91	\$135.00
TM4-6053-C	6.0	4.5	53.0	43.0	4.68	\$90.00
TM4-6078-C	6.0	4.5	78.0	68.0	6.23	\$90.00
TM4-60103-C	6.0	4.5	103.0	91.0	7.95	\$105.00
TM4-60153-C	6.0	4.5	153.0	141.0	11.06	\$145.00
TM4-8054-C	8.0	4.5	54.0	42.0	5.14	\$98.00
TM4-8079-C	8.0	4.5	79.0	67.0	6.69	\$105.00
TM4-80104-C	8.0	4.5	104.00	92.0	8.41	\$130.00

M4 stylus with ruby ball, ceramic stem, and 7.0 mm diameter stainless steel base.



WARNING: The products on this page can expose you to chemicals including cobalt, nickel, and phenylhydrazine, which are known to the State of California to cause cancer, and bisphenol A (BPA), which is known to the State of California to cause birth defects or other reproductive harm. For more information go to www.p65warnings.ca.gov.

M4 Threads

M4 styli with 6.0 mm ruby ball, stainless steel body, and carbon fiber stem

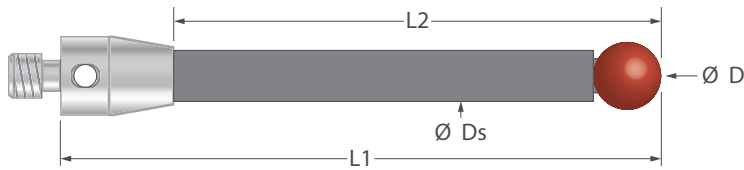

Part Number	D	L1	L2	Wt	Price
TM4-6053-G	6.0	53.0	43.0	3.18	\$105.00
TM4-60103-DS4.5-G	6.0	103.0	91.0	4.58	\$130.00
TM4-60153-G	6.0	153.0	138.0	6.05	\$160.00
TM4-60203-G	6.0	203.0	188.0	7.28	\$190.00
TM4-60303-G	6.0	303.0	288.0	9.73	\$248.00
TM4-80304-G	8.0	304.0	288.0	10.25	\$350.00

M4 stylus with ruby ball, 4.5 mm diameter carbon fiber stem, and 7.0 mm diameter stainless steel base.

M4 extensions, stainless steel

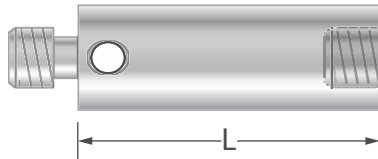

M4 extension, 7.0 mm diameter stainless steel.

Part Number	L	Wt	Price
VM4-10	10.0	1.52	\$29.00
VM4-15	15.0	3.68	\$30.00
VM4-20	20.0	5.43	\$30.00
VM4-30	30.0	8.35	\$30.00
VM4-50	50.0	14.25	\$35.00

M4 extensions, ceramic body with stainless steel end fittings



M4 extension, 6.0 mm diameter ceramic with 7.0 mm diameter stainless steel fittings.

Part Number	L	Wt	Price
VM4-30-C	30.0	6.33	\$50.00
VM4-50-C	50.0	8.40	\$58.00
VM4-100-C	100.0	13.58	\$125.00
VM4-200-C	200.0	23.94	\$150.00

M4 stylus with 3.0 mm carbide ball and stainless steel base and stem, electrically conductive

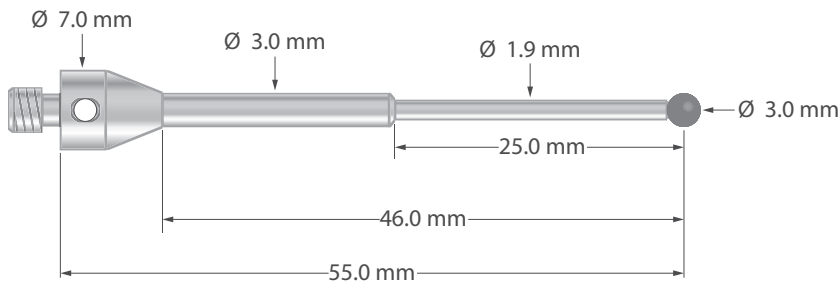

M4 stylus with 3.0 mm diameter carbide ball and stainless steel base and stem. Stylus is electrically conductive.

Part Number	Wt	Price
TM4-3056.5-EC	3.82	\$146.00

M4 styli with 5.0 mm carbide ball and stainless steel base and stem, electrically conductive

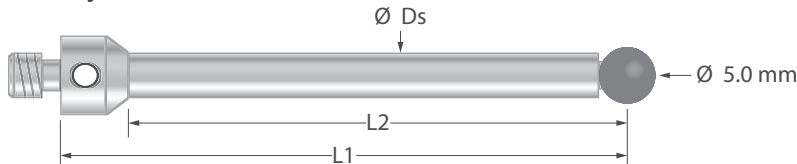

M4 styli with 5.0 mm diameter carbide ball and stainless steel base and stem.

Part Number	L1	L2	Ds	Wt	Price
TM4-5052.5-EC	50.0	44.0	4.5	5.85	\$69.00
TM4-5056.5-EC	54.0	48.0	3.9	6.09	\$158.00
TM4-50102.5-EC	100.0	80.0	4.5	15.52	\$160.00
TM4-50152.5-EC	150.0	130.0	4.5	27.94	\$170.00

M4 probe wrench, golf tee style

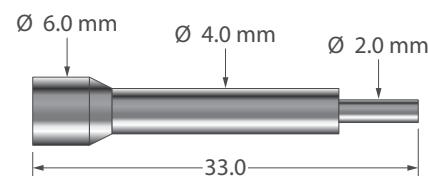

M4 probe key. Made from hardened and tempered tool steel.

Part Number	Wt	Price
PK-4-GT	3.50	\$11.00



WARNING: The products on this page can expose you to chemicals including cobalt, nickel, and phenylhydrazine, which are known to the State of California to cause cancer, and bisphenol A (BPA), which is known to the State of California to cause birth defects or other reproductive harm. For more information go to www.p65warnings.ca.gov.

M4 Threads

M4 thread adapters, stainless steel

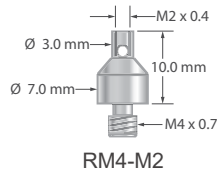

RM4-M2

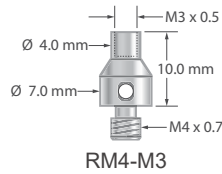

RM4-M3

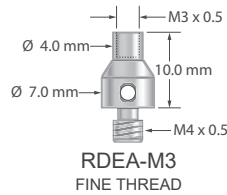

RDEA-M3
FINE THREAD

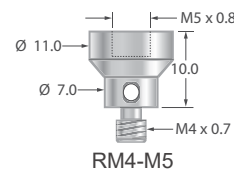

RM4-M5

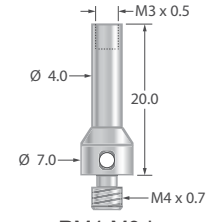

RM4-M3-L

Part Number	Wt	Price
RM4-M2	1.88	\$18.00

Part Number	Wt	Price
RM4-M3	1.72	\$18.00

Part Number	Wt	Price
RDEA-M3	1.71	\$18.00

Part Number	Wt	Price
RM4-M5	4.50	\$18.00

Part Number	Wt	Price
RM4-M3-L	2.71	\$18.00

M4 thread adapters with ceramic body and stainless steel end fittings

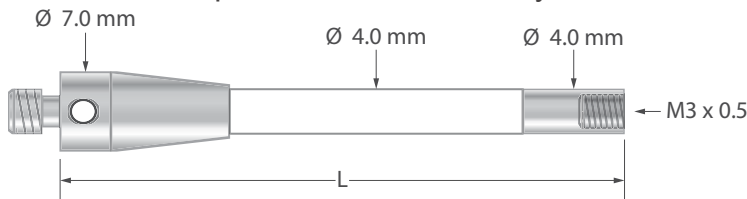

Part Number	L	Wt	Price
RM4-50-M3-C	50.0	4.36	\$59.00
RM4-75-M3-C	75.0	5.18	\$90.00
RM4-100-M3-C	100.0	6.27	\$103.00

M4 thread adapters. Stainless steel end fittings with ceramic body.

M4 weak link

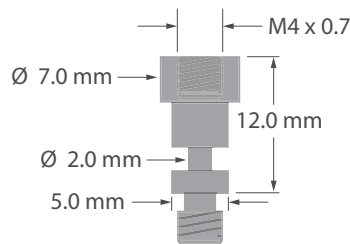

Part Number	Wt	Price
M4-WL	2.26	\$25.00

"Weak Link" with M4 male and M4 female threads. Machined from SAE 4140 chromoly steel. Black oxide finish.

M4 star hub, 5-way

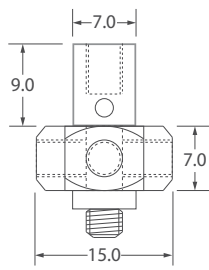

Part Number	Wt	Price
KM4-18	11.63	\$58.00

M4 5-way hub. Fully adjustable, two-piece assembly. Stainless steel.

M4 rotary knuckle



Part Number	Wt	Price
RJM4-33	15.09	\$120.00

M4 rotary knuckle with ball bearing for unlimited radial adjustment and a clevis knuckle for 180 degree axial adjustment. Stainless steel. Overall length is 33.0 mm.



WARNING: The products on this page can expose you to chemicals including cobalt, nickel, and phenylhydrazine, which are known to the State of California to cause cancer, and bisphenol A (BPA), which is known to the State of California to cause birth defects or other reproductive harm. For more information go to www.p65warnings.ca.gov.

M5 Threads

0.2 mm ruby ball with tapered carbide stem

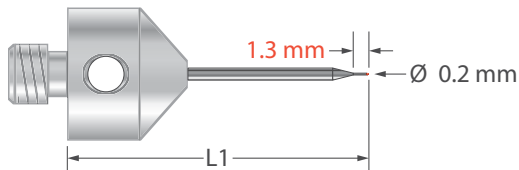

Part Number	L1	Wt	Price
AFG-0225-T	25.0	5.62	\$340.00

M5 stylus with 0.2 mm diameter ruby ball, tapered carbide stem, and 11.0 mm diameter x 10.0 mm long titanium base. Minor stem diameter is 0.15 mm and major diameter is 1.0 mm.

0.3 mm ruby ball with tapered carbide stem

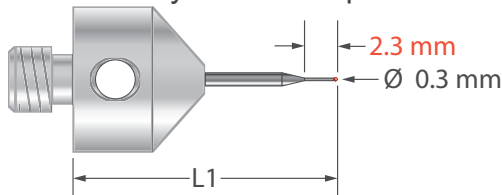

Part Number	L1	Wt	Price
AFG-0318-R	18.0	5.58	\$91.00
AFG-0320-R	20.0	5.65	\$91.00
AFG-0323-R	23.0	5.68	\$99.00

M5 stylus with 0.3 mm diameter ruby ball, tapered carbide stem, and 11.0 mm diameter x 10.0 mm long stainless steel base. Minor stem diameter is 0.2 mm and major diameter is 1.0 mm.

0.3 mm carbide ball with stepped carbide stem

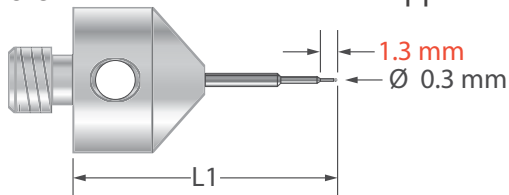

Part Number	L1	Wt	Price
AFG-0320-C	20.0	5.60	\$140.00
AFG-0325-C	25.0	5.65	\$140.00

M5 stylus with 0.3 mm diameter carbide ball, stepped carbide stem, and 11.0 mm diameter x 10.0 mm long stainless steel base. Minor stem diameter is 0.2 mm, intermediate diameter is 0.5 mm, and major diameter is 1.0 mm.

0.4 mm carbide ball with stepped carbide stem

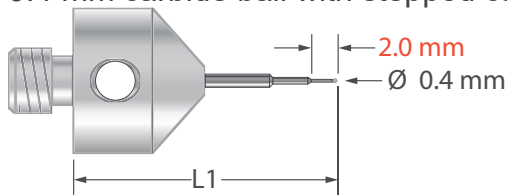

Part Number	L1	Wt	Price
AFG-0420-C	20.0	5.60	\$130.00
AFG-0425-C	25.0	5.65	\$135.00

M5 stylus with 0.4 mm diameter carbide ball, stepped carbide stem, and 11.0 mm diameter x 10.0 mm long stainless steel base. Minor stem diameter is 0.25 mm, intermediate diameter is 0.5 mm, and major diameter is 1.0 mm.

0.5 mm carbide ball with stepped carbide stem

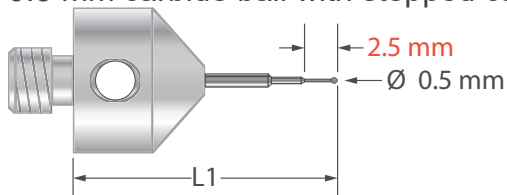

Part Number	L1	Wt	Price
AFG-0520-C	20.0	5.60	\$110.00
AFG-0525-C	25.0	5.66	\$115.00
AFG-0530-C	30.0	5.72	\$121.00
AFG-0540-C	40.0	5.84	\$125.00

M5 stylus with 0.5 mm diameter carbide ball, stepped carbide stem, and 11.0 mm diameter x 10.0 mm long stainless steel base. Minor stem diameter is 0.3 mm, intermediate diameter is 0.5 mm, and major diameter is 1.0 mm.



WARNING: The products on this page can expose you to chemicals including cobalt, nickel, and phenylhydrazine, which are known to the State of California to cause cancer, and bisphenol A (BPA), which is known to the State of California to cause birth defects or other reproductive harm. For more information go to www.p65warnings.ca.gov.

M5 Threads

0.5 mm ruby or silicon nitride ball with tapered carbide stem

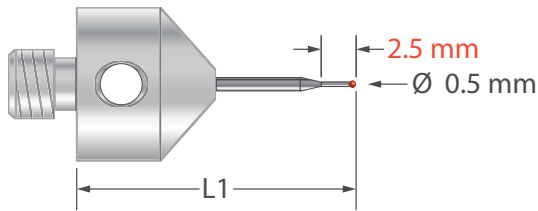

Part Number	L1	Wt	Ruby	Silicon Nitride*
AFG-0515	15.0	5.64	\$98.00	\$128.00
AFG-0520	20.0	5.66	\$98.00	\$128.00
AFG-0522	22.0	5.70	\$98.00	\$128.00
AFG-0525	25.0	5.72	\$110.00	\$140.00
AFG-0530	30.0	5.78	\$121.00	\$151.00
AFG-0540	40.0	5.90	\$125.00	\$155.00
AFG-0550	50.0	6.02	\$130.00	\$160.00
AFG-0555	55.0	6.08	\$175.00	\$205.00

M5 stylus with 0.5 mm diameter ball, tapered carbide stem, and 11.0 mm diameter x 10.0 mm long stainless steel base. Minor stem diameter is 0.3 mm and major diameter is 1.0 mm.

0.6 mm carbide ball with tapered carbide stem

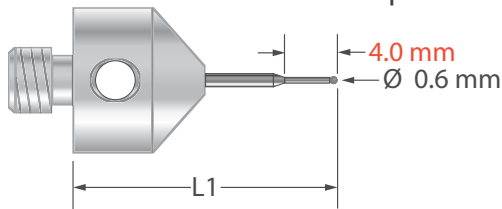

Part Number	L1	Wt	Price
AFG-0620-C	20.0	5.62	\$105.00
AFG-0625-C	25.0	5.68	\$105.00
AFG-0630-C	30.0	5.74	\$110.00

M5 stylus with 0.6 mm diameter carbide ball, tapered carbide stem, and 11.0 mm diameter x 10.0 mm long stainless steel base. Minor stem diameter is 0.43 mm and major diameter is 1.0 mm.

0.6 mm ruby or silicon nitride ball with stepped carbide stem

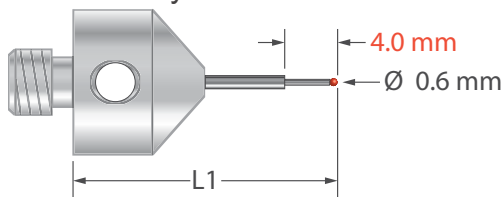

Part Number	L1	Wt	Ruby	Silicon Nitride*
AFG-0620	15.0	5.62	\$95.00	\$125.00
AFG-0622.1	20.0	5.65	\$80.00	\$110.00
AFG-0625	22.0	5.68	\$95.00	\$125.00
AFG-0640	25.0	5.86	\$105.00	\$135.00

M5 stylus with 0.6 mm diameter ball, stepped carbide stem, and 11.0 mm diameter x 10.0 mm long stainless steel base. Minor stem diameter is 0.43 mm and major diameter is 1.0 mm.

0.7 mm ball with 0.5 mm carbide stem

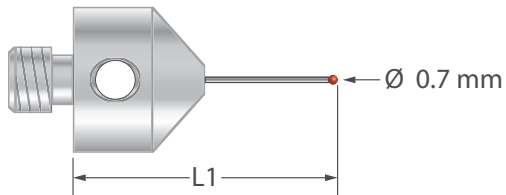

Part Number	L1	Wt	Ruby	Zirconia**
AFG-0720	20.0	5.62	\$68.00	\$98.00
AFG-0730	30.0	5.74	\$72.00	\$102.00

M5 stylus with 0.7 mm diameter ball, 0.5 mm diameter carbide stem, and 11.0 mm diameter x 10.0 mm long stainless steel base.

0.8 mm ball with stepped carbide stem

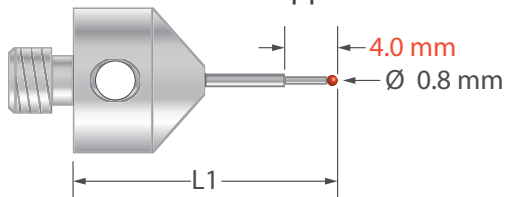

Part Number	L1	Wt	Ruby	Silicon Nitride*	Zirconia**
AFG-0820	20.0	5.65	\$88.00	\$118.00	\$118.00
AFG-0825	25.0	5.71	\$88.00	\$118.00	\$118.00
AFG-0830	30.0	5.77	\$93.00	\$123.00	\$123.00
AFG-0832	32.0	5.79	\$85.00	\$115.00	\$115.00
AFG-0840	40.0	5.89	\$98.00	\$128.00	\$128.00

M5 stylus with 0.8 mm diameter ball, stepped carbide stem, and 11.0 mm diameter x 10.0 mm long stainless steel base. Minor stem diameter is 0.6 mm, major diameter is 1.0 mm.

*NOTE: For a **silicon nitride** ball, add **-SN** to the part number.

NOTE: For a **zirconia ball, add **-Z** to the part number.



WARNING: The products on this page can expose you to chemicals including cobalt, nickel, and phenylhydrazine, which are known to the State of California to cause cancer, and bisphenol A (BPA), which is known to the State of California to cause birth defects or other reproductive harm. For more information go to www.p65warnings.ca.gov.

M5 Threads

0.8 mm ball with stepped carbide stem

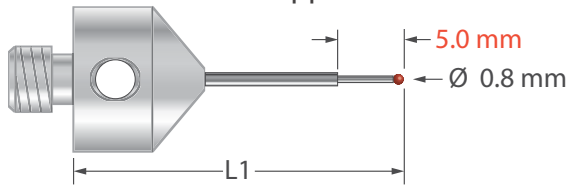

Part Number	L1	Wt	Ruby	Silicon Nitride*	Zirconia**
AFG-0825-L5	25.0	5.51	\$98.00	\$128.00	\$128.00
AFG-0833-L5	33.0	5.60	\$98.00	\$128.00	\$128.00

M5 stylus with 0.8 mm diameter ball, stepped carbide stem, and 11.0 mm diameter x 10.0 mm long stainless steel base. Minor stem diameter is 0.6 mm, major diameter is 1.0 mm.

0.8 mm ball with tapered carbide stem

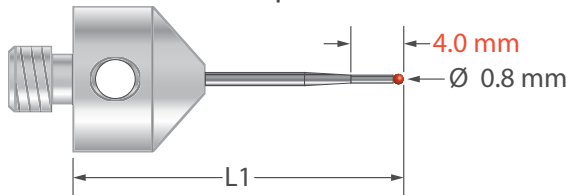

Part Number	L1	Wt	Ruby	Silicon Nitride*	Zirconia**
AFG-0820-T	20.0	5.65	\$88.00	\$118.00	\$118.00
AFG-0825-T	25.0	5.71	\$88.00	\$118.00	\$118.00
AFG-0830-T	30.0	5.77	\$93.00	\$123.00	\$123.00
AFG-0840-T	40.0	5.89	\$98.00	\$128.00	\$123.00

M5 stylus with 0.8 mm diameter ball, tapered carbide stem, and 11.0 mm diameter x 10.0 mm long stainless steel base. Minor stem diameter is 0.6 mm, major diameter is 1.0 mm.

1.0 mm ball with 0.7 mm carbide stem

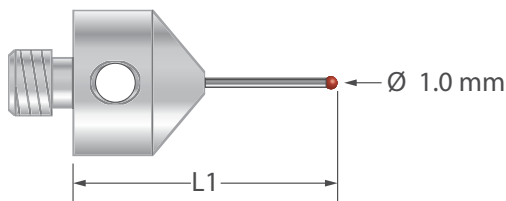

Part Number	L1	Wt	Ruby	Silicon Nitride*	Zirconia**
AFG-1020-DS.7	20.0	5.65	\$70.00	\$100.00	\$100.00
AFG-1020.5-DS.7	20.5	5.68	\$70.00	\$105.00	\$100.00
AFG-1025-DS.7	25.0	5.72	\$70.00	\$100.00	\$100.00
AFG-1030-DS.7	30.0	5.78	\$85.00	\$115.00	\$115.00
AFG-1030.5-DS.7	30.5	5.79	\$80.00	\$110.00	\$110.00
AFG-1040-DS.7	40.0	5.84	\$85.00	\$115.00	\$115.00

M5 stylus with 1.0 mm diameter ball, 0.7 mm diameter carbide stem, and 11.0 mm diameter x 10.0 mm long stainless steel base.

1.0 mm ball with stepped carbide stem

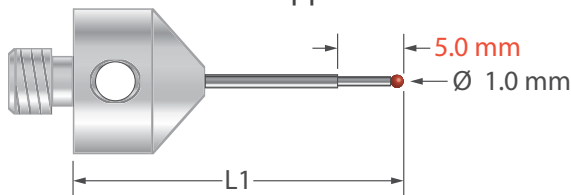

Part Number	L1	Wt	Ruby	Silicon Nitride*	Zirconia**
AFG-1020	20.0	5.65	\$65.00	\$95.00	\$95.00
AFG-1022.5	22.5	5.66	\$65.00	\$95.00	\$95.00
AFG-1025	25.0	5.71	\$65.00	\$95.00	\$95.00

M5 stylus with 1.0 mm diameter ball, stepped carbide stem, and 11.0 mm diameter x 10.0 mm long stainless steel base. Minor stem diameter is 0.7 mm, major diameter is 1.0 mm.

1.0 mm ball with tapered carbide stem

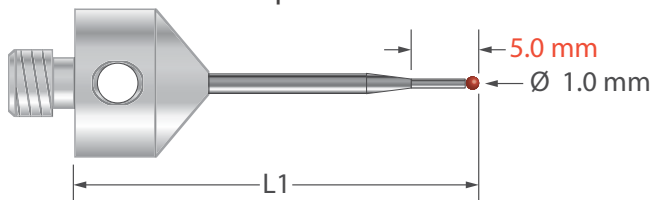

Part Number	L1	Wt	Ruby	Silicon Nitride*	Zirconia**
AFG-1030	30.0	5.77	\$80.00	\$105.00	\$105.00
AFG-1040	35.0	5.89	\$80.00	\$110.00	\$110.00
AFG-1058	58.0	6.09	\$80.00	\$110.00	\$110.00
AFG-1080	60.0	6.33	\$85.00	\$120.00	\$120.00

M5 stylus with 1.0 mm diameter ball, tapered carbide stem, and 11.0 mm diameter x 10.0 mm long hard anodized aluminum base. Minor stem diameter is 0.7 mm, major diameter is 1.5 mm.

*NOTE: For a **silicon nitride** ball, add **-SN** to the part number.

NOTE: For a **zirconia ball, add **-Z** to the part number.



WARNING: The products on this page can expose you to chemicals including cobalt, nickel, and phenylhydrazine, which are known to the State of California to cause cancer, and bisphenol A (BPA), which is known to the State of California to cause birth defects or other reproductive harm. For more information go to www.p65warnings.ca.gov.

M5 Threads

1.0 mm ball with stepped carbide stem and light weight design

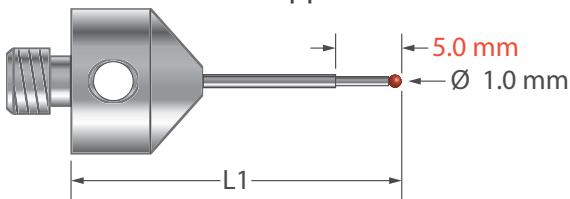

Part Number	L1	Wt	Ruby	Silicon Nitride*	Zirconia**
AFG-1020-L	20.0	2.08	\$70.00	\$100.00	\$100.00
AFG-1025-L	25.0	2.10	\$70.00	\$100.00	\$100.00

M5 stylus with 1.0 mm diameter ball, stepped carbide stem, and 11.0 mm diameter x 10.0 mm long hard anodized aluminum base. Minor stem diameter is 0.7 mm, major diameter is 1.0 mm.

1.0 mm ball with tapered carbide stem and light weight design

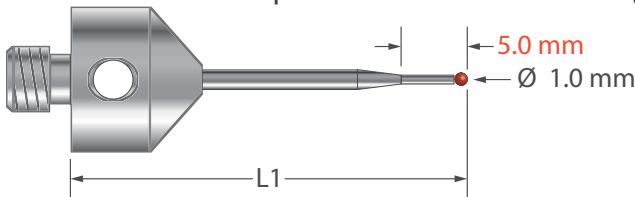

Part Number	L1	Wt	Ruby	Silicon Nitride*	Zirconia**
AFG-1030-L	30.0	2.14	\$80.00	\$110.00	\$110.00
AFG-1035-L	35.0	2.20	\$80.00	\$110.00	\$110.00
AFG-1060-L	60.0	2.48	\$85.00	\$115.00	\$115.00

M5 stylus with 1.0 mm diameter ball, tapered carbide stem, and 11.0 mm diameter x 10.0 mm long hard anodized aluminum base. Minor stem diameter is 0.7 mm, major diameter is 1.5 mm.

1.35 mm ball with 1.0 mm carbide stem

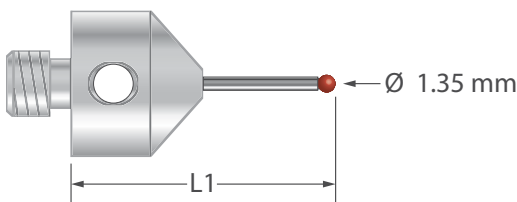

Part Number	L1	Wt	Ruby	Silicon Nitride*
AFG-1320	20.0	5.63	\$60.00	\$90.00
AFG-1325	25.0	5.69	\$60.00	\$90.00
AFG-1330	30.0	5.75	\$60.00	\$90.00
AFG-1332	32.0	5.77	\$60.00	\$90.00
AFG-1333	33.0	5.78	\$60.00	\$90.00
AFG-1335	35.0	5.81	\$60.00	\$90.00
AFG-1340	40.0	5.87	\$60.00	\$90.00
AFG-1344	44.0	5.93	\$60.00	\$90.00
AFG-1346	46.0	6.03	\$70.00	\$100.00

M5 stylus with 1.35 mm diameter ball, 1.0 mm diameter carbide stem, and 11.0 mm diameter x 10.0 mm long stainless steel base.

1.35 mm ball with 1.0 mm carbide stem, light weight design

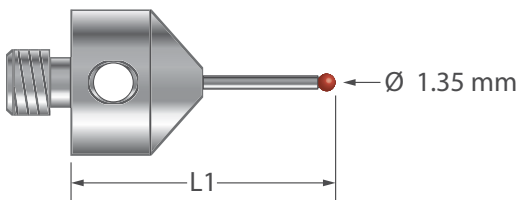

Part Number	L1	Wt	Ruby
AFG-1325-L	25.0	2.12	\$65.00
AFG-1340-L	40.0	2.30	\$65.00
AFG-1346-L	46.0	2.46	\$75.00

M5 stylus with 1.35 mm diameter ball, 1.0 mm diameter carbide stem, and 11.0 mm diameter x 10.0 mm long hard anodized aluminum base.

1.35 mm ball with 1.0 mm carbide stem and 9.0 mm long base

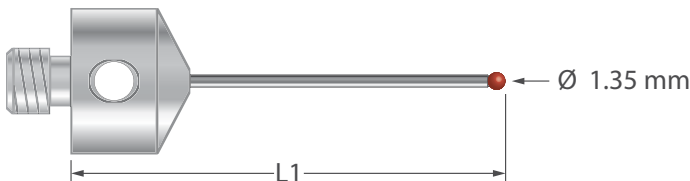

Part Number	L1	Wt	Ruby
AFG-1332.85-DS1	32.85	5.77	\$78.00

M5 stylus with 1.35 mm diameter ball, 1.0 mm diameter carbide stem, and 11.0 mm diameter x 9.0 mm long stainless steel base.

*NOTE: For a **silicon nitride** ball, add **-SN** to the part number.

NOTE: For a **zirconia ball, add **-Z** to the part number.



WARNING: The products on this page can expose you to chemicals including cobalt, nickel, and phenylhydrazine, which are known to the State of California to cause cancer, and bisphenol A (BPA), which is known to the State of California to cause birth defects or other reproductive harm. For more information go to www.p65warnings.ca.gov.

M5 Threads

1.5 mm ball with 0.7 mm carbide stem

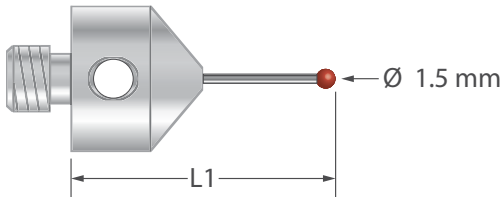

Part Number	L1	Wt	Ruby	Silicon Nitride*	Zirconia**
AFG-1520-DS.7	20.0	5.59	\$70.00	\$100.00	\$100.00

M5 stylus with 1.5 mm diameter ball, 0.7 mm diameter carbide stem, and 11.0 mm diameter x 10.0 mm long stainless steel base.

1.5 mm ball with 1.0 mm carbide stem

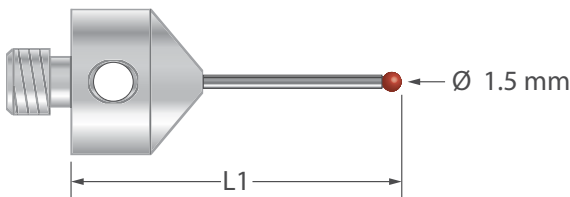

Part Number	L1	Wt	Ruby	Silicon Nitride*	Zirconia**
AFG-1515	15.0	5.57	\$65.00	\$95.00	\$95.00
AFG-1520	20.0	5.63	\$65.00	\$95.00	\$95.00
AFG-1520.75	20.75	5.64	\$70.00	\$100.00	\$100.00
AFG-1525	25.0	5.69	\$65.00	\$95.00	\$95.00
AFG-1530-DS1	30.0	5.75	\$65.00	\$95.00	\$95.00
AFG-1533-DS1	33.0	5.78	\$49.00	\$79.00	\$79.00
AFG-1535-DS1	35.0	5.80	\$65.00	\$95.00	\$95.00
AFG-1540-DS1	40.0	5.86	\$63.00	\$93.00	\$93.00
AFG-1540.75-DS1	40.75	5.93	\$70.00	\$100.00	\$100.00
AFG-1545-DS1	45.0	6.04	\$70.00	\$100.00	\$100.00

M5 stylus with 1.5 mm diameter ball, 1.0 mm diameter carbide stem, and 11.0 mm diameter x 10.0 mm long stainless steel base.

1.5 mm ball with stepped carbide stem

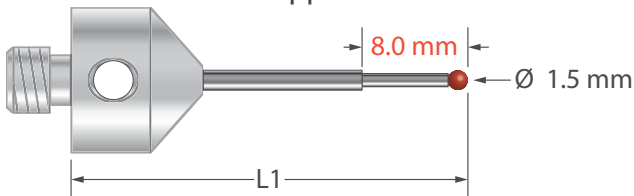

Part Number	L1	Wt	Ruby	Silicon Nitride*	Zirconia**
AFG-1530	30.0	6.05	\$65.00	\$95.00	\$95.00
AFG-1535	35.0	6.17	\$65.00	\$95.00	\$95.00
AFG-1540	40.0	6.29	\$70.00	\$100.00	\$100.00
AFG-1545	45.0	6.41	\$70.00	\$100.00	\$100.00
AFG-1550	50.0	6.53	\$70.00	\$100.00	\$100.00

M5 stylus with 1.5 mm diameter ball, stepped carbide stem, and 11.0 mm diameter x 10.0 mm long stainless steel base. Minor stem diameter is 1.0 mm, major diameter is 1.5 mm.

1.5 mm ball with 1.0 mm carbide stem, light weight design

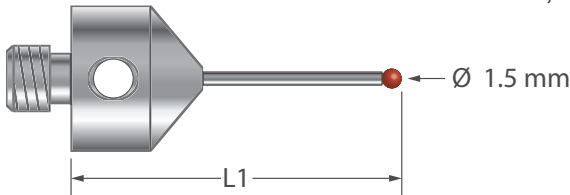

Part Number	L1	Wt	Ruby	Silicon Nitride*	Zirconia**
AFG-1515-L	15.0	2.00	\$70.00	\$100.00	\$100.00
AFG-1520-L	20.0	2.06	\$70.00	\$100.00	\$100.00
AFG-1525-L	25.0	2.12	\$70.00	\$100.00	\$100.00

M5 stylus with 1.5 mm diameter ball, 1.0 mm diameter carbide stem, and 11.0 mm diameter x 10.0 mm long hard anodized aluminum base.

1.5 mm ball with stepped carbide stem, light weight design

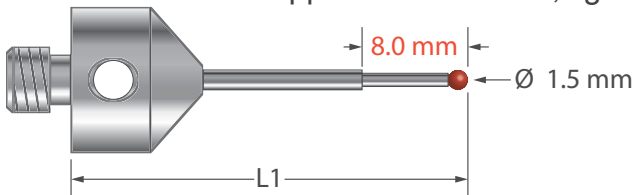

Part Number	L1	Wt	Ruby	Silicon Nitride*	Zirconia**
AFG-1530-L	30.0	2.42	\$70.00	\$100.00	\$100.00

M5 stylus with 1.5 mm diameter ball, stepped carbide stem, and 11.0 mm diameter x 10.0 mm hard anodized aluminum base. Minor stem diameter is 1.0 mm, major diameter is 1.5 mm.

*NOTE: For a **silicon nitride** ball, add **-SN** to the part number.

NOTE: For a **zirconia ball, add **-Z** to the part number.

WARNING: The products on this page can expose you to chemicals including cobalt, nickel, and phenylhydrazine, which are known to the State of California to cause cancer, and bisphenol A (BPA), which is known to the State of California to cause birth defects or other reproductive harm. For more information go to www.p65warnings.ca.gov.

M5 Threads

2.0 mm ball with 1.0 mm carbide stem

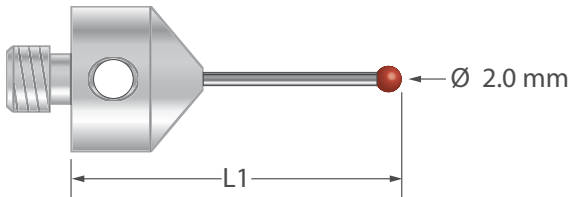

Part Number	L1	Wt	Ruby	Silicon Nitride*	Zirconia**
AFG-2020	20.0	5.60	\$57.00	\$87.00	\$87.00
AFG-2021	21.0	5.61	\$55.00	\$85.00	\$85.00
AFG-2025	25.0	5.66	\$57.00	\$87.00	\$87.00
AFG-2031-DS1	31.0	5.72	\$64.00	\$94.00	\$94.00
AFG-2041-DS1	41.0	5.83	\$80.00	\$110.00	\$110.00
AFG-2051-DS1	51.0	5.96	\$89.00	\$119.00	\$119.00

M5 stylus with 2.0 mm diameter ball, 1.0 mm diameter carbide stem, and 11.0 mm diameter x 10.0 mm long stainless steel base.

2.0 mm ball with 1.5 mm carbide stem

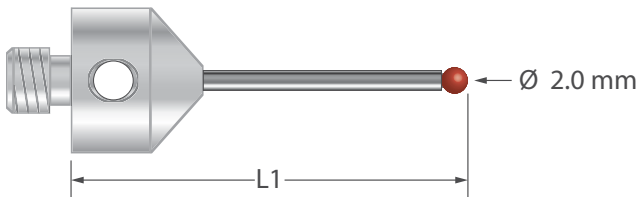

Part Number	L1	Wt	Ruby	Silicon Nitride*	Zirconia**
AFG-2030	30.0	6.08	\$75.00	\$105.00	\$105.00
AFG-2033.5	33.5	6.17	\$80.00	\$70.00	\$110.00
AFG-2035	35.0	6.20	\$64.00	\$94.00	\$94.00
AFG-2040	40.0	6.32	\$85.00	\$115.00	\$115.00
AFG-2045	45.0	6.45	\$69.00	\$99.00	\$99.00
AFG-2050	50.0	6.57	\$90.00	\$120.00	\$120.00
AFG-2060	60.0	6.82	\$95.00	\$125.00	\$125.00
AFG-2080	80.0	7.32	\$83.00	\$113.00	\$113.00
AFG-2081	81.0	7.34	\$83.00	\$113.00	\$113.00
AFG-20100	100.0	7.81	\$88.00	\$118.00	\$118.00

M5 stylus with 2.0 mm diameter ball, 1.5 mm diameter carbide stem, and 11.0 mm diameter x 10.0 mm long stainless steel base.

2.0 mm ball with 1.0 mm carbide stem, light weight design

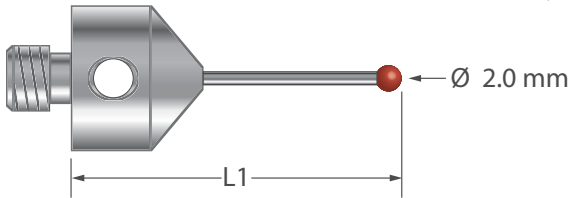

Part Number	L1	Wt	Ruby	Silicon Nitride*	Zirconia**
AFG-2020-L	20.0	2.06	\$62.00	\$92.00	\$92.00
AFG-2025-L	25.0	2.12	\$62.00	\$92.00	\$92.00

M5 stylus with 2.0 mm diameter ball, 1.0 mm diameter carbide stem, and 11.0 mm diameter x 10.0 mm long hard anodized aluminum base.

2.0 mm ball with 1.5 mm carbide stem, light weight design

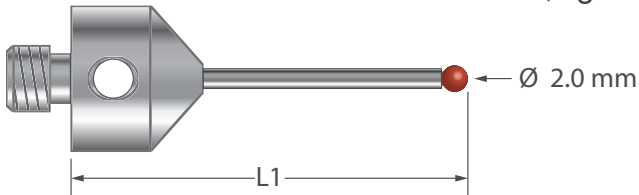

Part Number	L1	Wt	Ruby	Silicon Nitride*	Zirconia**
AFG-2030-L	30.0	2.39	\$69.00	\$99.00	\$99.00
AFG-2035-L	35.0	2.51	\$69.00	\$99.00	\$99.00
AFG-2040-L	40.0	2.63	\$71.00	\$101.00	\$101.00

M5 stylus with 2.0 mm diameter ball, 1.5 mm diameter carbide stem, and 11.0 mm diameter x 10.0 mm long hard anodized aluminum base.

2.5 mm ball with 1.5 mm carbide stem, light weight design

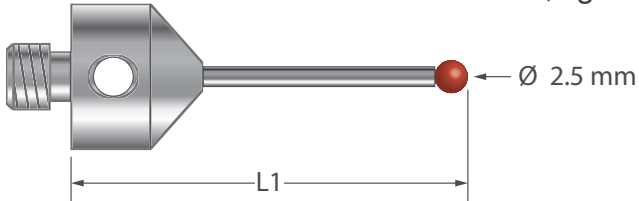

Part Number	L1	Wt	Ruby	Silicon Nitride*	Zirconia**
AFG-2520-L	20.0	2.18	\$71.00	\$101.00	\$101.00
AFG-2525-L	25.0	2.30	\$71.00	\$101.00	\$101.00
AFG-2530-L	30.0	2.42	\$71.00	\$101.00	\$101.00
AFG-2535-L	35.0	2.74	\$71.00	\$101.00	\$101.00
AFG-2540-L	40.0	2.88	\$77.00	\$107.00	\$107.00

M5 stylus with 2.5 mm diameter ball, 1.5 mm diameter carbide stem, and 11.0 mm diameter x 10.0 mm long hard anodized aluminum base.

*NOTE: For a **silicon nitride** ball, add **-SN** to the part number.

NOTE: For a **zirconia ball, add **-Z** to the part number.



WARNING: The products on this page can expose you to chemicals including cobalt, nickel, and phenylhydrazine, which are known to the State of California to cause cancer, and bisphenol A (BPA), which is known to the State of California to cause birth defects or other reproductive harm. For more information go to www.p65warnings.ca.gov.

M5 Threads

2.5 mm ball with 1.5 mm carbide stem

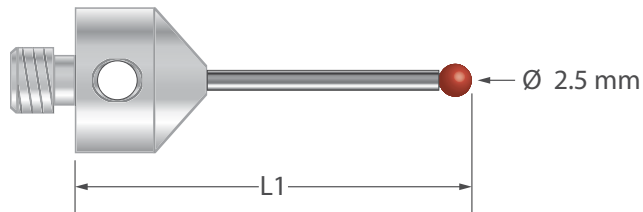

Part Number	L1	Wt	Ruby	Silicon Nitride*	Zirconia**
AFG-2520	20.0	5.75	\$66.00	\$96.00	\$96.00
AFG-2521.25	21.25	5.77	\$60.00	\$90.00	\$90.00
AFG-2525	25.0	5.87	\$66.00	\$96.00	\$96.00
AFG-2530	30.0	5.99	\$66.00	\$96.00	\$96.00
AFG-2531.25	31.25	6.02	\$66.00	\$96.00	\$96.00
AFG-2534	34.0	6.26	\$54.00	\$84.00	\$84.00
AFG-2535	35.0	6.31	\$66.00	\$96.00	\$96.00
AFG-2540	40.0	6.45	\$72.00	\$102.00	\$102.00
AFG-2550	50.0	6.74	\$74.00	\$104.00	\$104.00
AFG-2565	65.0	6.85	\$77.00	\$107.00	\$107.00
AFG-2575	75.0	7.10	\$80.00	\$110.00	\$110.00

M5 stylus with 2.5 mm diameter ball, 1.5 mm diameter carbide stem, and 11.0 mm diameter x 10.0 mm long stainless steel base.

3.0 mm ball with 1.5 mm carbide stem

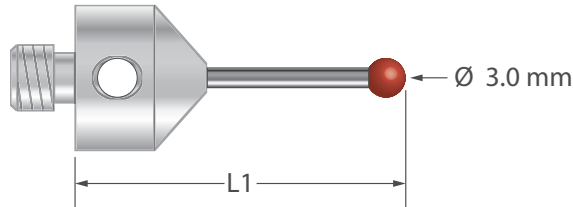

Part Number	L1	Wt	Ruby	Silicon Nitride*	Zirconia**
ATG-3015	15.0	5.63	\$60.00	\$90.00	\$90.00
ATG-3020	20.0	5.91	\$60.00	\$90.00	\$90.00
ATG-3025	25.0	6.01	\$60.00	\$90.00	\$90.00

M5 stylus with 3.0 mm diameter ball, 1.5 mm diameter carbide stem, and 11.0 mm diameter x 10.0 mm long stainless steel base.

3.0 mm ball with 2.0 mm carbide stem

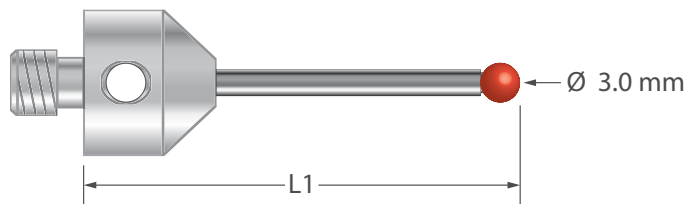

Part Number	L1	Wt	Ruby	Silicon Nitride*	Zirconia**
ATG-3021.5	21.5	5.91	\$49.00	\$79.00	\$79.00
ATG-3025-DS2	25.0	6.37	\$50.00	\$80.00	\$80.00
ATG-3030	30.0	6.61	\$62.00	\$92.00	\$92.00
ATG-3033	33.0	6.75	\$58.00	\$87.00	\$87.00
ATG-3033.5	33.5	6.78	\$41.00	\$87.00	\$87.00
ATG-3035	35.0	6.84	\$66.00	\$96.00	\$96.00
ATG-3040	40.0	7.06	\$68.00	\$98.00	\$98.00
ATG-3041.5	41.5	7.18	\$68.00	\$98.00	\$98.00
ATG-3045	45.0	7.28	\$68.00	\$98.00	\$98.00
ATG-3050	50.0	7.50	\$59.00	\$80.00	\$80.00
ATG-3051.5	51.5	7.62	\$70.00	\$100.00	\$100.00
ATG-3058	58.0	7.86	\$40.00	\$84.00	\$82.00
ATG-3060	60.0	7.95	\$74.00	\$100.00	\$100.00
ATG-3063	63.0	8.08	\$70.00	\$100.00	\$100.00
ATG-3065	65.0	8.17	\$72.00	\$102.00	\$102.00
ATG-3070	70.0	8.40	\$72.00	\$102.00	\$102.00
ATG-3075	75.0	8.62	\$74.00	\$104.00	\$104.00
ATG-3080	80.0	8.84	\$74.00	\$104.00	\$104.00
ATG-3085	85.0	9.07	\$74.00	\$104.00	\$104.00
ATG-3090	90.0	9.29	\$76.00	\$110.00	\$106.00
ATG-30100	100.0	9.73	\$88.00	\$118.00	\$118.00
ATG-30110	110.0	10.18	\$88.00	\$118.00	\$118.00
ATG-30118	118.0	10.54	\$88.00	\$118.00	\$118.00
ATG-30120	120.0	10.63	\$88.00	\$118.00	\$118.00

M5 stylus with 3.0 mm diameter ball, 2.0 mm diameter carbide stem, and 11.0 mm diameter x 10.0 mm long stainless steel base.



WARNING: The products on this page can expose you to chemicals including cobalt, nickel, and phenylhydrazine, which are known to the State of California to cause cancer, and bisphenol A (BPA), which is known to the State of California to cause birth defects or other reproductive harm. For more information go to www.p65warnings.ca.gov.

M5 Threads

3.0 mm ball with 1.5 mm carbide stem, light weight design

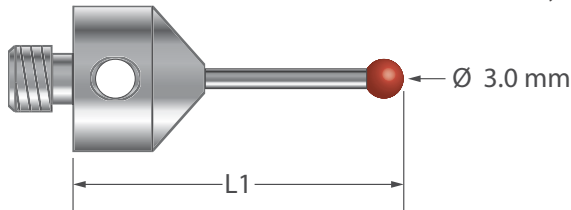

Part Number	L1	Wt	Ruby	Silicon Nitride*	Zirconia**
ATG-3020-L	20.0	2.21	\$65.00	\$95.00	\$95.00
ATG-3025-L	25.0	2.43	\$67.00	\$97.00	\$97.00

M5 stylus with 3.0 mm diameter ball, 1.5 mm diameter carbide stem, and 11.0 mm diameter x 10.0 mm long hard anodized aluminum base.

3.0 mm ball with 2.0 mm carbide stem, light weight design

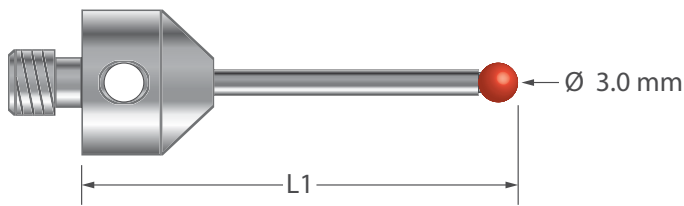

Part Number	L1	Wt	Ruby	Silicon Nitride*	Zirconia**
ATG-3030-L	30.0	2.88	\$67.00	\$97.00	\$97.00
ATG-3033-L	33.0	3.02	\$71.00	\$101.00	\$101.00
ATG-3050-L	50.0	3.78	\$73.00	\$103.00	\$103.00
ATG-3058-L	58.0	4.14	\$75.00	\$105.00	\$105.00
ATG-3065-L	65.0	4.45	\$77.00	\$107.00	\$107.00
ATG-3080-L	80.0	5.12	\$79.00	\$109.00	\$109.00

M5 stylus with 3.0 mm diameter ball, 2.0 mm diameter carbide stem, and 11.0 mm diameter x 10.0 mm long hard anodized aluminum base.

3.0 mm ball with 2.0 mm carbon fiber stem and titanium base, Therm-X design

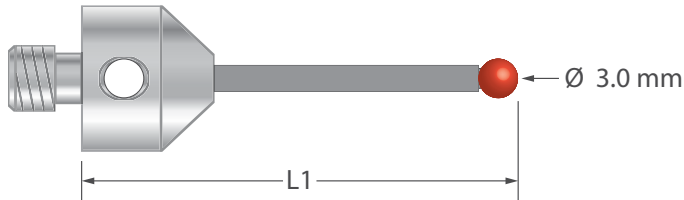

Part Number	L1	Wt	Ruby	Silicon Nitride*	Zirconia**
ATG-3025-TX	30.0	3.34	\$78.00	\$108.00	\$108.00
ATG-3033-TX	33.0	3.37	\$85.00	\$115.00	\$115.00
ATG-3050-TX	50.0	3.45	\$98.00	\$128.00	\$128.00
ATG-3058-TX	58.0	3.49	\$98.00	\$128.00	\$128.00

M5 stylus with 3.0 mm diameter ball, 2.0 mm diameter Therm-X carbon fiber stem, and 11.0 mm diameter x 10.0 mm long titanium base.

3.0 mm diamond sphere with 2.0 mm carbide stem

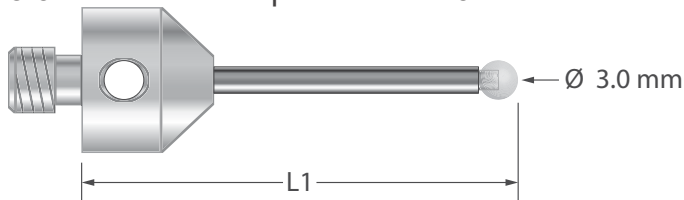

Part Number	L1	Wt	Price
ATG-3033-D	33.0	6.75	\$1,070.00
ATG-3058-D	58.0	7.86	\$1,070.00
ATG-3075-D	75.0	8.62	\$1,070.00

M5 stylus with 3.0 mm diameter diamond sphere, 2.0 mm diameter carbide stem, and 11.0 mm diameter x 10.0 mm long stainless steel base.

3.05 mm diamond coated sphere with 2.0 mm carbide stem



Part Number	L1	Wt	Price
ATG-3033-DC	33.0	6.75	\$695.00
ATG-3058-DC	58.0	7.86	\$695.00
ATG-3075-DC	75.0	8.62	\$695.00

M5 stylus with 3.05 mm diameter diamond coated sphere, 2.0 mm diameter carbide stem, and 11.0 mm diameter x 10.0 mm long stainless steel base.

*NOTE: For a **silicon nitride** ball, add **-SN** to the part number.

NOTE: For a **zirconia ball, add **-Z** to the part number.

WARNING: The products on this page can expose you to chemicals including cobalt, nickel, and phenylhydrazine, which are known to the State of California to cause cancer, and bisphenol A (BPA), which is known to the State of California to cause birth defects or other reproductive harm. For more information go to www.p65warnings.ca.gov.

M5 Threads

3.5 mm ball with 2.5 mm carbide stem

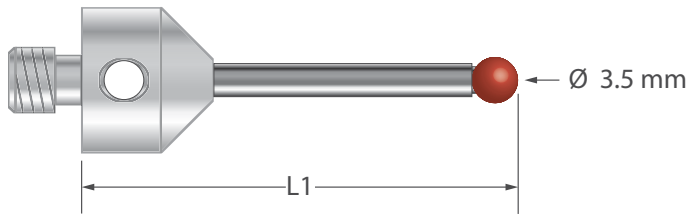

Part Number	L1	Wt	Ruby	Silicon Nitride*	Zirconia**
ATG-3518	18.0	6.14	\$66.00	\$96.00	\$96.00
ATG-3530	30.0	6.96	\$68.00	\$98.00	\$98.00
ATG-3533	33.0	7.16	\$68.00	\$98.00	\$98.00
ATG-3535	35.0	7.30	\$68.00	\$98.00	\$98.00
ATG-3545	45.0	7.98	\$68.00	\$98.00	\$98.00
ATG-3550	50.0	8.32	\$70.00	\$100.00	\$100.00
ATG-3555	55.0	8.66	\$70.00	\$100.00	\$100.00
ATG-3558	58.0	8.86	\$70.00	\$100.00	\$100.00
ATG-3560	60.0	9.00	\$70.00	\$100.00	\$100.00
ATG-3575	75.0	10.02	\$74.00	\$104.00	\$104.00
ATG-3580	80.0	10.36	\$76.00	\$106.00	\$106.00
ATG-3590	90.0	11.04	\$78.00	\$108.00	\$108.00
ATG-35100	100.0	11.72	\$85.00	\$115.00	\$115.00

M5 stylus with 3.5 mm diameter ball, 2.5 mm diameter carbide stem, and 11.0 mm diameter x 10.0 mm long stainless steel base.

4.0 mm ball with 2.0 mm carbide stem

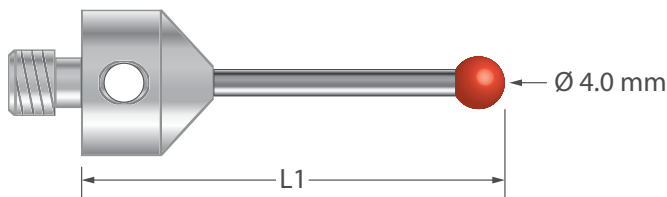

Part Number	L1	Wt	Ruby	Silicon Nitride*	Zirconia**
ATG-4022	22.0	5.91	\$63.00	\$93.00	\$93.00
ATG-4025	25.0	6.42	\$63.00	\$93.00	\$93.00
ATG-4030	30.0	6.64	\$63.00	\$93.00	\$93.00
ATG-4032	32.0	6.72	\$63.00	\$93.00	\$93.00
ATG-4033	33.0	6.77	\$63.00	\$93.00	\$93.00
ATG-4033.5	33.5	6.80	\$53.00	\$83.00	\$83.00
ATG-4035	35.0	6.86	\$63.00	\$93.00	\$93.00
ATG-4040	40.0	7.08	\$68.00	\$98.00	\$98.00
ATG-4052	52.0	7.67	\$70.00	\$100.00	\$100.00

M5 stylus with 4.0 mm diameter ball, 2.0 mm diameter carbide stem, and 11.0 mm diameter x 10.0 mm long stainless steel base.

4.0 mm ball with 2.5 mm carbide stem

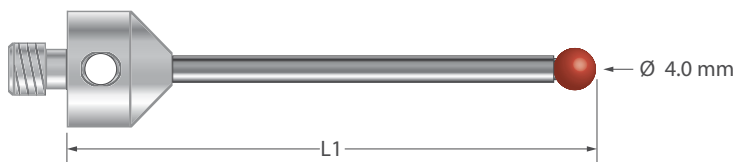

Part Number	L1	Wt	Ruby	Silicon Nitride*	Zirconia**
ATG-4050	50.0	8.34	\$80.00	\$110.00	\$110.00
ATG-4055	55.0	8.68	\$80.00	\$110.00	\$110.00
ATG-4058	58.0	8.88	\$80.00	\$110.00	\$110.00
ATG-4060	60.0	9.02	\$80.00	\$110.00	\$110.00
ATG-4064	64.0	9.29	\$80.00	\$110.00	\$110.00
ATG-4070	70.0	9.70	\$80.00	\$110.00	\$110.00
ATG-4075	75.0	10.04	\$85.00	\$115.00	\$115.00
ATG-4080	80.0	10.38	\$90.00	\$120.00	\$120.00
ATG-4085	85.0	10.72	\$95.00	\$125.00	\$125.00
ATG-4090	90.0	11.06	\$95.00	\$125.00	\$125.00
ATG-4095	95.0	11.40	\$95.00	\$125.00	\$125.00
ATG-40100	100.0	11.74	\$110.00	\$140.00	\$140.00
ATG-40110	110.0	12.42	\$120.00	\$150.00	\$150.00
ATG-40120	120.0	13.10	\$120.00	\$150.00	\$150.00

M5 stylus with 4.0 mm diameter ball, 2.5 mm diameter carbide stem, and 11.0 mm diameter x 10.0 mm long stainless steel base.

4.0 mm ball with 3.0 mm carbide stem

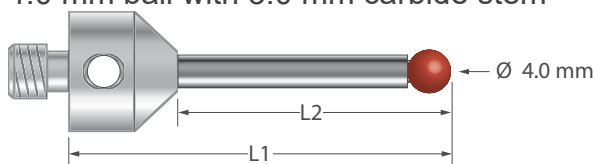

Part Number	L1	L2	Wt	Ruby	Silicon Nitride*	Zirconia**
ATG-4077-DS3	77.0	67.0	11.44	\$100.00	\$130.00	\$130.00
ATG-40135	135.0	125.0	18.32	\$115.00	\$145.00	\$145.00
ATG-40150	150.0	135.0	21.14	\$120.00	\$150.00	\$150.00

M5 stylus with 4.0 mm diameter ball, 3.0 mm diameter carbide stem, and 11.0 mm diameter stainless steel base.



WARNING: The products on this page can expose you to chemicals including cobalt, nickel, and phenylhydrazine, which are known to the State of California to cause cancer, and bisphenol A (BPA), which is known to the State of California to cause birth defects or other reproductive harm. For more information go to www.p65warnings.ca.gov.

M5 Threads

4.0 mm ball with 2.0 mm carbon fiber stem and titanium base, Therm-X design



Part Number	L1	Wt	Ruby	Silicon Nitride*	Zirconia**
ATG-4033-TX	33.0	3.45	\$103.00	\$133.00	\$133.00
ATG-4064-TX	64.0	3.60	\$115.00	\$145.00	\$145.00

M5 stylus with 4.0 mm diameter ball, 2.0 mm diameter Therm-X carbon fiber stem, and 11.0 mm diameter x 10.0 mm long titanium base.

5.0 mm ball with 2.5 mm carbide stem

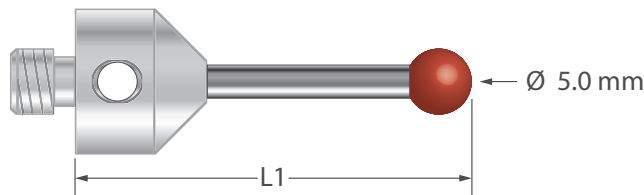

Part Number	L1	Wt	Ruby	Silicon Nitride*	Zirconia**
ATG-5015	15.0	6.35	\$80.00	\$110.00	\$110.00
ATG-5020	20.0	6.69	\$80.00	\$110.00	\$110.00
ATG-5022.5	22.5	6.86	\$80.00	\$110.00	\$110.00
ATG-5030	30.0	7.37	\$80.00	\$110.00	\$110.00
ATG-5033	33.0	7.57	\$80.00	\$110.00	\$110.00
ATG-5035	35.0	7.71	\$80.00	\$110.00	\$110.00
ATG-5040	40.0	8.05	\$80.00	\$110.00	\$110.00

M5 stylus with 5.0 mm diameter ball, 2.5 mm diameter carbide stem, and 11.0 mm diameter x 10.0 mm long stainless steel base.

5.0 mm ball with 3.5 mm carbide stem

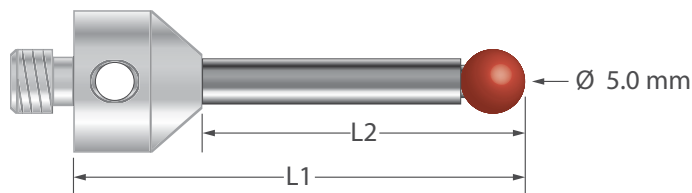

Part Number	L1	L2	Wt	Ruby	Silicon Nitride*	Zirconia**
ATG-5045	45.0	35.0	10.48	\$80.00	\$110.00	\$110.00
ATG-5050	50.0	40.0	11.18	\$45.00	\$95.00	\$95.00
ATG-5053	53.0	43.0	11.59	\$64.00	\$100.00	\$100.00
ATG-5058	58.0	48.0	12.28	\$75.00	\$105.00	\$105.00
ATG-5060	60.0	50.0	12.56	\$75.00	\$105.00	\$105.00
ATG-5063	63.0	53.0	12.70	\$75.00	\$105.00	\$105.00
ATG-5065	65.0	55.0	12.97	\$90.00	\$120.00	\$120.00
ATG-5070	70.0	60.0	13.67	\$90.00	\$120.00	\$120.00
ATG-5075	75.0	65.0	14.36	\$50.00	\$120.00	\$120.00
ATG-5080	80.0	70.0	15.05	\$90.00	\$120.00	\$120.00
ATG-5085	85.0	75.0	15.74	\$90.00	\$120.00	\$120.00
ATG-5090	90.0	80.0	16.43	\$90.00	\$120.00	\$120.00
ATG-50100	100.0	90.0	17.82	\$110.00	\$140.00	\$140.00
ATG-50105	105.0	95.0	18.51	\$94.00	\$124.00	\$124.00
ATG-50114	114.0	104.0	19.75	\$110.00	\$140.00	\$140.00
ATG-50120	120.0	110.0	20.58	\$110.00	\$140.00	\$140.00
ATG-50125	125.0	110.0	21.27	\$120.00	\$150.00	\$150.00
ATG-50130	130.0	115.0	23.80	\$125.00	\$155.00	\$155.00
ATG-50135	135.0	120.0	24.49	\$125.00	\$155.00	\$155.00
ATG-50140	140.0	125.0	25.18	\$135.00	\$165.00	\$165.00

M5 stylus with 5.0 mm diameter ball, 3.5 mm diameter carbide stem, and 11.0 mm diameter stainless steel base.

5.0 mm ball with 3.0 mm carbide stem

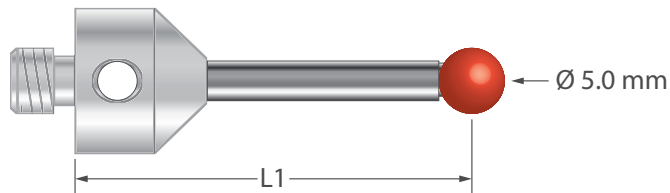

Part Number	L1	Wt	Ruby	Silicon Nitride*	Zirconia**
ATG-5032.5	30.0	6.88	\$80.00	\$110.00	\$110.00
ATG-5052.5	50.0	8.87	\$80.00	\$110.00	\$110.00
ATG-5077.5-DS3	75.0	11.63	\$84.00	\$114.00	\$114.00

M5 stylus with 5.0 mm diameter ball, 3.0 mm diameter carbide stem, and 11.0 mm diameter x 10.0 mm long stainless steel base.

*NOTE: For a silicon nitride ball, add -SN to the part number.

**NOTE: For a zirconia ball, add -Z to the part number.



WARNING: The products on this page can expose you to chemicals including cobalt, nickel, and phenylhydrazine, which are known to the State of California to cause cancer, and bisphenol A (BPA), which is known to the State of California to cause birth defects or other reproductive harm. For more information go to www.p65warnings.ca.gov.

M5 Threads

5.0 mm ball with 3.5 mm ceramic stem

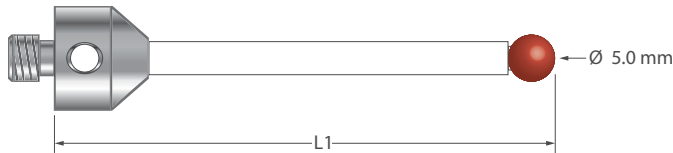

Part Number	L1	Wt	Ruby	Silicon Nitride*	Zirconia**
ATG-5053-C	53.0	3.38	\$68.00	\$98.00	\$98.00
ATG-5063-C	63.0	4.12	\$85.00	\$115.00	\$115.00
ATG-50100-C	100.0	5.49	\$99.00	\$129.00	\$129.00

M5 stylus with 5.0 mm diameter ball, 3.5 mm diameter ceramic stem, and 11.0 mm diameter x 10.0 mm long hard anodized aluminum base.

5.0 mm ball with 3.5 mm carbon fiber stem and titanium base, Therm-X design

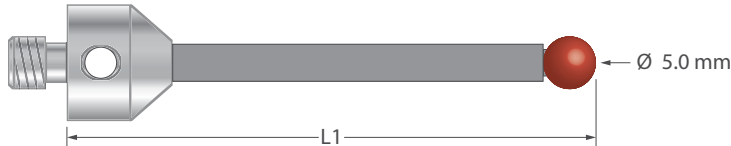

Part Number	L1	Wt	Ruby	Silicon Nitride*	Zirconia**
ATG-5050-TX	50.0	3.99	\$110.00	\$145.00	\$145.00
ATG-5075-TX	75.0	4.36	\$120.00	\$150.00	\$150.00
ATG-50100-TX	100.0	4.74	\$150.00	\$180.00	\$180.00

M5 stylus with 5.0 mm diameter ball, 3.5 mm diameter Therm-X carbon fiber stem, and 11.0 mm diameter x 10.0 mm long titanium base.

5.5 mm ball with 2.0 mm carbide stem

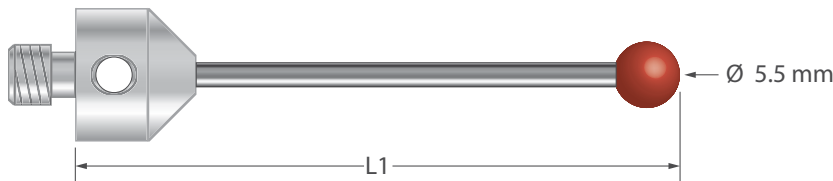

Part Number	L1	Wt	Ruby
ATG-5550-DS2	50.0	7.75	\$95.00
ATG-5575-DS2	75.0	8.86	\$105.00

M5 stylus with 5.5 mm diameter ruby ball, 2.0 mm diameter carbide stem, and 11.0 mm diameter x 10.0 mm long stainless steel base.

5.5 mm ball with 3.5 mm carbide stem

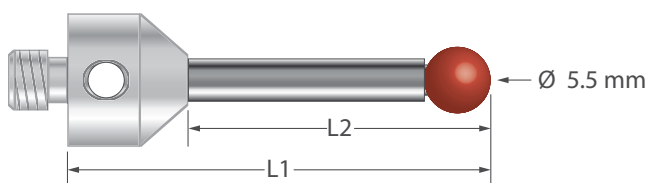

Part Number	L1	L2	Wt	Ruby
ATG-5533	33.0	23.0	8.98	\$94.00
ATG-5550	50.0	40.0	11.33	\$99.00
ATG-55100	100.0	90.0	18.25	\$117.00
ATG-55120	120.0	110.0	21.01	\$132.00
ATG-55125	125.0	110.0	23.26	\$132.00
ATG-55140	140.0	125.0	25.34	\$138.00

M5 stylus with 5.5 mm diameter ruby ball, 3.5 mm diameter carbide stem, and 11.0 mm diameter stainless steel base.

6.0 mm ball with 3.5 mm carbide stem

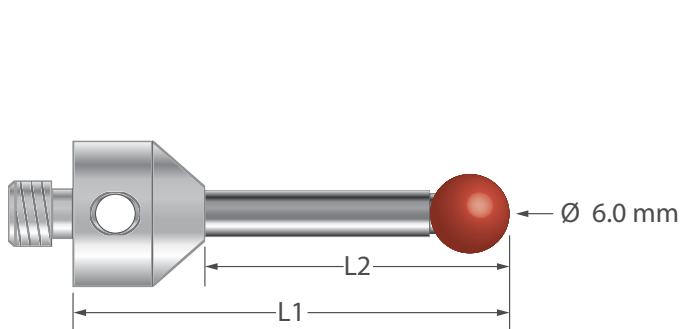

Part Number	L1	L2	Wt	Ruby	Silicon Nitride*	Zirconia**
ATG-6033	33.0	23.0	9.70	\$80.00	\$110.00	\$110.00
ATG-6040	40.0	30.0	10.67	\$80.00	\$110.00	\$110.00
ATG-6045	45.0	35.0	11.36	\$80.00	\$110.00	\$110.00
ATG-6053	53.0	43.0	12.47	\$80.00	\$110.00	\$110.00
ATG-6054	54.0	44.0	12.61	\$59.00	\$110.00	\$110.00
ATG-6055	55.0	45.0	12.75	\$85.00	\$115.00	\$115.00
ATG-6060	60.0	50.0	13.30	\$85.00	\$115.00	\$115.00
ATG-6064	64.0	54.0	13.85	\$85.00	\$115.00	\$115.00
ATG-6065	65.0	55.0	14.36	\$85.00	\$115.00	\$115.00
ATG-6070	70.0	60.0	14.54	\$95.00	\$125.00	\$125.00
ATG-6075	75.0	65.0	15.24	\$95.00	\$125.00	\$125.00
ATG-60100	100.0	90.0	18.69	\$110.00	\$140.00	\$140.00
ATG-60110	110.0	100.0	20.08	\$110.00	\$140.00	\$140.00
ATG-60125	125.0	115.0	22.15	\$120.00	\$150.00	\$150.00
ATG-60150	150.0	135.0	25.61	\$130.00	\$160.00	\$160.00

M5 stylus with 6.0 mm diameter ball, 3.5 mm diameter carbide stem, and 11.0 mm diameter stainless steel base.

*NOTE: For a **silicon nitride** ball, add **-SN** to the part number.

NOTE: For a **zirconia ball, add **-Z** to the part number.

WARNING: The products on this page can expose you to chemicals including cobalt, nickel, and phenylhydrazine, which are known to the State of California to cause cancer, and bisphenol A (BPA), which is known to the State of California to cause birth defects or other reproductive harm. For more information go to www.p65warnings.ca.gov.

M5 Threads

6.0 mm ball with 2.0 mm carbide stem

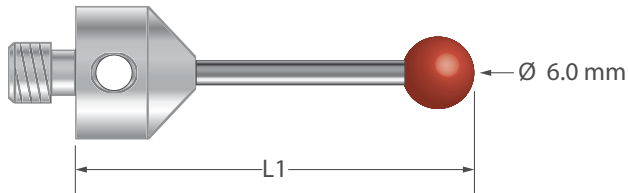

Part Number	L1	Wt	Ruby	Silicon Nitride*	Zirconia**
ATG-6025	25.0	6.96	\$75.00	\$105.00	\$105.00
ATG-6033-DS2	33.0	7.31	\$80.00	\$110.00	\$110.00

M5 stylus with 6.0 mm diameter ball, 2.0 mm diameter carbide stem, and 11.0 mm diameter x 10.0 mm long stainless steel base.

6.0 mm ball with 3.5 mm ceramic stem and aluminum base

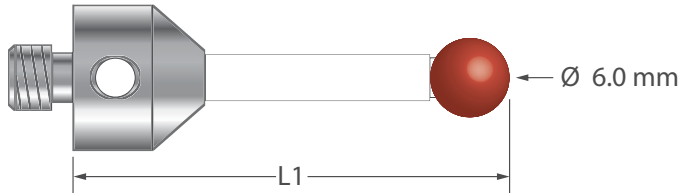

Part Number	L1	Wt	Ruby	Silicon Nitride*	Zirconia**
ATG-6050-C	50.0	3.71	\$85.00	\$115.00	\$115.00
ATG-6054-C	54.0	3.75	\$65.00	\$95.00	\$95.00
ATG-6065-C	65.0	4.27	\$90.00	\$120.00	\$120.00
ATG-6075-C	75.0	4.64	\$100.00	\$130.00	\$130.00
ATG-60100-C	100.0	5.57	\$115.00	\$145.00	\$145.00

M5 stylus with 6.0 mm diameter ball, 3.5 mm diameter ceramic stem, and 11.0 mm diameter x 10.0 mm long hard anodized aluminum base.

7.0 mm ball with 3.5 mm carbide stem

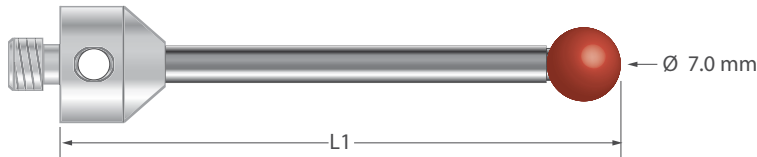

Part Number	L1	Wt	Ruby	Silicon Nitride*	Zirconia**
ATG-7053	53.0	11.69	\$95.00	\$125.00	\$125.00
ATG-7055	55.0	11.97	\$60.00	\$90.00	\$90.00
ATG-7075	75.0	14.73	\$100.00	\$130.00	\$130.00
ATG-70125	125.0	21.65	\$125.00	\$155.00	\$155.00
ATG-70130	130.0	22.34	\$125.00	\$155.00	\$155.00

M5 stylus with 7.0 mm diameter ball, 3.5 mm diameter carbide stem, and 11.0 mm diameter x 10.0 mm long stainless steel base.

7.0 mm ball with 3.5 mm ceramic stem

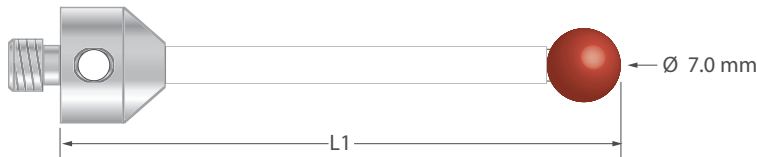

Part Number	L1	Wt	Ruby	Silicon Nitride*	Zirconia**
ATG-7055-C	55.0	4.09	\$85.00	\$115.00	\$115.00
ATG-7075-C	75.0	4.83	\$135.00	\$165.00	\$165.00

M5 stylus with 7.0 mm diameter ball, 3.5 mm diameter ceramic stem, and 11.0 mm diameter x 10.0 mm long hard anodized aluminum base.

7.0 mm ball with 3.5 mm carbon fiber stem and titanium base, Therm-X design

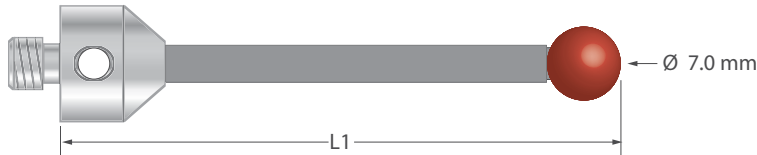

Part Number	L1	Wt	Ruby	Silicon Nitride*	Zirconia**
ATG-7055-TX	55.0	4.41	\$150.00	\$180.00	\$180.00

M5 stylus with 7.0 mm diameter ball, 3.5 mm diameter Therm-X carbon fiber stem, and 11.0 mm diameter x 10.0 mm long titanium base.

8.0 mm ball with 5.0 mm carbide stem and 13.0 mm long base

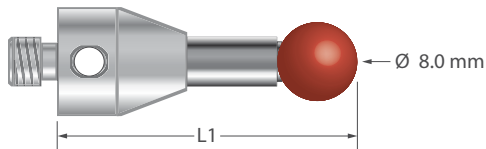

Part Number	L1	Wt	Ruby	Silicon Nitride*	Zirconia**
ATG-8025	25.0	9.59	\$110.00	\$140.00	\$140.00
ATG-8030	30.0	11.01	\$110.00	\$140.00	\$140.00

M5 stylus with 8.0 mm diameter ball, 5.0 mm diameter carbide stem, and 11.0 mm diameter x 13.0 mm long stainless steel base.

*NOTE: For a **silicon nitride** ball, add **-SN** to the part number.

NOTE: For a **zirconia ball, add **-Z** to the part number.

WARNING: The products on this page can expose you to chemicals including cobalt, nickel, and phenylhydrazine, which are known to the State of California to cause cancer, and bisphenol A (BPA), which is known to the State of California to cause birth defects or other reproductive harm. For more information go to www.p65warnings.ca.gov.

M5 Threads

8.0 mm ball with 5.0 mm carbide stem and 12.0 mm long base

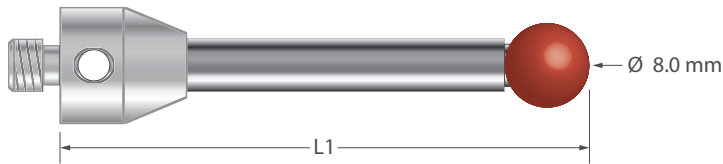

Part Number	L1	Wt	Ruby	Silicon Nitride*	Zirconia**
ATG-8064	64.0	19.79	\$89.00	\$119.00	\$119.00
ATG-8075	75.0	22.90	\$95.00	\$125.00	\$125.00
ATG-8080	80.0	24.32	\$100.00	\$130.00	\$130.00
ATG-8090	90.0	27.15	\$100.00	\$130.00	\$130.00
ATG-80100	100.0	30.35	\$110.00	\$140.00	\$140.00
ATG-80120	120.0	36.01	\$120.00	\$150.00	\$150.00
ATG-80125	125.0	37.43	\$120.00	\$150.00	\$150.00
ATG-80130	130.0	38.85	\$125.00	\$155.00	\$155.00
ATG-80135	135.0	40.26	\$125.00	\$155.00	\$155.00
ATG-80140	140.0	41.68	\$130.00	\$160.00	\$160.00
ATG-80145	145.0	43.09	\$130.00	\$160.00	\$160.00

M5 stylus with 8.0 mm diameter ball, 5.0 mm diameter carbide stem, and 11.0 mm diameter x 12.0 mm long stainless steel base.

8.0 mm ball with 6.0 mm carbide stem

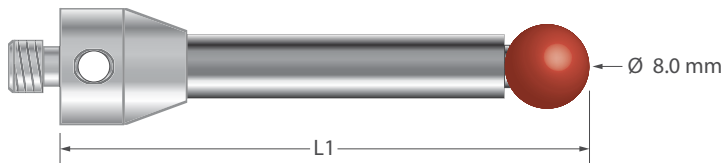

Part Number	L1	Wt	Ruby	Silicon Nitride*	Zirconia**
ATG-8040	40.0	18.84	\$110.00	\$140.00	\$140.00
ATG-8050	50.0	21.67	\$110.00	\$140.00	\$140.00
ATG-8060	60.0	24.50	\$115.00	\$145.00	\$145.00
ATG-8063.5	63.5	26.29	\$110.00	\$140.00	\$140.00
ATG-80114.5	114.5	47.07	\$70.00	\$150.00	\$150.00
ATG-80150	150.0	61.53	\$160.00	\$190.00	\$190.00
ATG-80155	155.0	63.56	\$160.00	\$190.00	\$190.00
ATG-80160	160.0	65.60	\$160.00	\$190.00	\$190.00
ATG-80175	175.0	71.72	\$165.00	\$195.00	\$195.00
ATG-80180	180.0	73.74	\$170.00	\$200.00	\$200.00
ATG-80200	200.0	81.89	\$170.00	\$200.00	\$200.00

M5 stylus with 8.0 mm diameter ball, 6.0 mm diameter carbide stem, and 11.0 mm diameter stainless steel base.

8.0 mm ball with 5.0 mm ceramic stem and aluminum base

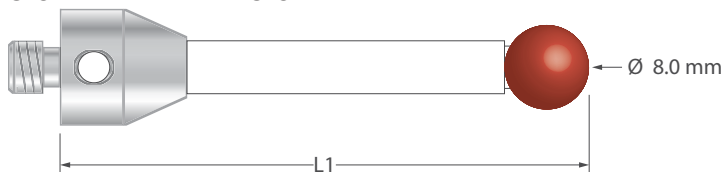

Part Number	L1	Wt	Ruby	Silicon Nitride*	Zirconia**
ATG-8053-C	53.0	5.77	\$115.00	\$145.00	\$145.00
ATG-8063-C	63.0	6.54	\$115.00	\$145.00	\$145.00
ATG-80100-C	100.0	9.37	\$120.00	\$150.00	\$150.00
ATG-80114-C	114.0	10.45	\$125.00	\$155.00	\$155.00
ATG-80135-C	135.0	12.06	\$145.00	\$175.00	\$175.00

M5 stylus with 8.0 mm diameter ball, 5.0 mm diameter ceramic stem, and 11.0 mm diameter hard anodized aluminum base.

8.0 mm ball with 6.0 mm ceramic stem and aluminum base

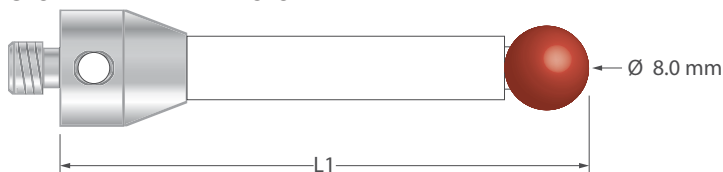

Part Number	L1	Wt	Ruby	Silicon Nitride*	Zirconia**
ATG-8063.5-C	63.5	11.87	\$85.00	\$115.00	\$115.00
ATG-80114.5-C	114.5	18.27	\$90.00	\$120.00	\$120.00
ATG-80160-C	160.0	19.01	\$195.00	\$225.00	\$225.00

M5 stylus with 8.0 mm diameter ball, 6.0 mm diameter ceramic stem, and 11.0 mm diameter x 13.0 mm long hard anodized aluminum base.

*NOTE: For a **silicon nitride** ball, add **-SN** to the part number.

NOTE: For a **zirconia ball, add **-Z** to the part number.

WARNING: The products on this page can expose you to chemicals including cobalt, nickel, and phenylhydrazine, which are known to the State of California to cause cancer, and bisphenol A (BPA), which is known to the State of California to cause birth defects or other reproductive harm. For more information go to www.p65warnings.ca.gov.

M5 Threads

8.0 mm ball with 6.0 mm ceramic stem and stainless steel base

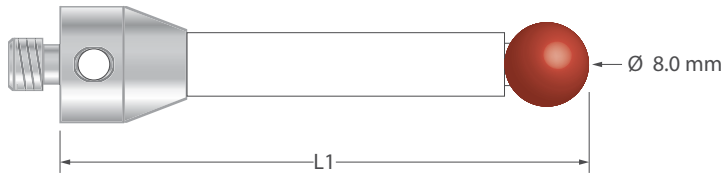

Part Number	L1	Wt	Ruby	Silicon Nitride*	Zirconia**
ATG-80175-C	175.0	25.68	\$195.00	\$225.00	\$225.00

M5 stylus with 8.0 mm diameter ball, 6.0 mm diameter ceramic stem, and 11.0 mm diameter x 16.0 mm long stainless steel base.

8.0 mm ball with 6.0 mm carbon fiber stem

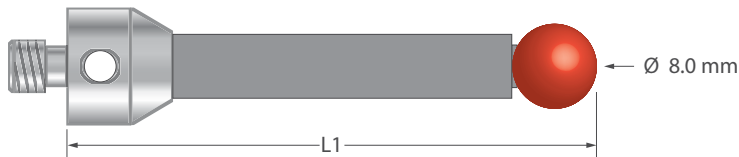

Part Number	L1	Wt	Ruby	Silicon Nitride*	Zirconia**
ATG-8054-G	54.0	7.88	\$104.00	\$134.00	\$134.00
ATG-8079-G	79.0	8.92	\$110.00	\$140.00	\$140.00

M5 stylus with 8.0 mm diameter ball, 6.0 mm diameter carbon fiber stem, and 11.0 mm diameter stainless steel base.

8.0 mm ball with 6.0 mm carbon fiber stem and titanium base, Therm-X design

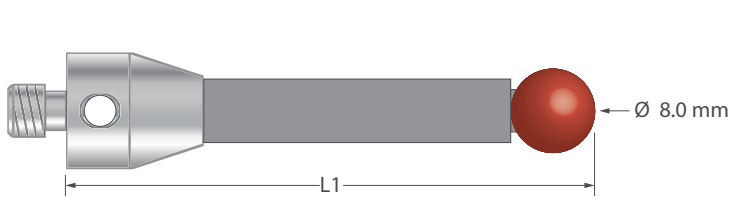

Part Number	L1	Wt	Ruby	Silicon Nitride*	Zirconia**
ATG-8063-TX	63.0	6.27	\$160.00	\$190.00	\$190.00
ATG-8075-TX	75.0	6.80	\$165.00	\$195.00	\$195.00
ATG-80100-TX	100.0	7.90	\$165.00	\$195.00	\$195.00
ATG-80114-TX	114.0	8.51	\$170.00	\$200.00	\$200.00
ATG-80150-TX	150.0	10.09	\$185.00	\$215.00	\$215.00
ATG-80200-TX	200.0	12.28	\$200.00	\$230.00	\$230.00

M5 stylus with 8.0 mm diameter ball, 6.0 mm diameter Therm-X carbon fiber stem, and 11.0 mm diameter x 13.0 mm long titanium base.

9.0 mm ball with 5.0 mm carbide stem

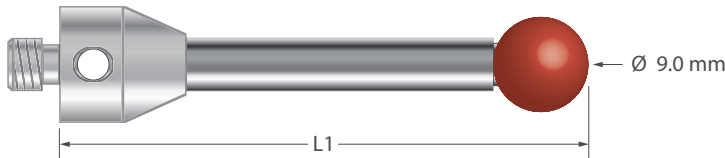

Part Number	L1	Wt	Ruby	Silicon Nitride*	Zirconia**
ATG-9075*	75.0	15.21	\$145.00	\$175.00	\$175.00
ATG-90150	150.0	45.49	\$160.00	\$190.00	\$190.00
ATG-90165	165.0	49.74	\$160.00	\$190.00	\$190.00

M5 stylus with 9.0 mm diameter ball, 5.0 mm diameter carbide stem, and 11.0 mm diameter stainless steel base. *ATG-9075 stem is 3.5 mm diameter.

9.0 mm ball with 6.0 mm carbide stem

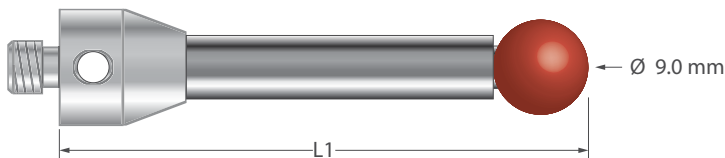

Part Number	L1	Wt	Ruby	Silicon Nitride*	Zirconia**
ATG-9064.5	64.5	22.49	\$63.00	\$93.00	\$93.00

M5 stylus with 9.0 mm diameter ball, 6.0 mm diameter carbide stem, and 11.0 mm diameter x 13.0 mm long hard anodized aluminum base.

9.0 mm ball with 6.0 mm ceramic stem

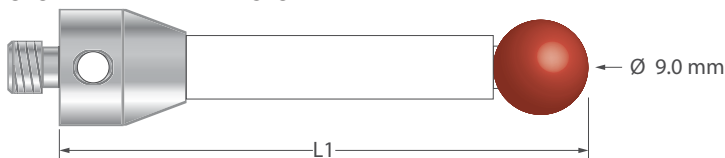

Part Number	L1	Wt	Ruby	Silicon Nitride*	Zirconia**
ATG-9064.5-C	64.5	8.89	\$120.00	\$150.00	\$150.00

M5 stylus with 9.0 mm diameter ball, 6.0 mm diameter ceramic stem, and 11.0 mm diameter x 13.0 mm long hard anodized aluminum base.

*NOTE: For a **silicon nitride** ball, add **-SN** to the part number.

NOTE: For a **zirconia ball, add **-Z** to the part number.



WARNING: The products on this page can expose you to chemicals including cobalt, nickel, and phenylhydrazine, which are known to the State of California to cause cancer, and bisphenol A (BPA), which is known to the State of California to cause birth defects or other reproductive harm. For more information go to www.p65warnings.ca.gov.

M5 Threads

10.0 mm ball with 6.0 mm carbide stem

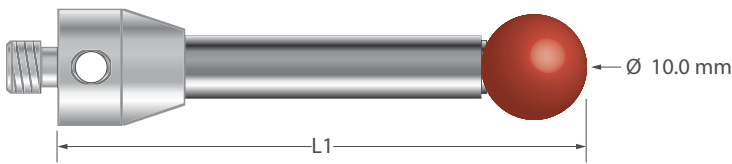

Part Number	L1	Wt	Ruby	Silicon Nitride*
ATG-10060	60.0	25.32	\$170.00	\$200.00
ATG-10065.5	65.5	32.46	\$75.00	\$200.00
ATG-100118	118.0	48.94	\$85.00	\$205.00
ATG-100135	135.0	55.87	\$210.00	\$240.00
ATG-100150	150.0	61.98	\$220.00	\$250.00
ATG-100200	200.0	83.23	\$235.00	\$265.00

M5 stylus with 10.0 mm diameter ball, 6.0 mm diameter carbide stem, and 11.0 mm diameter stainless steel base.

10.0 mm ball with 6.0 mm carbon fiber stem



Part Number	L1	Wt	Ruby	Silicon Nitride*
ATG-10055-G	55.0	8.77	\$112.00	\$142.00
ATG-10080-G	80.0	9.87	\$122.00	\$152.00

M5 stylus with 10.0 mm diameter ball, 6.0 mm diameter carbon fiber stem, and 11.0 mm diameter base.

10.0 mm ball with 6.0 mm carbon fiber stem and titanium base, Therm-X design



Part Number	L1	Wt	Ruby	Silicon Nitride*
ATG-10030-TX	30.0	5.21	\$200.00	\$230.00
ATG-10065-TX	65.0	7.08	\$200.00	\$230.00
ATG-100118-TX	118.0	9.46	\$210.00	\$240.00
ATG-100150-TX	150.0	10.86	\$240.00	\$270.00
ATG-100200-TX	200.0	13.06	\$260.00	\$290.00

M5 stylus with 10.0 mm diameter ball, 6.0 mm diameter Therm-X carbon fiber stem, and 11.0 mm diameter x 13.0 mm long titanium base.

12.0 mm ball with 5.0 mm carbide stem

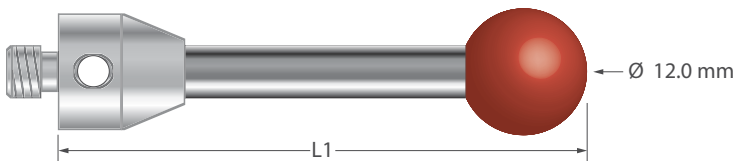

Part Number	L1	Wt	Ruby	Silicon Nitride*
ATG-12050	50.0	18.15	\$260.00	\$290.00
ATG-12075	75.0	25.23	\$260.00	\$290.00

M5 stylus with 12.0 mm diameter ball, 5.0 mm diameter carbide stem, and 11.0 mm diameter stainless steel base.

12.0 mm ball with 6.0 mm carbide stem

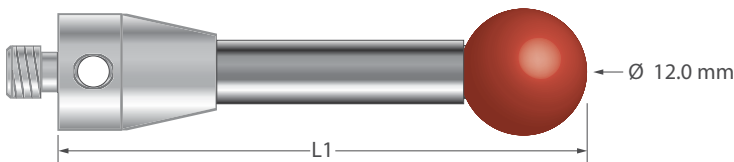

Part Number	L1	Wt	Ruby	Silicon Nitride*
ATG-120118	118.0	49.51	\$330.00	\$360.00
ATG-120160	160.0	67.24	\$345.00	\$370.00
ATG-120200	200.0	83.53	\$375.00	\$400.00

M5 stylus with 10.0 mm diameter ball, 6.0 mm diameter carbide stem, and 11.0 mm diameter stainless steel base.

12.7 mm ball with 5.0 mm carbide stem

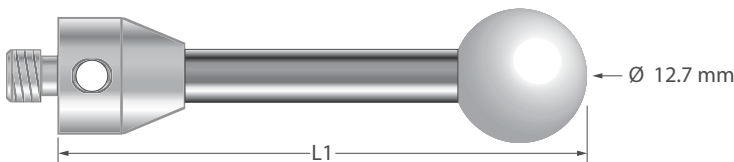

Part Number	L1	Wt	Ceramic	Silicon Nitride*
ATG-12750	50.0	18.50	\$185.00	\$340.00
ATG-12775	75.0	25.61	\$195.00	\$350.00
ATG-127100	100.0	32.69	\$210.00	\$365.00

M5 stylus with 12.7 mm diameter ball, 5.0 mm diameter carbide stem, and 11.0 mm diameter stainless steel base. All balls are Grade 25.

*NOTE: For a **silicon nitride** ball, add **-SN** to the part number.

NOTE: For a **zirconia ball, add **-Z** to the part number.



WARNING: The products on this page can expose you to chemicals including cobalt, nickel, and phenylhydrazine, which are known to the State of California to cause cancer, and bisphenol A (BPA), which is known to the State of California to cause birth defects or other reproductive harm. For more information go to www.p65warnings.ca.gov.

M5 Threads

12.7 mm ball with 6.0 mm carbide stem

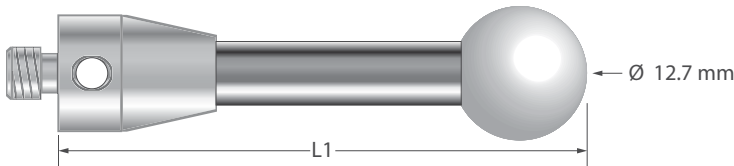

Part Number	L1	Wt	Ceramic	Silicon Nitride*
ATG-127190	190.0	79.13	\$250.00	\$405.00

M5 stylus with 12.7 mm diameter ball, 6.0 mm diameter carbide stem, and 11.0 mm diameter stainless steel base. All balls are Grade 25.

15.0 mm ceramic ball with 5.0 mm carbide stem

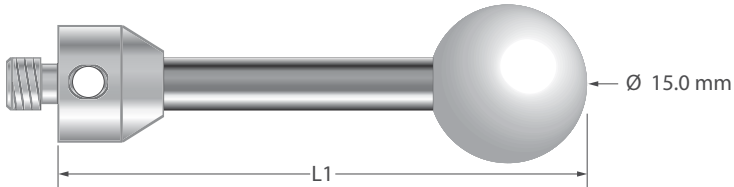

Part Number	L1	Wt	Ceramic	Silicon Nitride*
ATG-15030	30.0	14.56	\$175.00	\$310.00
ATG-15050	50.0	20.59	\$185.00	\$320.00
ATG-15075	75.0	27.67	\$195.00	\$330.00
ATG-150100	100.0	34.74	\$210.00	\$345.00
ATG-150114	114.0	38.71	\$215.00	\$350.00

M5 stylus with 15.0 mm diameter ball, 5.0 mm diameter carbide stem, and 11.0 mm diameter stainless steel base. All balls are Grade 25.

15.0 mm ball with 6.0 mm carbide stem

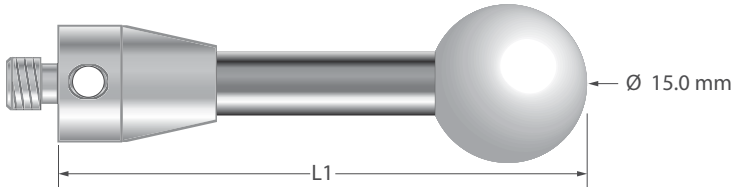

Part Number	L1	Wt	Ceramic	Silicon Nitride*
ATG-150155	155.0	67.54	\$235.00	\$370.00
ATG-150190	190.0	81.79	\$240.00	\$375.00
ATG-150250	250.0	108.27	\$295.00	\$430.00

M5 stylus with 15.0 mm diameter ball, 6.0 mm diameter carbide stem, and 11.0 mm diameter stainless steel base. All balls are Grade 25.

19.05 mm ball with 5.0 mm carbide stem

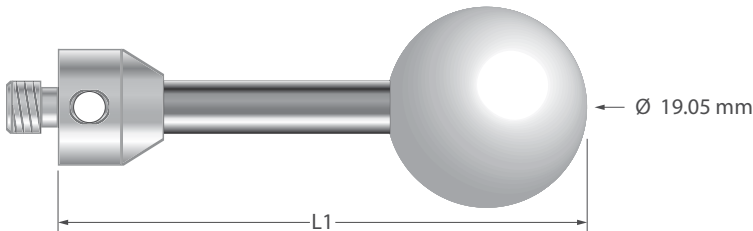

Part Number	L1	Wt	Ceramic	Silicon Nitride*
ATG-19040	40.0	25.56	\$245.00	\$395.00
ATG-19050	50.0	28.39	\$245.00	\$395.00
ATG-19080	80.0	36.88	\$260.00	\$410.00

M5 stylus with 19.05 mm (3/4") diameter ball, 5.0 mm diameter carbide stem, and 11.0 mm diameter stainless steel base. All balls Grade 25.

25.0 mm ball with 6.0 mm carbide stem

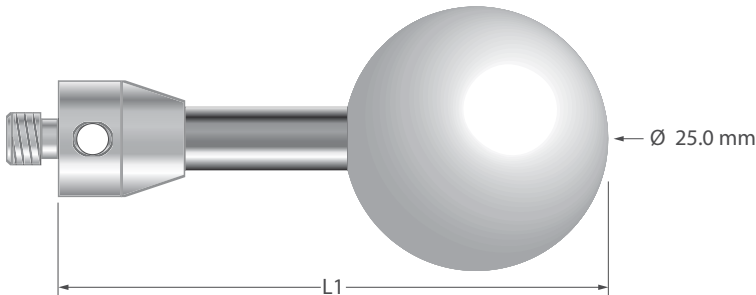

Part Number	L1	Wt	Ceramic	Silicon Nitride*
ATG-25052	52.0	38.72	\$298.00	\$598.00
ATG-250100	100.0	44.72	\$350.00	\$650.00

M5 stylus with 25.0 mm diameter ball, 6.0 mm diameter carbide stem, and 11.0 mm diameter stainless steel base. All balls are Grade 25.

*NOTE: For a **silicon nitride** ball, add **-SN** to the part number.



WARNING: The products on this page can expose you to chemicals including cobalt, nickel, and phenylhydrazine, which are known to the State of California to cause cancer, and bisphenol A (BPA), which is known to the State of California to cause birth defects or other reproductive harm. For more information go to www.p65warnings.ca.gov.

M5 Threads

Extra long styli

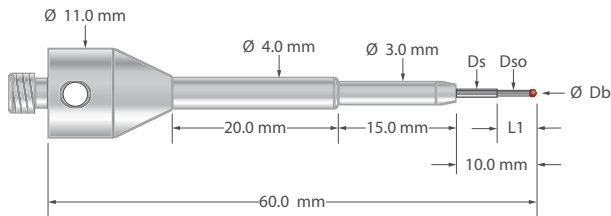

Part Number	Db	Ds	Dso	L1	Wt	Ruby	Carbide	Silicon Nitride*	Zirconia**
ASG-0360-C	0.3	1.0	0.2	2.3	11.15	-	\$148.00	-	-
ASG-0360-R	0.3	1.0	0.2	2.3	11.13	\$138.00	-	-	-
ASG-0560-C	0.5	1.0	0.3	2.5	11.11	-	\$128.00	-	-
ASG-0560-R	0.5	1.0	0.3	2.5	11.16	\$118.00	-	-	-
ASG-0660-C	0.6	1.0	0.4	4.0	11.13	-	\$138.00	-	-
ASG-0860	0.8	1.0	0.6	4.0	11.15	\$90.00	-	\$120.00	\$120.00
ASG-1060	1.0	1.0	0.7	5.0	11.21	\$80.00	-	\$110.00	\$110.00
ASG-1360	1.35	1.0	-	10.0	11.20	\$80.00	-	\$110.00	\$110.00
ASG-1560	1.5	1.0	-	10.0	11.21	\$80.00	-	\$110.00	\$110.00
ASG-2060	2.0	1.0	-	10.0	11.21	\$75.00	-	\$105.00	\$105.00
ASG-2560	2.5	1.5	-	10.0	11.22	\$75.00	-	\$105.00	\$105.00
ASG-3060	3.0	1.5	-	10.0	11.36	\$88.00	-	\$118.00	\$118.00

M5 stylus with ball, carbide stem, and 11.0 mm diameter x 50.0 mm long stainless steel base.

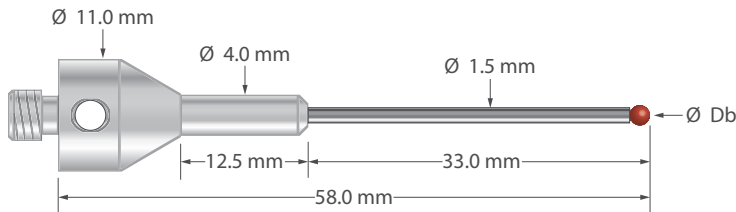

Part Number	Db	Wt	Ruby	Silicon Nitride*	Zirconia**
ARG-2058	2.0	8.22	\$80.00	\$105.00	\$105.00
ARG-2558	2.5	8.28	\$53.00	\$83.00	\$83.00

M5 stylus with ball, carbide stem, and 11.0 mm diameter x 25.0 mm long stainless steel base.

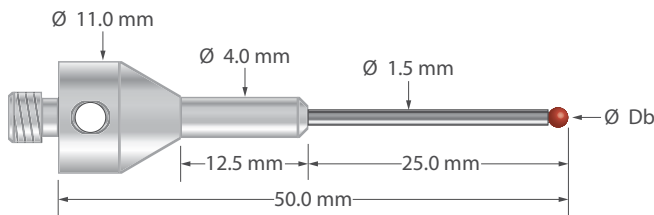

Part Number	Db	Wt	Ruby	Silicon Nitride*	Zirconia**
ARG-2050	2.0	7.64	\$53.00	\$83.00	\$83.00

M5 stylus with ball, carbide stem, and 11.0 mm diameter x 25.0 mm long stainless steel base.

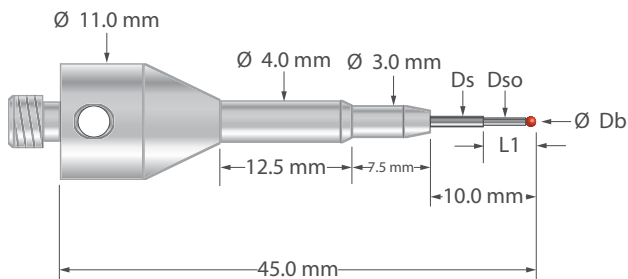

Part Number	Db	Ds	Dso	L1	Wt	Ruby	Silicon Nitride*	Zirconia**
ASG-1045	1.0	1.0	0.7	5.0	10.23	\$75.00	\$105.00	\$105.00
ASG-1545	1.5	1.0	-	10.0	10.25	\$65.00	\$95.00	\$95.00

M5 stylus with ball, carbide stem, and 11.0 mm diameter x 25.0 mm long stainless steel base.

*NOTE: For a **silicon nitride** ball, add **-SN** to the part number.

NOTE: For a **zirconia ball, add **-Z** to the part number.

WARNING: The products on this page can expose you to chemicals including cobalt, nickel, and phenylhydrazine, which are known to the State of California to cause cancer, and bisphenol A (BPA), which is known to the State of California to cause birth defects or other reproductive harm. For more information go to www.p65warnings.ca.gov.

M5 Threads

Extra long styli

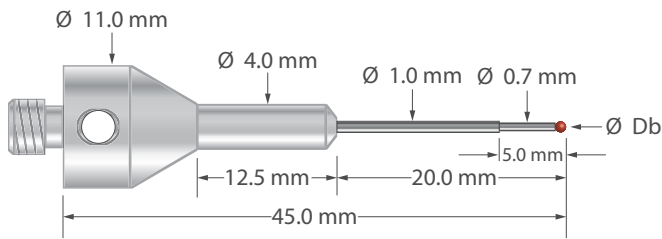

Part Number	Db	Wt	Ruby	Silicon Nitride*	Zirconia**
ARG-1045	1.0	7.70	\$75.00	\$105.00	\$105.00

M5 stylus with ball, carbide stem, and 11.0 mm diameter x 25.0 mm long stainless steel base.

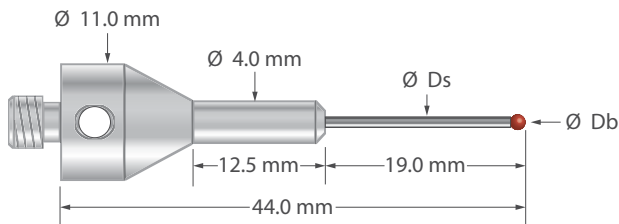

Part Number	Db	Ds	Wt	Ruby	Silicon Nitride*	Zirconia**
ARG-1444	1.35	1.0	7.66	\$75.00	\$105.00	\$105.00
ARG-1544	1.5	1.0	7.66	\$65.00	\$95.00	\$95.00
ARG-2044	2.0	1.5	7.68	\$53.00	\$83.00	\$83.00
ARG-2544	2.5	1.5	7.69	\$62.00	\$92.00	\$92.00

M5 stylus with ball, carbide stem and 11.0 mm diameter x 25.0 mm long stainless steel base.

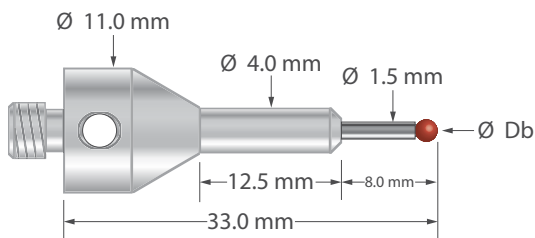

Part Number	Db	Wt	Ruby	Silicon Nitride*	Zirconia**
ARG-2033	2.0	7.60	\$53.00	\$83.00	\$83.00

M5 stylus with ball, carbide stem and 11.0 mm diameter x 25.0 mm long stainless steel base.

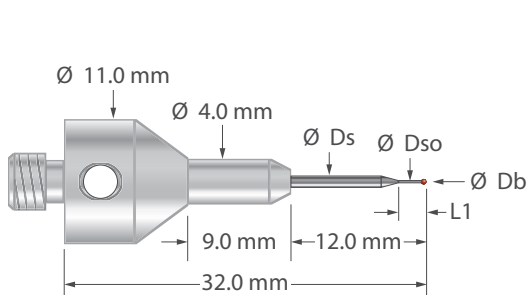

Part Number	Db	L1	Ds	Dso	Wt	Ruby	Silicon Nitride*	Zirconia**
AQG-0332	0.3	2.3	1.0	0.2	7.08	\$138.00	-	-
AQG-0532	0.5	2.5	1.0	0.3	7.09	\$115.00	-	\$145.00
AQG-0632	0.6	3.5	1.0	0.4	7.10	\$85.00	-	\$115.00
AQG-0832	0.8	4.0	1.0	0.6	7.12	\$65.00	-	\$95.00
AQG-1032	1.0	5.0	1.0	0.7	7.13	\$75.00	\$105.00	\$105.00
AQG-1432	1.35	12.0	1.0	-	7.12	\$55.00	\$85.00	\$85.00
AQG-1532	1.5	12.0	1.0	-	7.13	\$53.00	\$83.00	\$83.00
AQG-2032	2.0	12.0	1.5	-	7.15	\$53.00	\$83.00	\$83.00
ASG-2532	2.5	12.0	1.5	-	7.18	\$53.00	\$83.00	\$83.00

M5 stylus with ball, carbide stem and 11.0 mm diameter x 20.0 mm long stainless steel base.

*NOTE: For a **silicon nitride** ball, add **-SN** to the part number.

NOTE: For a **zirconia ball, add **-Z** to the part number.

WARNING: The products on this page can expose you to chemicals including cobalt, nickel, and phenylhydrazine, which are known to the State of California to cause cancer, and bisphenol A (BPA), which is known to the State of California to cause birth defects or other reproductive harm. For more information go to www.p65warnings.ca.gov.

M5 Threads

“Red Dot” master stylus

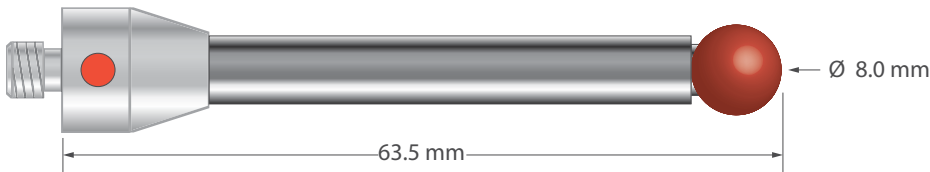

Part Number	Wt	Ruby	Silicon Nitride*
RD-MP	26.51	\$119.00	\$151.00

M5 “Red Dot” master stylus with 8.0 mm diameter ball, 6.0 mm diameter carbide stem, and 11.0 mm diameter x 13.0 mm long stainless steel base.

Important notes about cylinder styli

Cylinder styli are used for edge probing, for instance, the edges of stampings and thin sheet metal parts. Cylinder styli are not suitable for high accuracy work because the form of a cylinder is not as precise as a sphere. Please contact us with any questions about how to calibrate or use cylinder styli.

Ruby cylinder styli

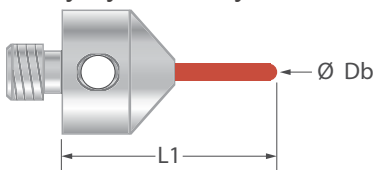

Part Number	Db	L1	Wt	Price
TM5-1019-B	1.0	19.0	5.51	\$143.00
TM5-1514-B	1.5	14.0	5.52	\$108.00
TM5-1519-B	1.5	19.0	5.53	\$108.00

M5 stylus with ruby cylinder and 11.0 mm diameter x 10.0 mm long stainless steel base.

Ruby cylinder styli with carbide stems

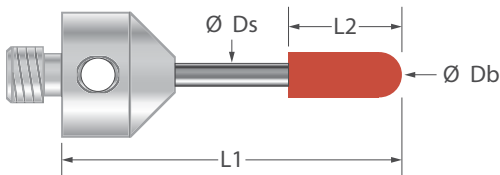

Part Number	Db	Ds	L1	L2	Wt	Price
TM5-2020-B	2.0	1.0	20.0	7.2	3.18	\$225.00
TM5-2025-B	2.0	1.0	25.0	7.2	3.23	\$225.00
TM5-2030-B	2.0	1.0	30.0	7.2	3.29	\$225.00
TM5-2035-B	2.0	1.0	35.0	7.2	3.35	\$230.00
TM5-2040-B	2.0	1.0	40.0	7.2	3.41	\$230.00
TM5-2060-B	2.0	1.0	60.0	7.2	3.53	\$425.00
TM5-4020-B	4.0	2.0	20.0	10.0	3.92	\$230.00
TM5-4025-B	4.0	2.0	25.0	10.0	4.15	\$230.00
TM5-4030-B	4.0	2.0	30.0	10.0	4.37	\$230.00
TM5-4040-B	4.0	2.0	40.0	10.0	4.82	\$235.00
TM5-4050-B	4.0	2.0	50.0	10.0	5.27	\$235.00

M5 stylus with ruby cylinder, carbide stem, and 11.0 mm diameter x 10.0 mm long titanium base.

Carbide cylinder styli

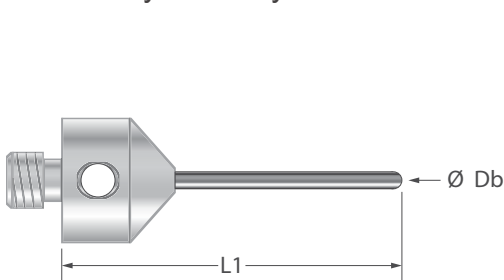

Part Number	Db	L1	Wt	Price
TM5-1040-BC	1.0	40.0	5.74	\$120.00
TM5-1520-BC	1.5	20.0	5.96	\$108.00
TM5-1530-BC	1.5	30.0	6.21	\$126.00
TM5-1540-BC	1.5	40.0	6.46	\$126.00
TM5-2020-BC	2.0	20.0	6.28	\$108.00
TM5-2030-BC	2.0	30.0	6.72	\$110.00
TM5-2040-BC	2.0	40.0	7.17	\$115.00
TM5-3025-BC	3.0	25.0	7.41	\$121.00
TM5-3050-BC	3.0	50.0	9.93	\$125.00
TM5-30100-BC	3.0	100.0	14.98	\$135.00
TM5-30130-BC	3.0	130.0	18.01	\$145.00
TM5-5050-BC	5.0	50.0	17.72	\$160.00
TM5-50100-BC	5.0	100.0	31.88	\$170.00

M5 stylus with carbide cylinder and 11.0 mm diameter x 10.0 mm long stainless steel base.



WARNING: The products on this page can expose you to chemicals including cobalt, nickel, and phenylhydrazine, which are known to the State of California to cause cancer, and bisphenol A (BPA), which is known to the State of California to cause birth defects or other reproductive harm. For more information go to www.p65warnings.ca.gov.

M5 Threads

Extensions, aluminum, 11.0 mm diameter

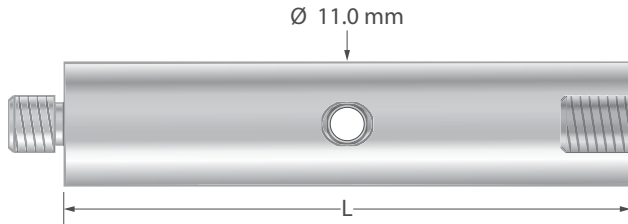

Part Number	L	Wt	Price
VM5-12.10-A	10.0	2.97	\$25.00
VM5-12.15-A	15.0	3.92	\$25.00
VM5-12.20-A	20.0	5.69	\$25.00
VM5-12.25-A	25.0	6.78	\$25.00
VM5-12.30-A	30.0	7.87	\$25.00
VM5-12.35-A	35.0	8.96	\$25.00
VM5-12.40-A	40.0	10.18	\$30.00
VM5-12.50-A	50.0	12.98	\$32.00
VM5-12.60-A	60.0	15.48	\$30.00
VM5-12.70-A	70.0	18.07	\$30.00
VM5-12.75-A	75.0	19.16	\$32.00
VM5-12.80-A	80.0	20.54	\$28.00
VM5-12.100-A	100.0	26.03	\$35.00
VM5-12.120-A	120.0	30.30	\$35.00
VM5-12.150-A	150.0	37.83	\$50.00
VM5-12.200-A	200.0	50.21	\$80.00

M5 extension, hard anodized aluminum. The wrench hole has a stainless steel liner.

Extensions, aluminum, 20.0 mm diameter

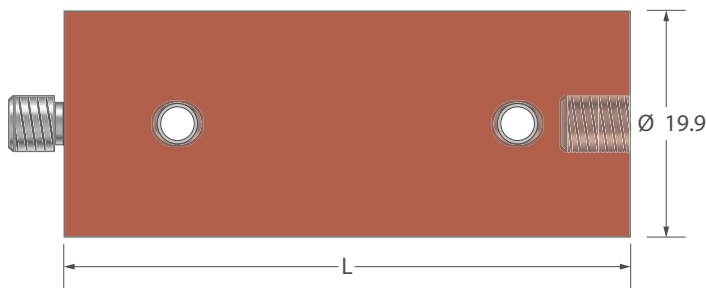

Part Number	L	Wt	Price
VM5-20.40-A	40.0	28.61	\$50.00
VM5-20.50-A	50.0	32.17	\$55.00
VM5-20.60-A	60.0	36.89	\$60.00
VM5-20.75-A	75.0	42.48	\$60.00
VM5-20.80-A	80.0	43.76	\$65.00
VM5-20.90-A	90.0	47.87	\$65.00
VM5-20.100-A	100.0	51.63	\$65.00
VM5-20.120-A	120.0	58.82	\$70.00
VM5-20.150-A	150.0	69.78	\$75.00
VM5-20.200-A	200.0	88.29	\$80.00
VM5-20.250-A	250.0	106.67	\$90.00
VM5-20.300-A	300.0	125.49	\$100.00

M5 extension, red anodized seamless aluminum tubing with stainless steel end fittings. Wrench holes have stainless steel liners.

Extensions, titanium, 11.0 mm diameter

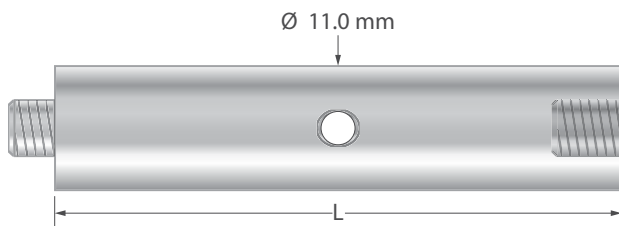

Part Number	L	Wt	Price
VM5-12.10-T	10.0	3.53	\$27.00
VM5-12.15-T	15.0	5.40	\$25.00
VM5-12.20-T	20.0	7.74	\$26.00
VM5-12.25-T	25.0	9.84	\$30.00
VM5-12.30-T	30.0	11.94	\$50.00
VM5-12.35-T	35.0	14.04	\$50.00
VM5-12.40-T	40.0	16.14	\$32.00
VM5-12.50-T	50.0	20.33	\$35.00
VM5-12.60-T	60.0	24.53	\$40.00
VM5-12.75-T	75.0	30.83	\$45.00
VM5-12.80-T	80.0	32.93	\$39.00
VM5-12.100-T	100.0	41.33	\$45.00
VM5-12.120-T	120.0	49.72	\$45.00
VM5-12.150-T	150.0	62.50	\$49.00
VM5-12.200-T	200.0	83.80	\$80.00

M5 extension, solid titanium.

WARNING: The products on this page can expose you to chemicals including cobalt, nickel, and phenylhydrazine, which are known to the State of California to cause cancer, and bisphenol A (BPA), which is known to the State of California to cause birth defects or other reproductive harm. For more information go to www.p65warnings.ca.gov.

M5 Threads

Extensions, titanium, 19.2 mm diameter

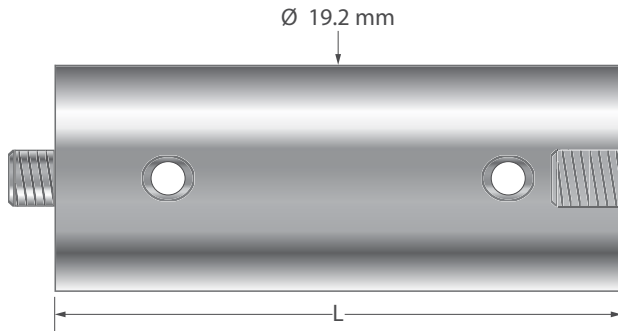

Part Number	L	Wt	Price
VM5-18.40-TT	40.0	30.18	\$80.00
VM5-18.50-TT	50.0	31.00	\$80.00
VM5-18.55-TT	55.0	34.05	\$85.00
VM5-18.60-TT	60.0	36.69	\$90.00
VM5-18.75-TT	75.0	38.38	\$90.00
VM5-18.80-TT	80.0	39.74	\$90.00
VM5-18.90-TT	90.0	41.88	\$95.00
VM5-18.100-TT	100.0	43.46	\$100.00
VM5-18.120-TT	110.0	51.95	\$105.00
VM5-18.150-TT	150.0	60.87	\$120.00
VM5-18.170-TT	170.0	73.69	\$130.00
VM5-18.180-TT	180.0	76.41	\$130.00
VM5-18.200-TT	200.0	84.47	\$135.00
VM5-18.250-TT	250.0	102.34	\$150.00
VM5-18.300-TT	300.0	120.48	\$160.00

M5 extensions, seamless titanium tubing with welded titanium end caps and stainless steel end fittings.

Extensions, Therm-X carbon fiber body with titanium end fittings, 11.2 mm diameter

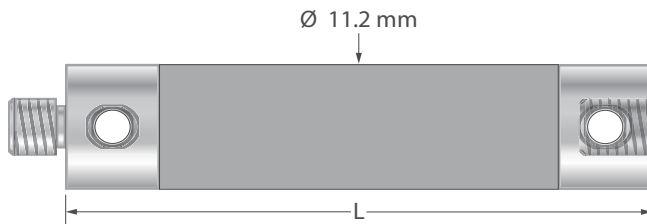

Part Number	L	Wt	Price
VM5-12.35-TX	35.0	9.39	\$155.00
VM5-12.40-TX	40.0	9.75	\$155.00
VM5-12.50-TX	50.0	10.48	\$160.00
VM5-12.55-TX	55.0	10.84	\$160.00
VM5-12.60-TX	60.0	11.20	\$165.00
VM5-12.70-TX	70.0	11.93	\$170.00
VM5-12.75-TX	75.0	12.29	\$175.00
VM5-12.80-TX	80.0	12.65	\$175.00
VM5-12.100-TX	100.0	14.10	\$180.00
VM5-12.110-TX	110.0	14.83	\$190.00
VM5-12.120-TX	120.0	15.55	\$190.00
VM5-12.125-TX	125.0	15.92	\$195.00
VM5-12.130-TX	130.0	16.28	\$195.00
VM5-12.140-TX	140.0	17.00	\$200.00
VM5-12.150-TX	150.0	17.73	\$205.00
VM5-12.155-TX	155.0	18.09	\$205.00
VM5-12.160-TX	160.0	18.45	\$210.00
VM5-12.170-TX	170.0	19.18	\$220.00
VM5-12.175-TX	175.0	19.54	\$220.00
VM5-12.180-TX	180.0	19.90	\$225.00
VM5-12.200-TX	200.0	21.35	\$240.00
VM5-12.225-TX	225.0	23.17	\$250.00
VM5-12.250-TX	250.0	24.98	\$265.00
VM5-12.300-TX	300.0	28.60	\$275.00
VM5-12.350-TX	350.0	32.23	\$295.00
VM5-12.400-TX	400.0	35.85	\$325.00
VM5-12.450-TX	450.0	39.84	\$350.00
VM5-12.500-TX	500.0	43.10	\$375.00

M5 extensions, Therm-X low expansion 11.2 mm diameter silver woven carbon fiber tubing with 11.13 mm diameter titanium end fittings.



WARNING: The products on this page can expose you to chemicals including cobalt, nickel, and phenylhydrazine, which are known to the State of California to cause cancer, and bisphenol A (BPA), which is known to the State of California to cause birth defects or other reproductive harm. For more information go to www.p65warnings.ca.gov.

M5 Threads

Extensions, Therm-X carbon fiber tubing body with titanium end fittings, 20.0 mm diameter

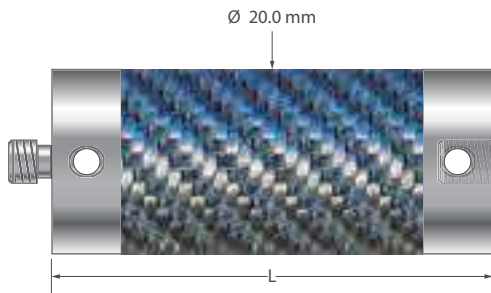

Part Number	L	Wt	Price
VM5-20.40-TX	40.0	27.77	\$170.00
VM5-20.50-TX	50.0	29.23	\$175.00
VM5-20.60-TX	60.0	31.12	\$180.00
VM5-20.80-TX	80.0	32.39	\$190.00
VM5-20.100-TX	100.0	34.60	\$200.00
VM5-20.120-TX	120.0	36.86	\$210.00
VM5-20.150-TX	150.0	39.96	\$225.00
VM5-20.200-TX	200.0	46.78	\$250.00
VM5-20.250-TX	250.0	52.38	\$275.00
VM5-20.300-TX	300.0	56.77	\$300.00

M5 extensions with Therm-X low expansion carbon fiber tubing and titanium end fittings.

M5 thread adapters

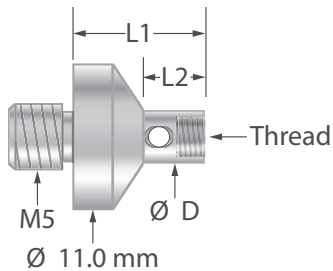

Part Number	Thread	L1	L2	D	Wt	Price
RM5-M2	M2 x 0.4	10.0	4.3	4.0	3.88	\$15.00
RM5-M3	M3 x 0.5	10.0	4.6	4.0	3.64	\$15.00
RM5-M4	M4 x 0.7	10.0	3.6	7.0	5.79	\$15.00
RM5-M4-DEA	M4 x 0.5	14.0	8.6	5.0	3.79	\$15.00
RM5-4-48	4-48 UNF	10.0	4.3	4.0	3.62	\$15.00

M5 thread adapters. Stainless steel.

M5 cubes, five sided, titanium or aluminum



Part Number	Material	Wt	Price
WM5-15-3	Aluminum	8.08	\$55.00
WM5-15-3-T	Titanium	12.46	\$65.00

M5 cubes, five sided. Titanium or hard anodized aluminum with stainless steel M5 screw.

WARNING: The products on this page can expose you to chemicals including cobalt, nickel, and phenylhydrazine, which are known to the State of California to cause cancer, and bisphenol A (BPA), which is known to the State of California to cause birth defects or other reproductive harm. For more information go to www.p65warnings.ca.gov.

M5 Threads

M5 cubes, six sided, 14.3 mm, titanium or aluminum



Part Number	Material	Wt	Price
WM5-15	Aluminum	6.89	\$60.00
WM5-15-T	Titanium	10.77	\$65.00

M5 cubes, six sided, 14.3 mm thick between sides. Hard anodized aluminum or titanium with stainless steel M5 screw.

M5 cube, six sided, 14.3 mm, titanium, with hex screw



Part Number	Material	Wt	Price
WM5-15-T-C	Titanium	12.16	\$135.00

M5 cube, six sided, titanium, 14.3 mm thick between sides. Includes a countersunk stainless steel flat head hex screw, so the cube can be positioned at any radial angle. Combined weight is 12.16 grams..

M5 cubes, six sided, 21.0 mm, titanium or aluminum



Part Number	Material	Wt	Price
WM5-20	Aluminum	22.41	\$49.00
WM5-20-T	Titanium	35.63	\$55.00

M5 cubes, six sided, 21.0 mm thick between sides. Hard anodized aluminum or titanium with stainless steel M5 screw.

M5 cube, six sided, 21.0 mm x 42.0 mm, aluminum



Part Number	Material	Wt	Price
WM5-40	Aluminum	44.62	\$70.00

M5 cube, six sided, 21.0 mm thick x 42.0 mm long, with ten M5 tapped holes. Hard anodized aluminum with stainless steel M5 screw.

M5 captive screws

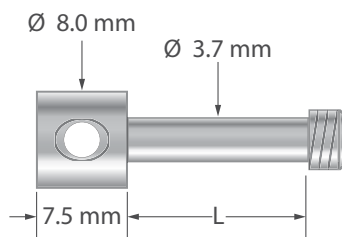

Part Number	L	Wt	Price
SM5-15	15.0	4.32	\$9.00
SM5-20	20.0	4.74	\$9.00
SM5-22	22.0	4.97	\$9.00
SM5-25	25.0	5.15	\$9.00

M5 captive screws for fastening cubes. Stainless steel.

WARNING: The products on this page can expose you to chemicals including cobalt, nickel, and phenylhydrazine, which are known to the State of California to cause cancer, and bisphenol A (BPA), which is known to the State of California to cause birth defects or other reproductive harm. For more information go to www.p65warnings.ca.gov.

M5 Threads

M5 knuckle, 11.0 mm diameter, titanium



Part Number	Material	Wt	Price
JM5-15-T	Titanium	12.20	\$76.00

M5 knuckle, titanium, 11.0 mm diameter x 35.0 mm long. With stainless steel M5 thread and socket head cap screw for tightening. 190 degree adjustment range. Includes hex wrench for tightening (not shown).

M5 knuckles, 18.0 mm diameter, titanium or aluminum



Part Number	Material	Wt	Price
JM5-20	Aluminum	22.74	\$76.00
JM5-20-T	Titanium	35.27	\$76.00

M5 knuckles, hard anodized aluminum or titanium, 18.0 mm diameter x 35.0 mm long. With stainless steel M5 thread and socket head cap screw for tightening. 190 degree adjustment range. Includes hex wrench for tightening (not shown).

M5 knuckle, 11.0 mm diameter, titanium, with rotary and lateral adjustment



Part Number	Wt	Price
RJM5-15	16.53	\$95.00

M5 knuckle with 190 degree lateral and 360 degree radial adjustment. 11.0 mm diameter x 43.5 mm long. Made of titanium, with steel and stainless steel screws. A miniature ball bearing provides smooth radial movement. Includes two hex wrenches for tightening (not shown).

M5 rotary adapter, titanium



Part Number	Wt	Price
RAP-1128-T	10.82	\$85.00

M5 rotary adapter, titanium, 11.0 mm diameter x 29.0 mm long, for radial adjustments. Two stainless steel set screws for tightening. A miniature ball bearing provides smooth radial movement. Includes hex wrench (shown).

M5 adapter with 90 degree M5 tapped hole, titanium



Part Number	Wt	Price
JM5-90-T	6.54	\$45.00

M5 adapter with 90 degree tapped M5 hole. 11.0 mm diameter titanium with stainless steel set screw. Overall length is 23.0 mm.



WARNING: The products on this page can expose you to chemicals including cobalt, nickel, and phenylhydrazine, which are known to the State of California to cause cancer, and bisphenol A (BPA), which is known to the State of California to cause birth defects or other reproductive harm. For more information go to www.p65warnings.ca.gov.

M5 Threads

M5 hubs



HUB-6

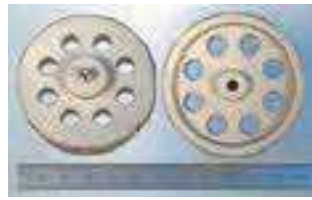

HUB-8

M5 hubs with radial tapped holes and one axial tapped hole. Hard anodized aluminum with stainless steel M5 screw.

Part Number	Diameter	Thickness	Wt	Price
HUB-6	38.0	18.0	29.24	\$225.00
HUB-8	59.0	18.0	68.33	\$245.00

Disks

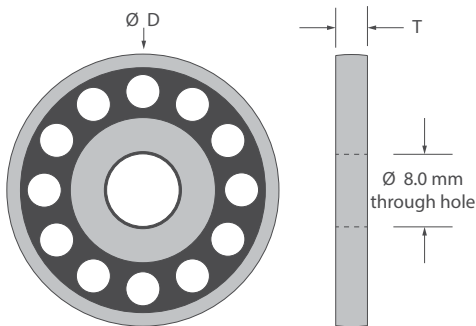

Part Number	Diameter (D)	Thickness (T)	Material	Wt	Price
DSK-300	30.0	3.5	Tool Steel	9.17	\$150.00
DSK-400	40.0	5.0	Tool Steel	19.55	\$150.00
DSK-500	50.0	7.0	Tool Steel	35.00	\$150.00
DSK-600	60.0	8.0	Tool Steel	41.44	\$150.00
DSK-800	80.0	9.0	Aluminum	44.24	\$245.00

Tool steel disks are hardened and ground. Aluminum disk is hard anodized. Use a disk screw (below) to mount to any M5 extension.

Disk screws

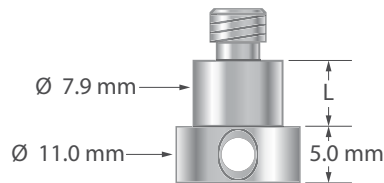

Part Number	Length (L)	Fits	Wt	Price
DS-300	2.8	DSK-300	4.30	\$10.00
DS-400	4.8	DSK-400	5.12	\$10.00
DS-500	5.8	DSK-500	5.75	\$10.00
DS-600	7.8	DSK-600	6.82	\$10.00

M5 screws for fastening disks to extensions. Stainless steel.

Multi-socket adapter styli (MSA) with stepped stems

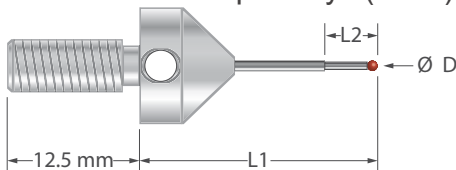

Part Number	D	L1	L2	Wt	Price
MSA-0322-R	0.3	21.8	2.5	5.65	\$51.00
MSA-0522	0.5	22.0	2.5	5.65	\$49.00
MSA-0622	0.6	22.1	4.0	5.65	\$49.00
MSA-0822	0.8	22.3	4.0	5.69	\$47.00
MSA-1023	1.0	22.5	5.0	5.74	\$46.00

M5 styli with ruby ball, stepped carbide stem, and 11.0 mm diameter x 9.0 mm long stainless steel base. Designed for use with slotted disks and clamping disks. Can be mounted directly to an M5 extension.

Multi-socket adapter styli (MSA) with straight stems

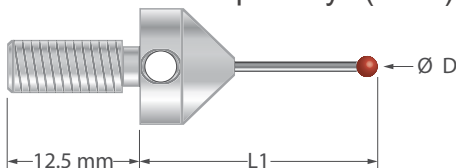

Part Number	D	L1	Wt	Price
MSA-1332	1.35	32.0	5.91	\$46.00
MSA-1533	1.5	33.0	5.83	\$44.00
MSA-2033	2.0	33.5	6.10	\$45.00
MSA-2534	2.5	34.0	6.12	\$46.00
MSA-3034.5	3.0	34.5	6.69	\$43.00

M5 styli with ruby ball, carbide stem, and 11.0 mm diameter x 9.0 mm long stainless steel base. Designed for use with slotted disks and clamping disks. Can be mounted directly to an M5 extension.



WARNING: The products on this page can expose you to chemicals including cobalt, nickel, and phenylhydrazine, which are known to the State of California to cause cancer, and bisphenol A (BPA), which is known to the State of California to cause birth defects or other reproductive harm. For more information go to www.p65warnings.ca.gov.

M5 Threads

M5 extra rigid styli with straight stem

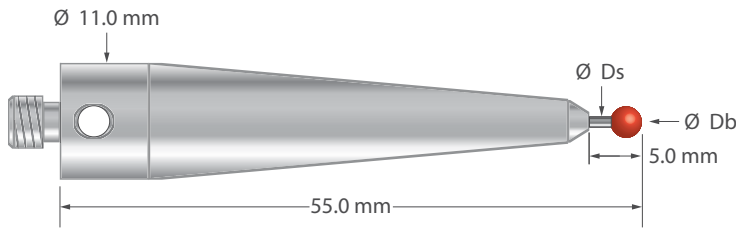

Part Number	Db	Ds	Wt	Ruby	Silicon Nitride*
ACR-1055	1.0	0.7	22.40	\$71.00	\$101.00
ACR-1555	1.5	1.0	22.41	\$95.00	\$125.00
ACR-2055	2.0	1.5	22.43	\$75.00	\$105.00
ACR-2555	2.5	1.5	22.45	\$75.00	\$105.00
ACR-3055	3.0	1.5	22.47	\$75.00	\$105.00
ACR-3555	3.5	1.5	22.55	\$75.00	\$105.00
ACR-4055	4.0	2.5	22.78	\$85.00	\$115.00

M5 stylus with ruby or silicon nitride ball, carbide stem, and 11.0 mm diameter x 50.0 mm long tapered stainless steel base.

M5 extra rigid styli with 19.0 mm diameter base

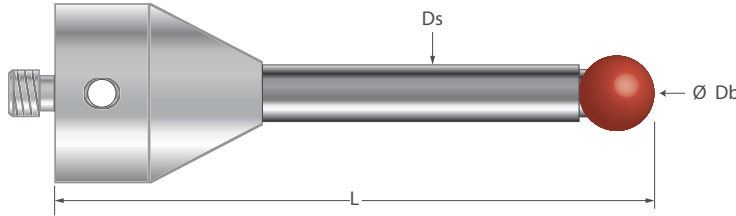

Part Number	L	Db	Ds	Wt	Ruby	Silicon Nitride*
ATG-8063.5-19	63.5	8.0	6.0	36.06	\$105.00	\$135.00
ATG-80114.5-19	114.5	8.0	6.0	57.07	\$88.00	\$118.00
ATG-9064.5-19	64.5	9.0	6.0	38.90	\$73.00	\$103.00
ATG-10065.5-19	65.5	10.0	6.0	40.06	\$175.00	\$205.00

M5 stylus with ruby or silicon nitride ball, carbide stem, and 19.0 mm diameter x 22.0 mm long stainless steel base.

M5 Pro Fit extensions with Therm-X carbon fiber body, titanium fittings, and conical receiver



Part Number	L	Wt	Price
VM5-12.50-TX-CR	50.0	11.44	\$185.00
VM5-12.60-TX-CR	60.0	12.26	\$190.00
VM5-12.70-TX-CR	70.0	13.09	\$200.00
VM5-12.80-TX-CR	80.0	13.91	\$210.00
VM5-12.90-TX-CR	90.0	14.74	\$210.00
VM5-12.100-TX-CR	100.0	15.56	\$220.00
VM5-12.110-TX-CR	110.0	16.38	\$225.00
VM5-12.130-TX-CR	130.0	18.03	\$235.00
VM5-12.160-TX-CR	160.0	20.50	\$250.00
VM5-12.190-TX-CR	190.0	22.98	\$270.00
VM5-12.200-TX-CR	200.0	23.80	\$280.00
VM5-12.210-TX-CR	210.0	24.62	\$285.00
VM5-12.240-TX-CR	240.0	27.10	\$295.00
VM5-12.260-TX-CR	260.0	28.74	\$310.00
VM5-12.310-TX-CR	310.0	32.86	\$340.00
VM5-12.410-TX-CR	410.0	41.10	\$405.00

M5 extension with 11.0 mm diameter Therm-X carbon fiber core and titanium end fittings, with a conical receiver for Pro Fit attachments.

M5 Pro Fit angle cubes

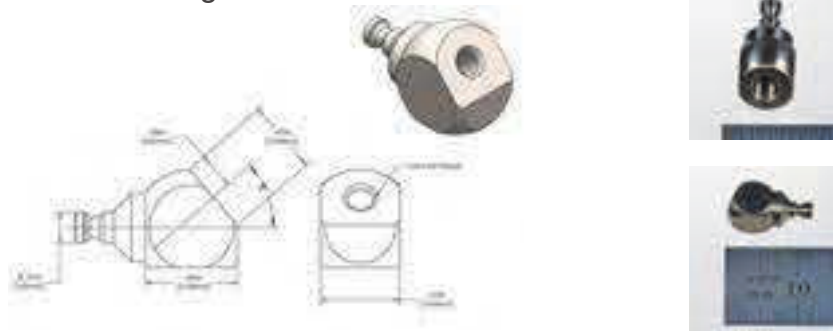

Part Number	Angle "A"	Wt	Price
WM5-15-PF-20	20.0	12.28	\$133.00
WM5-15-PF-25	25.0	12.28	\$133.00
WM5-15-PF-30	30.0	12.28	\$133.00
WM5-15-PF-35	35.0	12.28	\$133.00
WM5-15-PF-40	40.0	12.28	\$133.00
WM5-15-PF-45	45.0	12.28	\$133.00
WM5-15-PF-50	50.0	12.28	\$133.00
WM5-15-PF-60	60.0	12.28	\$133.00
WM5-15-PF-70	70.0	12.28	\$133.00
WM5-15-PF-100	100.0	12.28	\$133.00

M5 Pro Fit angle cubes with conical attachment. Titanium. Available with any angle between zero and 100 degrees. Please inquire.



WARNING: The products on this page can expose you to chemicals including cobalt, nickel, and phenylhydrazine, which are known to the State of California to cause cancer, and bisphenol A (BPA), which is known to the State of California to cause birth defects or other reproductive harm. For more information go to www.p65warnings.ca.gov.

M5 Threads

M5 Pro Fit rotary adapters

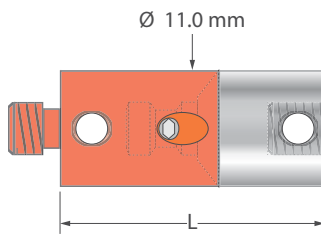

Part Number	L	Wt	Price
RAP-11PF-20	20.0	5.35	\$180.00
RAP-11PF-25	25.0	7.05	\$195.00
RAP-11PF-30	30.0	8.75	\$210.00

M5 rotary adapter, Pro Fit series. Red anodized aluminum body with titanium end fitting. Three stainless steel set screws allow unlimited axial rotation and rigid, torque-free clamping at desired position. Hex wrench included.

M5 Pro Fit rotary adapter, 90 degree

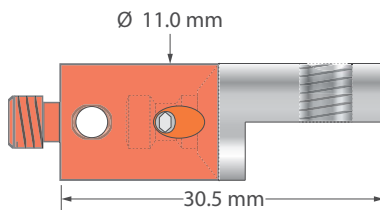

Part Number	L	Wt	Price
RAP-11PF-90A	30.5	7.42	\$170.00

M5 rotary adapter, Pro Fit series, with M5 tapped hole at 90 degrees. Red anodized aluminum body with titanium end fitting. Three stainless steel set screws allow unlimited axial rotation and rigid, torque-free clamping at desired position. Hex wrench included.

M5 Pro Fit four-way stylus holder



Part Number	Accepts Stem Diameter	Wt	Price
RAP-11PF-PH1	1.0 mm	6.83	\$260.00
RAP-11PF-PH1.5	1.5 mm	6.79	\$285.00
RAP-11PF-PH2	2.0 mm	6.70	\$285.00

M5 four-way stylus holder for unthreaded styli, Pro Fit series. Holder is 11.0 mm diameter stainless steel. Four set screws hold unthreaded styli to create a star stylus. Adjusts to any radial angle. Select 1.0, 1.5, or 2.0 mm diameter stems. Includes aluminum conical end receiver and hex wrenches.

M5 Pro Fit conical end receiver

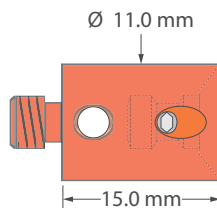

Part Number	Wt	Price
RAP-11PF-CE	2.97	\$95.00

M5 conical end receiver for Pro Fit series. 11.0 mm diameter x 15.0 mm long. Red anodized aluminum. Three stainless steel set screws allow unlimited axial rotation and rigid, torque-free clamping at desired position. Hex wrench included.



WARNING: The products on this page can expose you to chemicals including cobalt, nickel, and phenylhydrazine, which are known to the State of California to cause cancer, and bisphenol A (BPA), which is known to the State of California to cause birth defects or other reproductive harm. For more information go to www.p65warnings.ca.gov.

M5 Threads

M5 Pro Fit knuckle joint



Part Number	Wt	Price
RAP-11PF-RJM5	13.44	\$220.00

M5 knuckle joint for Pro Fit series. 11.0 mm diameter x 40.0 mm long. Titanium and aluminum. Hex wrenches included.

M5 Pro Fit cubes



RAP-11PF-WM5-15-3-T-PF

Part Number	Sides	Wt	Price
RAP-11PF-WM5-15-T-PF	5 (90 degrees)	15.38	\$245.00
RAP-11PF-WM5-15-T-3-PF	4 (120 degrees)	15.91	\$245.00

RAP-11PF-WM5-15-T-PF

M5 Pro Fit titanium cube with conical end. Includes one M5 Pro Fit conical end receiver (as shown) with hex wrench.

M5 Pro Fit 90 degree fitting



Part Number	Wt	Price
JM5-90-PF	4.45	\$85.00

ProFit rotary fitting with M5 tapped hole at 90 degrees. Titanium.



WARNING: The products on this page can expose you to chemicals including cobalt, nickel, and phenylhydrazine, which are known to the State of California to cause cancer, and bisphenol A (BPA), which is known to the State of California to cause birth defects or other reproductive harm. For more information go to www.p65warnings.ca.gov.

M5 Threads

M5 Pro Fit adapter plates



VAS-1054-PF



VAS-1054-PF-40

Adapter plates with ID chip and titanium Pro Fit cubes for VAST probe heads.

Part Number	Wt	Price
VAS-1054-PF	154.13	\$695.00
VAS-1054-PF-40	186.71	\$795.00

M5 Pro Fit extensions

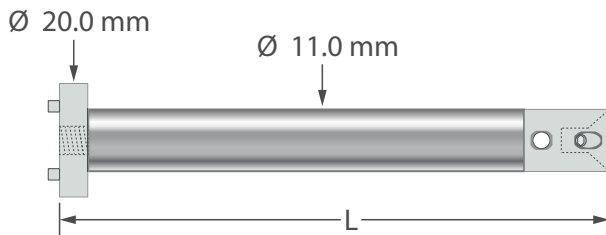

Part Number	L	Wt	Price
VM5-12.70-PF	70.0	15.83	\$225.00
VM5-12.80-PF	80.0	16.55	\$230.00
VM5-12.90-PF	90.0	17.28	\$235.00
VM5-12.110-PF	110.0	18.73	\$245.00
VM5-12.130-PF	130.0	20.18	\$260.00
VM5-12.160-PF	160.0	22.35	\$280.00
VM5-12.180-PF	180.0	23.80	\$295.00
VM5-12.190-PF	190.0	24.53	\$295.00
VM5-12.210-PF	210.0	25.98	\$305.00
VM5-12.240-PF	240.0	30.90	\$330.00
VM5-12.260-PF	260.0	32.35	\$345.00
VM5-12.310-PF	310.0	35.98	\$370.00
VM5-12.410-PF	410.0	43.23	\$440.00

M5 Pro Fit extension with 11.0 mm diameter carbon fiber body, titanium end fittings, and conical end receiver. For use with Pro Fit adapter plate and assembly screw (see below).

M5 Pro Fit assembly screw



Part Number	Wt	Price
SM5-25-PF	4.64	\$10.00

Stainless steel hex head cap screw for assembling Pro Fit extensions with Pro Fit adapter plates.



WARNING: The products on this page can expose you to chemicals including cobalt, nickel, and phenylhydrazine, which are known to the State of California to cause cancer, and bisphenol A (BPA), which is known to the State of California to cause birth defects or other reproductive harm. For more information go to www.p65warnings.ca.gov.

Blum Compatible Parts



M4 carbide stem styli, TC50/51

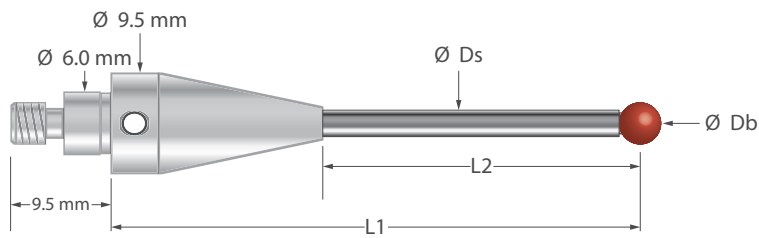

Part Number	Db	Ds	L1	L2	Price
TM4-3051.5-BL-TC50/51	3.0	2.0	50.0	30.0	\$80.00
TM4-4052-BL-TC50/51	4.0	2.5	50.0	30.0	\$80.00
TM4-5052.5-BL-TC50/51	5.0	2.5	50.0	30.0	\$85.00
TM4-6053-BL-TC50/51	6.0	2.5	50.0	30.0	\$95.00
TM4-40102-BL-TC50/51	4.0	2.5	100.0	80.0	\$95.00
TM4-50102.5-BL-TC50/51	5.0	2.5	100.0	80.0	\$100.00
TM4-60103-BL-TC50/51	6.0	2.5	100.0	80.0	\$110.00

M4 stylus with ruby ball, carbide stem, and stainless steel base, for Blum probe systems.

M4 carbide, ceramic, and stainless steel stem styli, TC50/51

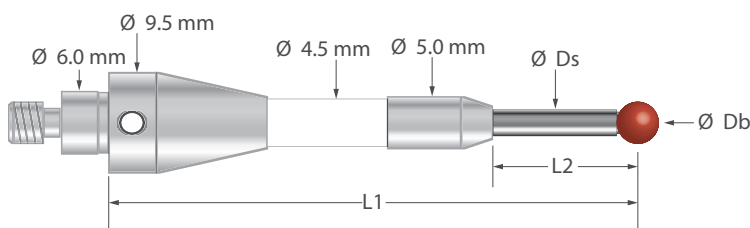

Part Number	Db	Ds	L1	L2	Price
TM4-3051.5-C-BL-TC50/51	3.0	2.0	50.0	10.0	\$185.00
TM4-4052-C-BL-TC50/51	4.0	2.5	50.0	11.0	\$195.00
TM4-5052.5-C-BL-TC50/51	5.0	3.5	50.0	12.0	\$195.00
TM4-20101-C-BL-TC50/51	2.0	1.0	100.0	8.3	\$195.00
TM4-30101.5-C-BL-TC50/51	3.0	2.0	100.0	10.0	\$195.00
TM4-40102-C-BL-TC50/51	4.0	2.5	100.0	11.0	\$195.00
TM4-40152-C-BL-TC50/51	4.0	2.5	150.0	11.0	\$205.00

M4 stylus with ruby ball, carbide stem, ceramic body, and stainless steel base, for Blum probe systems.

M4 stainless steel stem styli, TC50/51

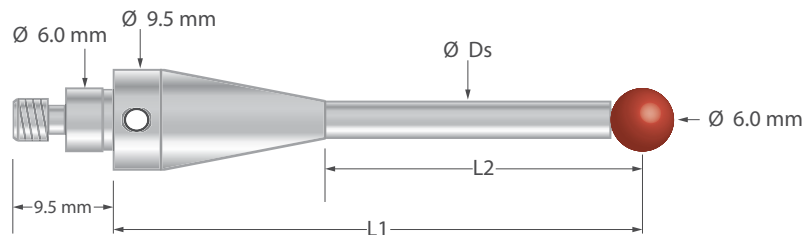

Part Number	Ds	L1	L2	Price
TM4-60103-S-BL-TC50/51	4.5	100.0	75.0	\$90.00
TM4-60153-S-BL-TC50/51	4.5	150.0	125.0	\$105.00

M4 stylus with ruby ball, stainless steel stem and base, for Blum probe systems.

M4 carbide stem styli, TC52/53/54/76

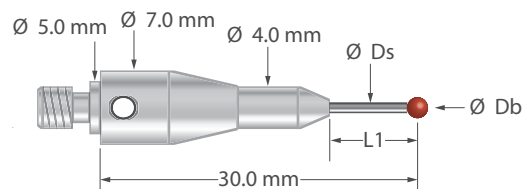

Part Number	Db	Ds	L1	Price
TM4-1030.5-BL-CARB	1.0	0.7	5.1	\$135.00
TM4-2031-BL	2.0	1.0	8.3	\$75.00

M4 stylus with ruby ball, carbide stem, and stainless steel base, for Blum probe systems.

M4 carbide stem styli, TC52/53/54/76

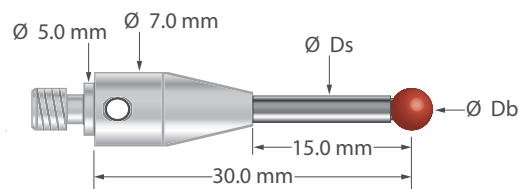

Part Number	Db	Ds	Price
TM4-3031.5-BL	3.0	1.5	\$75.00
TM4-4032-BL	4.0	2.5	\$75.00
TM4-5032.5-BL	5.0	2.5	\$80.00
TM4-6033-BL	6.0	2.5	\$85.00

M4 stylus with ruby ball, carbide stem, and stainless steel base, for Blum probe systems.



WARNING: The products on this page can expose you to chemicals including cobalt, nickel, and phenylhydrazine, which are known to the State of California to cause cancer, and bisphenol A (BPA), which is known to the State of California to cause birth defects or other reproductive harm. For more information go to www.p65warnings.ca.gov.

Blum Compatible Parts



M4 carbide, ceramic, and stainless steel stem styli, TC52/53/54/76

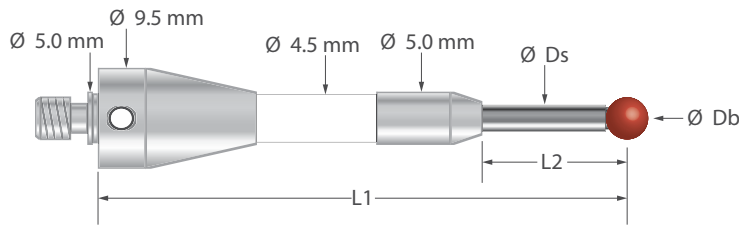

Part Number	Db	Ds	L1	L2	Price
TM4-1050.5-C-BL	1.0	0.7	50.0	5.1	\$185.00
TM4-2051-C-BL	2.0	1.0	50.0	8.0	\$185.00
TM4-3051.5-C-BL	3.0	2.0	50.0	11.8	\$185.00
TM4-4052-C-BL	4.0	2.5	50.0	13.7	\$195.00
TM4-5052.5-C-BL	5.0	3.5	50.0	12.0	\$195.00
TM4-5077.5-C-BL	5.0	3.5	75.0	14.5	\$205.00
TM4-50102.5-C-BL	5.0	3.5	100.0	14.5	\$215.00

M4 stylus with ruby ball, carbide stem, ceramic body, and stainless steel base, for Blum probe systems.

M4 extensions

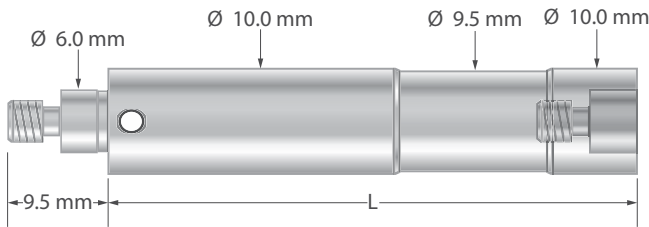

Part Number	L2	Price
VM4-50-BL	50.0	\$45.00
VM4-75-BL	75.0	\$50.00
VM4-100-BL	100.0	\$55.00

M4 extension, stainless steel, for Blum probe systems.

Thread adapter for Blum TC50/51/60

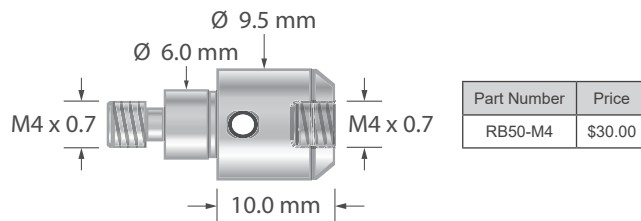

Thread adapter, M4 Blum (TC50/51/60) to standard M4 x 0.7 threads. Stainless steel.

Thread adapter for Blum TC52/62/76

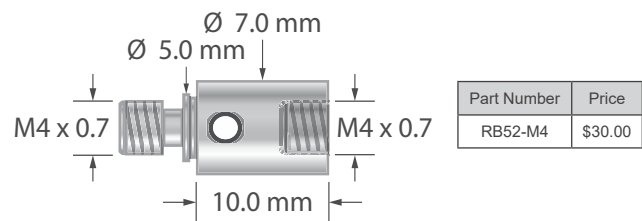

Thread adapter, M4 Blum (TC52/62/76) to standard M4 x 0.7 threads. Stainless steel.



WARNING: The products on this page can expose you to chemicals including cobalt, nickel, and phenylhydrazine, which are known to the State of California to cause cancer, and bisphenol A (BPA), which is known to the State of California to cause birth defects or other reproductive harm. For more information go to www.p65warnings.ca.gov.

Faro Compatible Parts

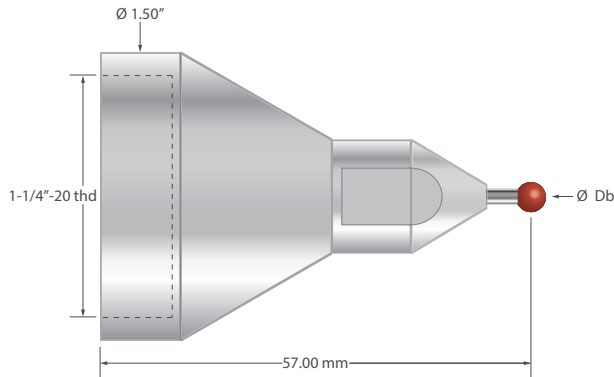

Part Number	Db	Wt	Ruby	Silicon Nitride*	Zirconia**	Carbide***	Steel****
QMFP-2	2.0	102	\$115.00	\$145.00	\$145.00	-	-
QMFP-3	3.0	103	\$120.00	\$150.00	\$150.00	\$195.00	\$125.00
QMFP-3.5	3.5	103	\$120.00	\$150.00	\$150.00	-	-
QMFP-4	4.0	103	\$120.00	\$150.00	\$150.00	-	-
QMFP-5	5.0	104	\$120.00	\$150.00	\$150.00	-	-
QMFP-6	6.0	105	\$120.00	\$150.00	\$150.00	-	-
QMFP-8	8.0	107	\$180.00	\$210.00	\$210.00	-	-

Faro compatible stylus with carbide stem and stainless steel base.

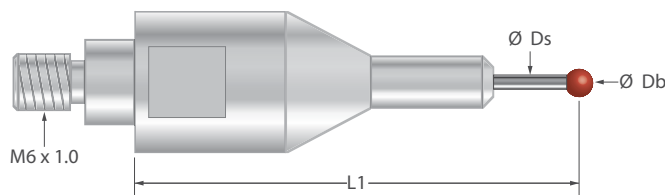

Part Number	Db	Ds	L1	Ruby	Silicon Nitride*	Zirconia**
QMFARO-1/16	1/16"	1.0	44.0	\$125.00	-	\$165.00
QMFARO-1/8	1/8"	2.0	44.0	\$110.00	-	\$140.00
QMFARO-1/4	1/4"	2.5	44.0	\$130.00	-	\$160.00
QMFARO-5/16	5/16"	2.0	44.0	\$145.00	-	\$175.00
QMFARO-15	1.5	1.0	47.05	\$72.00	\$102.00	\$102.00
QMFARO-20	2.0	1.5	47.05	\$75.00	\$105.00	\$105.00
QMFARO-30	3.0	2.0	44.0	\$75.00	\$105.00	\$105.00
QMFARO-40	4.0	2.0	44.0	\$105.00	\$135.00	\$135.00
QMFARO-50	5.0	2.0	44.0	\$105.00	\$135.00	\$135.00
QMFARO-60	6.0	2.0	44.0	\$95.00	\$125.00	\$125.00

Faro compatible stylus with carbide stem and stainless steel base.

Thread adapters and scriber point

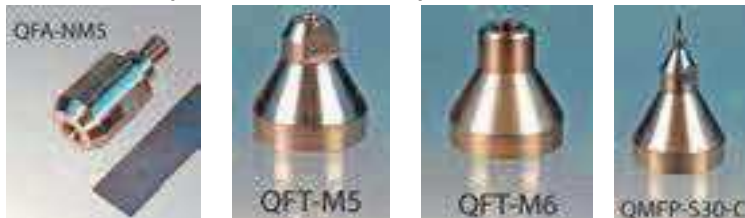

Part Number	Thread Sizes	Price
QFA-NM5	M6 (OD) to M5 (ID)	\$40.00
QFT-M5	1-1/4-20 (ID) to M5 (ID)	\$80.00
QFT-M6	1-1/4-20 (ID) to M6 (ID)	\$80.00
QMFP-S30-C	1-1/4-20 (ID)	\$180.00

Faro thread to metric thread adapters, stainless steel. Scriber has a stainless steel base and 30 degree carbide point.

Right angle stylus

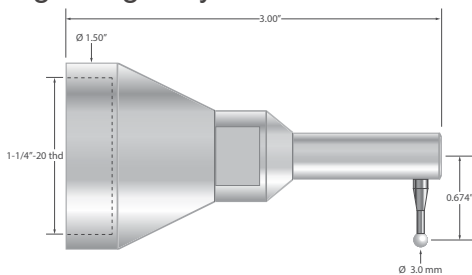

Part Number	Zirconia
QMFP-30-90-Z	\$180.00

Faro compatible right angle stylus with stainless steel base, carbide stem, and 3.0 mm diameter zirconia ball.

*NOTE: For a **silicon nitride** ball, add **-SN** to the part number.

NOTE: For a **zirconia ball, add **-Z** to the part number.

WARNING: The products on this page can expose you to chemicals including cobalt, nickel, and phenylhydrazine, which are known to the State of California to cause cancer, and bisphenol A (BPA), which is known to the State of California to cause birth defects or other reproductive harm. For more information go to www.p65warnings.ca.gov.

Romer Compatible Parts



Romer compatible styli

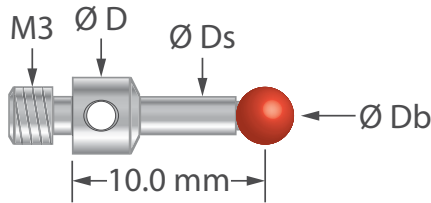

Part Number	Db	Ds	D	Wt	Ruby	Silicon Nitride*	Zirconia**
TM3-2010-S	2.0	1.5	3.5	0.83	\$36.00	\$66.00	\$66.00
TM3-3010-S	3.0	2.0	4.0	0.98	\$40.00	\$70.00	\$70.00
TM3-4010-S	4.0	2.5	4.0	1.04	\$40.00	\$70.00	\$70.00
TM3-5010-S	5.0	2.5	4.0	1.20	\$45.00	\$75.00	\$75.00
TM3-6010-S	6.0	2.5	4.0	1.35	\$45.00	\$75.00	\$75.00
TM3-8010-S	8.0	4.0	4.0	2.20	\$80.00	\$110.00	\$110.00

Romer compatible styli with stainless steel base and stem.

Romer compatible scriber

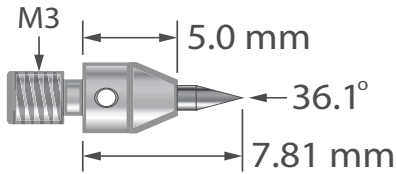

Part Number	Price
TM3-S30R-C	\$65.00

Romer compatible scriber with stainless steel base and carbide point.



WARNING: The products on this page can expose you to chemicals including cobalt, nickel, and phenylhydrazine, which are known to the State of California to cause cancer, and bisphenol A (BPA), which is known to the State of California to cause birth defects or other reproductive harm. For more information go to www.p65warnings.ca.gov.

Adapter Plates and accessories



Adapter plates for M3 styli

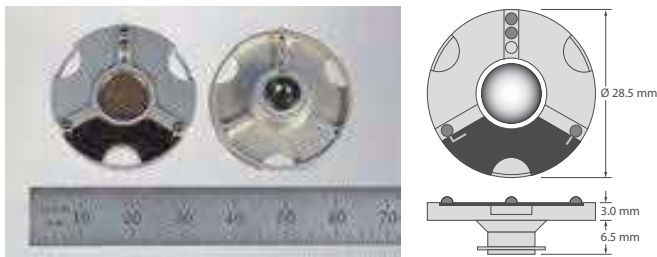

M3 adapter plate, aluminum, with ID chip. Fits TL1 probe head.

Part Number	Wt	Price
XXT-AP-ID	4.59	\$350.00

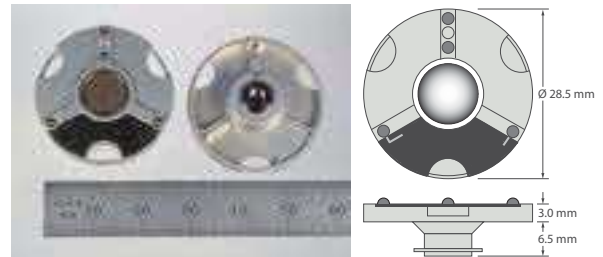

M3 adapter plate, aluminum, with ID chip. Fits TL3 probe head.

Part Number	Wt	Price
XXT-AP-ID3	4.59	\$350.00



M3 adapter plate, Delrin®, with ID chip for XXT-ID TL1 or TL3. Light weight design.

Part Number	Fits	Wt	Price
XXT-AP-ID-D	TL1	3.28	\$410.00
XXT-AP-ID3-D	TL3	3.28	\$410.00

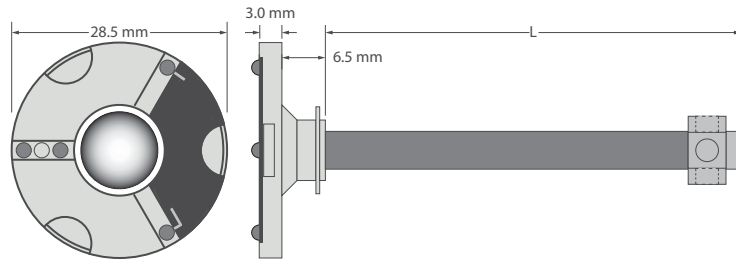

M3 adapter plate, aluminum, with 5.0 mm diameter carbon fiber extension and titanium M3 end fitting. TL1 is available in 55.0 mm length only.

Part Number	Fits	L	Wt	Price
XXT-AP-ID-STR	TL1	55.0	6.90	\$450.00
XXT-AP-ID3-STR	TL3	55.0	6.90	\$450.00
XXT-AP-ID3-STR-75	TL3	75.0	7.50	\$495.00
XXT-AP-ID3-STR-100	TL3	100.0	8.25	\$495.00
XXT-AP-ID3-STR-125	TL3	125.0	8.98	\$495.00
XXT-AP-ID3-STR-150	TL3	150.0	9.73	\$550.00



M3 adapter plate, aluminum, with 4.0 mm diameter carbon fiber extension and stainless steel M3 end fitting.

Part Number	Wt	Price
RADP25-2	4.10	\$295.00



M3 adapter plate, aluminum, clamping, for X1c and X1h.

Part Number	Wt	Price
LSP-209-X1	6.88	\$395.00



Stylus change port for clamping adapter plate LSP-209-X1.

Part Number	Price
CP-X1	\$295.00



WARNING: The products on this page can expose you to chemicals including cobalt, nickel, and phenylhydrazine, which are known to the State of California to cause cancer, and bisphenol A (BPA), which is known to the State of California to cause birth defects or other reproductive harm. For more information go to www.p65warnings.ca.gov.

Adapter Plates and accessories



Adapter plates for M5 components



Part Number	Wt	Price
VAS-1054	140.86	\$304.00

M5 adapter plate for VAST probe system with hard anodized aluminum cube and ID chip. 69.0 mm diameter.



Part Number	Wt	Price
VAS-8574	143.37	\$300.00

M5 adapter plate for VAST probe system with hard anodized aluminum cube. No ID chip. 69.0 mm diameter.



Part Number	Wt	Price
VAS-XT-9010	149.45	\$300.00

M5 adapter plate for VAST-XT probe system. 69.0 mm diameter.



Part Number	Wt	Price
VAS-XT-9010-C	143.27	\$300.00

M5 adapter plate for VAST-XT probe system with hard anodized aluminum cube. 69.0 mm diameter.



Part Number	Wt	Price
VAS-9116	169.93	\$310.00

M5 adapter plate with titanium plate and 32.5 mm offset M5 tapped hole. Used on gear checking machines with VAST probe heads.



WARNING: The products on this page can expose you to chemicals including cobalt, nickel, and phenylhydrazine, which are known to the State of California to cause cancer, and bisphenol A (BPA), which is known to the State of California to cause birth defects or other reproductive harm. For more information go to www.p65warnings.ca.gov.

Adapter Plates and accessories



Adapter plates for M5 Pro Fit components



Part Number	Wt	Price
VAS-1054-PF	154.13	\$695.00

M5 adapter plate with ID chip and single Pro Fit cube for VAST probe system. 69.0 mm diameter.



Part Number	Wt	Price
VAS-1054-PF-40	186.71	\$795.00

M5 adapter plate with ID chip and double Pro Fit cube for VAST probe system. 69.0 mm diameter.



Part Number	Wt	Price
VAS-1054-50-PF	157.61	\$915.00

M5 adapter plate ID chip and single Pro Fit cube for VAST probe system. Includes 20.0 mm diameter x 50.0 mm long Therm-X extension.

Adapter plate for Klingelberg



Part Number	Wt	Price
KGMC-2000	63.73	\$250.00

M5 adapter plate for Klingelberg P26 and P40 gear measurement systems.

Probe bay for VAST adapter plates



Part Number	Quantity	Price
VAS-BAY	One	\$290.00

Holds one VAST adapter plate. Mounting hardware included.



WARNING: The products on this page can expose you to chemicals including cobalt, nickel, and phenylhydrazine, which are known to the State of California to cause cancer, and bisphenol A (BPA), which is known to the State of California to cause birth defects or other reproductive harm. For more information go to www.p65warnings.ca.gov.

Adapter Plates and accessories



Probe bay for XXT adapter plates



Part Number	Quantity	Price
PS-XXT	One	\$1,150.00
PS-XXT-3	Three	\$3,105.00

Each bay holds up to three XXT adapter plates. Mounting hardware included.

Two-level rack for VAST, RDS, and XXT probe bays



Part Number	Price
PCM-MINI	\$750.00

Two-level probe change rack for VAST, RDS, and XXT probe bays. Bolts to CMM table with stainless steel cap screw (included). 720 mm wide by 450 mm tall. Probe bays sold separately.

Cube Squared™



Part Number	Quantity	Price
QM-C2	One	\$195.00

Squares VAST and VAST-XT adapter plates to the CMM axis in one minute or less. No other tools needed.

Cube Squared Plus™



Part Number	Quantity	Price
QM-C2P	One	\$245.00

Sets VAST and VAST-XT plates to any angle to the CMM axis in one minute or less. No other tools needed.



WARNING: The products on this page can expose you to chemicals including cobalt, nickel, and phenylhydrazine, which are known to the State of California to cause cancer, and bisphenol A (BPA), which is known to the State of California to cause birth defects or other reproductive harm. For more information go to www.p65warnings.ca.gov.

Calibration Spheres



Grade 5 ruby calibration sphere



Part Number	Sphere Diameter (mm)	Price
CAL-DK5	5.0	\$525.00

Grade 5 ruby calibration sphere mounted on M6 threaded blackened stainless steel base. Independent laboratory certifications included.

Grade 5 ceramic calibration spheres



Part Number	Sphere Diameter (mm)	Price
CAL-DK8-C	8.0	\$445.00
CAL-DK12-C	12.0	\$790.00
CAL-DK14	14.0	\$795.00
CAL-DK15	15.0	\$560.00
CAL-DK20	20.0	\$625.00
CAL-DK25	25.0	\$595.00
CAL-DK25.4	25.4	\$675.00
CAL-DK30	30.0	\$620.00

Grade 5 ceramic calibration spheres mounted on M6 threaded blackened stainless steel bases. Independent laboratory certs included.

Base and stand for one calibration sphere



Part Number	Price
CAL-DKMB	\$180.00

Black powder-coated stainless steel base and stand for one calibration sphere. Base diameter is 85.0 mm with 112.0 mm tall post. Accepts calibration spheres with M6 threaded bases. A stainless steel M12 cap screw is included for fastening to CMM table, and a 1/4-20 cap screw is included for mounting to threaded subplates. Calibration sphere sold separately.

Base and stand for two calibration spheres



Part Number	Price
CAL-DKMB-DE	\$230.00

Black powder-coated stainless steel base and stand for two calibration spheres. Base diameter is 85.0 mm with 112.0 mm tall post. Accepts calibration spheres with M6 threaded bases. A stainless steel M12 cap screw is included for fastening to CMM table, and a 1/4-20 cap screw is included for mounting to a threaded subplate. Calibration spheres sold separately.



WARNING: The products on this page can expose you to chemicals including cobalt, nickel, and phenylhydrazine, which are known to the State of California to cause cancer, and bisphenol A (BPA), which is known to the State of California to cause birth defects or other reproductive harm. For more information go to www.p65warnings.ca.gov.

Thread Adapters and accessories



M2 to other

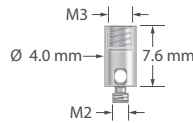

Part Number	Wt	Price
RM2-M3	0.49	\$11.00

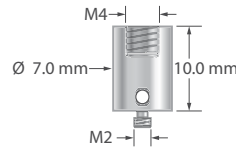

Part Number	Wt	Price
RM2-M4	1.61	\$15.00

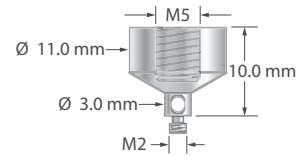

Part Number	Wt	Price
RM2-M5	3.94	\$15.00

Stainless steel.

M3 to other

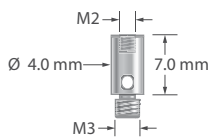

Part Number	Wt	Price
RM3-M2	0.63	\$11.00

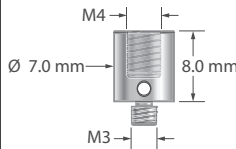

Part Number	Wt	Price
RM3-M4	1.92	\$17.00

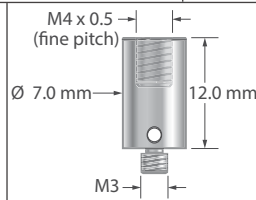

Part Number	Wt	Price
RM3-M4-DEA	2.77	\$17.00

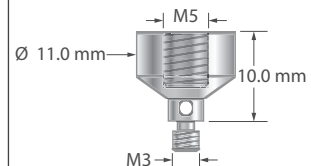

Part Number	Wt	Price
RM3-M5	3.73	\$15.00

Stainless steel.

M4 to other

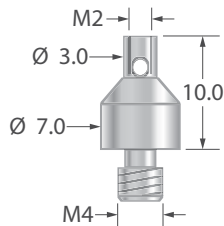

Part Number	Wt	Price
RM4-M2	1.88	\$18.00

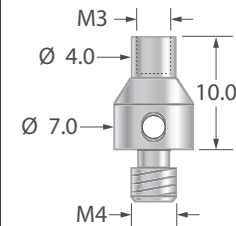

Part Number	Wt	Price
RM4-M3	1.72	\$18.00

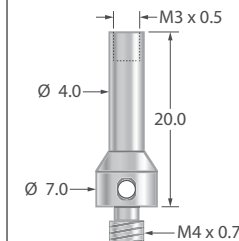

Part Number	Wt	Price
RM4-M3-L	2.71	\$18.00

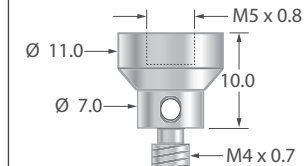

Part Number	Wt	Price
RM4-M5	4.50	\$18.00

Stainless steel.

M4 to M3, with ceramic body

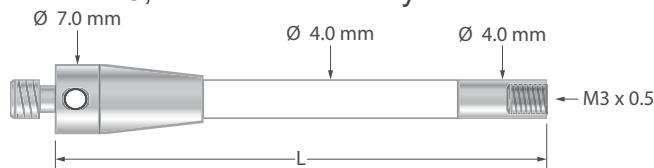

Part Number	L	Wt	Price
RM4-50-M3-C	50.0	4.36	\$59.00
RM4-75-M3-C	75.0	5.18	\$90.00
RM4-100-M3-C	100.0	6.27	\$103.00

M4 to M3 thread adapter, ceramic, with stainless steel end fittings.

M4 to M3, with carbon fiber body

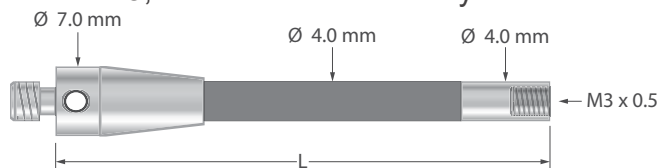

Part Number	L	Wt	Price
RM4-50-M3-G	50.0	3.49	\$95.00
RM4-75-M3-G	75.0	4.14	\$95.00
RM4-100-M3-G	100.0	5.02	\$110.00

M4 to M3 thread adapter, carbon fiber, with stainless steel end fittings.



WARNING: The products on this page can expose you to chemicals including cobalt, nickel, and phenylhydrazine, which are known to the State of California to cause cancer, and bisphenol A (BPA), which is known to the State of California to cause birth defects or other reproductive harm. For more information go to www.p65warnings.ca.gov.

Thread Adapters and accessories



M5 to other

Part Number	Wt	Price
RM5-M2	3.88	\$15.00

Part Number	Wt	Price
RM5-M3	3.64	\$15.00

Part Number	Wt	Price
RM5-M4	5.79	\$15.00

Part Number	Wt	Price
RM5-4-48	3.62	\$15.00

Stainless steel.

Probe keys, golf tee style



Hardened and tempered tool steel with black oxide finish.

Part Number	Fits	Price
PK2-PK3	M2 & M3	\$8.00
PK-3-R	M3 Romer	\$15.00
PK-4-GT	M4	\$11.00
PK-5-GT	M5	\$14.00

Probe keys, offset style



Hardened and tempered tool steel with stainless steel handle.

Part Number	Fits	Price
PK-2	M2	\$12.00
PK-3	M3	\$12.00
PK-4	M4	\$6.00
PK-5	M5	\$14.00

Thread card



End the guesswork over the correct thread and ball sizes for your probe systems. Our exclusive thread card has ten different tapped holes between M2 and 3/8-24 UNF to check thread sizes, and ten holes from 1.0 mm to 6.0 mm diameter to gage ball sizes. A built-in 40.0 mm long scale is helpful for estimating probe lengths.

We make these from aircraft-grade aluminum. They are machined, red anodized, and laser engraved. About the size of a playing card, they are approximately 75.0 mm long x 50.0 mm wide x 3.0 mm thick.

A protective slip cover (shown) is included.

Part Number	Price
Thread Card	\$25.00

WARNING: The products on this page can expose you to chemicals including cobalt, nickel, and phenylhydrazine, which are known to the State of California to cause cancer, and bisphenol A (BPA), which is known to the State of California to cause birth defects or other reproductive harm. For more information go to www.p65warnings.ca.gov.

Unthreaded Styli



0.2 mm ruby ball with 1.0 mm stem

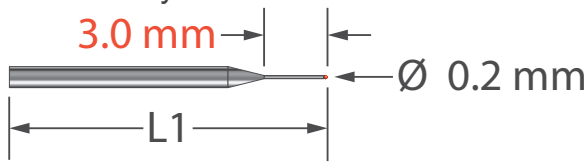

Part Number	L1	Wt	Price
TST-0210-R	10.0	0.09	\$145.00
TST-0215-R	15.0	0.14	\$145.00
TST-0225-R	25.0	0.21	\$145.00

Unthreaded styli with 0.2 mm diameter ruby ball and tapered carbide stem. Minor stem diameter is 0.15 mm and major stem diameter is 1.0 mm.

0.3 mm carbide ball with 1.0 mm stem

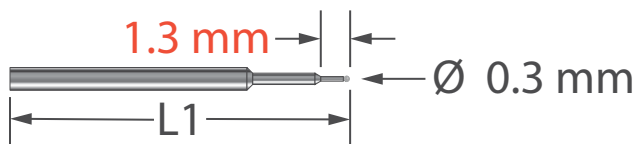

Part Number	L1	Wt	Price
TST-0310-C	10.0	0.11	\$110.00
TST-0315-C	15.0	0.17	\$110.00
TST-0316.5-C	16.5	0.18	\$110.00
TST-0325-C	25.0	0.28	\$110.00

Unthreaded styli with 0.3 mm diameter carbide ball and stepped carbide stem. Minor stem diameter is 0.2 mm, intermediate diameter is 0.5 mm, and major stem diameter is 1.0 mm.

0.3 mm ruby ball with 1.0 mm stem

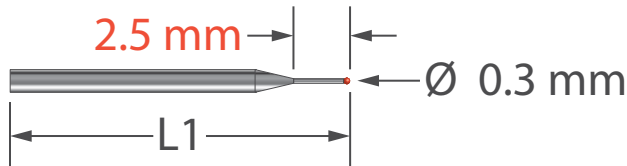

Part Number	L1	Wt	Price
TST-0308-R	8.0	0.07	\$110.00
TST-0310-R	10.0	0.09	\$110.00
TST-0315-R	15.0	0.13	\$110.00
TST-0315.3-R	15.3	0.14	\$55.00

Unthreaded styli with 0.3 mm diameter ruby ball and tapered carbide stem. Minor stem diameter is 0.2 mm and major diameter is 1.0 mm.

0.4 mm carbide ball with 1.0 mm stem

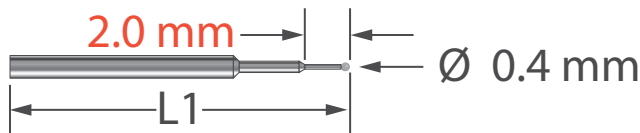

Part Number	L1	Wt	Price
TST-0415-C	15.0	0.15	\$105.00
TST-0425-C	25.0	0.23	\$105.00

Unthreaded styli with 0.4 mm diameter carbide ball and stepped carbide stem. Minor stem diameter is 0.25 mm, intermediate diameter is 0.5 mm, and major stem diameter is 1.0 mm.

0.4 mm ruby or silicon nitride ball with 1.0 mm stem

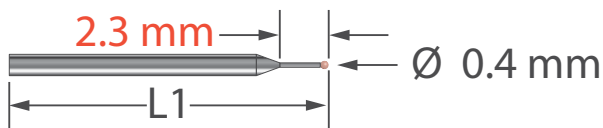

Part Number	L1	Wt	Ruby	Silicon Nitride*
TST-0415	15.0	0.15	\$115.00	\$145.00
TST-0425	25.0	0.23	\$120.00	\$150.00

Unthreaded styli with 0.4 mm diameter ruby or silicon nitride ball and tapered carbide stem. Minor stem diameter is 0.30 mm and major stem diameter is 1.0 mm.

0.5 mm carbide ball with 1.0 mm stem

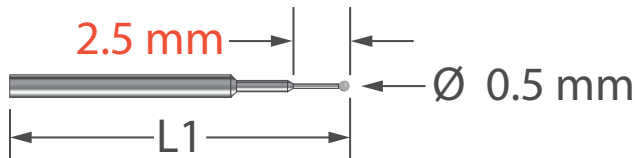

Part Number	L1	Wt	Price
TST-0515-C	15.0	0.17	\$95.00
TST-0525-C	25.0	0.28	\$95.00

Unthreaded styli with 0.5 mm diameter carbide ball and stepped carbide stem. Minor stem diameter is 0.30 mm, intermediate diameter is 0.5 mm, and major stem diameter is 1.0 mm.

*NOTE: For a **silicon nitride** ball, add **-SN** to the part number.

NOTE: For a **carbide ball, add **-C** to the part number.



WARNING: The products on this page can expose you to chemicals including cobalt, nickel, and phenylhydrazine, which are known to the State of California to cause cancer, and bisphenol A (BPA), which is known to the State of California to cause birth defects or other reproductive harm. For more information go to www.p65warnings.ca.gov.

Unthreaded Styli



0.5 mm ruby or silicon nitride ball with 1.0 mm stem

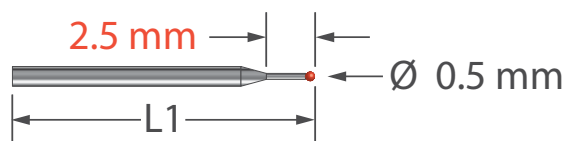

Part Number	L1	Wt	Ruby	Silicon Nitride*
TST-0510-R	10.0	0.11	\$90.00	\$120.00
TST-0515-R	15.0	0.14	\$90.00	\$120.00
TST-0515.5-R	15.5	0.15	\$52.00	\$82.00
TST-0525-R	25.0	0.24	\$95.00	\$125.00

Unthreaded styli with 0.5 mm diameter ruby or silicon nitride ball and tapered carbide stem. Minor stem diameter is 0.3 mm and major diameter is 1.0 mm.

0.6 mm ball with 1.0 mm stem

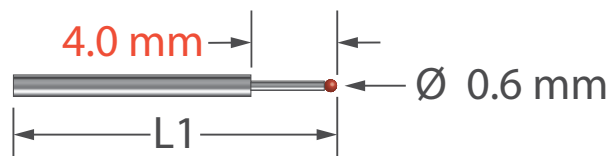

Part Number	L1	Wt	Ruby	Silicon Nitride*	Carbide**	Zirconia***
TST-0610	10.0	0.09	\$70.00	\$100.00	\$70.00	\$100.00
TST-0615	15.0	0.13	\$70.00	\$100.00	\$70.00	\$100.00
TST-0615.5	16.5	0.14	\$41.00	\$71.00	\$41.00	\$71.00
TST-0620	20.0	0.21	\$70.00	\$100.00	\$70.00	\$100.00
TST-0625	25.0	0.29	\$70.00	\$100.00	\$70.00	\$100.00

Unthreaded styli with 0.6 mm diameter ball and carbide stem. Minor stem diameter is 0.4 mm and major diameter is 1.0 mm.

0.7 mm ruby ball with 1.0 mm stem

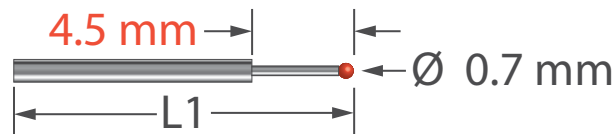

Part Number	L1	Wt	Price
TST-0715	15.0	0.15	\$44.00

Unthreaded styli with 0.7 mm diameter ruby ball and stepped carbide stem. Minor stem diameter is 0.5 mm and major diameter is 1.0 mm.

0.8 mm ball with 1.0 mm stepped stem

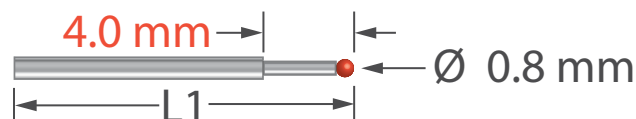

Part Number	L1	Wt	Ruby	Silicon Nitride*	Carbide**	Zirconia***
TST-0810	10.0	0.07	\$55.00	\$85.00	\$77.00	\$85.00
TST-0815	15.0	0.14	\$39.00	\$69.00	\$75.00	\$69.00
TST-0820	20.0	0.18	\$55.00	\$85.00	\$77.00	\$85.00
TST-0825	25.0	0.24	\$60.00	\$90.00	\$82.00	\$90.00

Unthreaded styli with 0.8 mm diameter ball and stepped carbide stem. Minor stem diameter is 0.6 mm and major diameter is 1.0 mm.

0.8 mm ball with 1.0 mm tapered stem

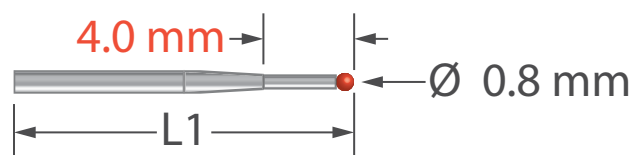

Part Number	L1	Wt	Ruby	Silicon Nitride*	Carbide**	Zirconia***
TST-0810-T	10.0	0.07	\$55.00	\$85.00	\$77.00	\$85.00
TST-0815-T	15.0	0.14	\$39.00	\$69.00	\$61.00	\$69.00
TST-0820-T	20.0	0.18	\$55.00	\$85.00	\$77.00	\$85.00
TST-0825-T	25.0	0.24	\$60.00	\$90.00	\$82.00	\$90.00

Unthreaded styli with 0.8 mm diameter ball and stepped carbide stem. Minor stem diameter is 0.6 mm and major diameter is 1.0 mm.

1.0 mm ball with 0.7 mm stem

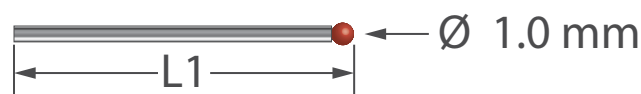

Part Number	L1	Wt	Ruby	Silicon Nitride*	Zirconia***
TST-1010-DS.7	10.0	0.06	\$39.00	\$69.00	\$69.00
TST-1015-DS.7	15.0	0.08	\$39.00	\$69.00	\$69.00

Unthreaded styli with 1.0 mm diameter ball and 0.7 mm diameter carbide stem.

*NOTE: For a **silicon nitride** ball, add **-SN** to the part number.

NOTE: For a **carbide ball, add **-C** to the part number.

***NOTE: For a **zirconia** ball, add **-Z** to the part number.



WARNING: The products on this page can expose you to chemicals including cobalt, nickel, and phenylhydrazine, which are known to the State of California to cause cancer, and bisphenol A (BPA), which is known to the State of California to cause birth defects or other reproductive harm. For more information go to www.p65warnings.ca.gov.

Unthreaded Styli



1.0 mm ball with 1.0 mm stepped stem

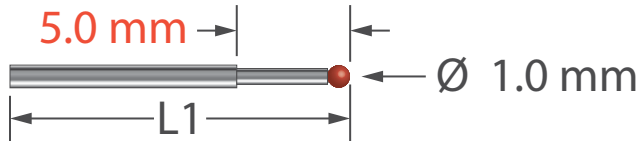

Part Number	L1	Wt	Ruby	Silicon Nitride*	Zirconia**
TST-1010	10.0	0.11	\$39.00	\$69.00	\$69.00
TST-1015	15.0	0.16	\$39.00	\$69.00	\$69.00
TST-1016	16.0	0.17	\$39.00	\$69.00	\$69.00
TST-1020	20.0	0.21	\$39.00	\$69.00	\$69.00
TST-1025	25.0	0.26	\$39.00	\$69.00	\$69.00
TST-1030	30.0	0.31	\$42.00	\$72.00	\$72.00
TST-1035	35.0	0.36	\$42.00	\$72.00	\$72.00
TST-1040	40.0	0.41	\$43.00	\$73.00	\$73.00

Unthreaded styli with 1.0 mm diameter ball and stepped carbide stem. Minor stem diameter is 0.7 mm and major diameter is 1.0 mm.

1.35 mm ball with 1.0 stem

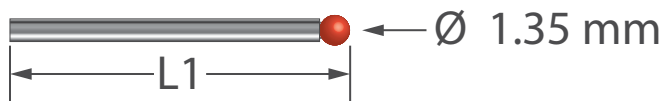

Part Number	L1	Wt	Ruby	Silicon Nitride*
TST-1308	8.0	0.08	\$35.00	\$65.00
TST-1315	15.0	0.16	\$35.00	\$65.00
TST-1320	20.0	0.21	\$35.00	\$65.00
TST-1325	25.0	0.26	\$35.00	\$65.00
TST-1335	35.0	0.36	\$42.00	\$72.00

Unthreaded styli with 1.35 mm diameter ball and 1.0 mm diameter carbide stem.

1.5 mm ball with 1.0 stem

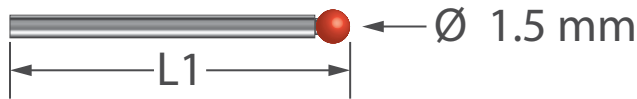

Part Number	L1	Wt	Ruby	Silicon Nitride*	Zirconia**
TST-1508	8.0	0.08	\$35.00	\$65.00	\$65.00
TST-1515	15.0	0.16	\$35.00	\$65.00	\$65.00
TST-1520	20.0	0.21	\$35.00	\$65.00	\$65.00
TST-1525	25.0	0.26	\$35.00	\$59.00	\$65.00
TST-1526.5	26.5	0.28	\$39.00	\$69.00	\$69.00
TST-1530	30.0	0.32	\$39.00	\$69.00	\$69.00
TST-1535	35.0	0.36	\$39.00	\$69.00	\$69.00
TST-1540	40.0	0.41	\$42.00	\$72.00	\$72.00
TST-1550	50.0	0.52	\$45.00	\$75.00	\$75.00

Unthreaded styli with 1.5 mm diameter ball and 1.0 mm diameter carbide stem.

2.0 mm ball with 1.5 stem

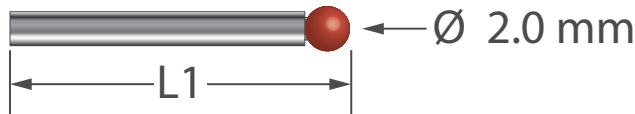

Part Number	L1	Wt	Ruby	Silicon Nitride*	Zirconia**
TST-2015	15.0	0.40	\$35.00	\$65.00	\$65.00
TST-2025	25.0	0.67	\$35.00	\$65.00	\$65.00
TST-2030	30.0	0.80	\$39.00	\$69.00	\$69.00
TST-2035	35.0	0.93	\$39.00	\$69.00	\$69.00
TST-2040	40.0	1.07	\$39.00	\$69.00	\$69.00

Unthreaded styli with 2.0 mm diameter ball and 1.5 mm diameter carbide stem.

2.5 mm ball with 1.5 stem

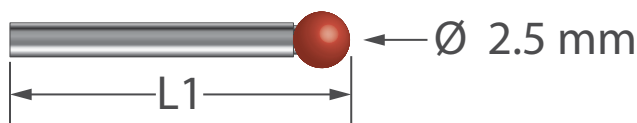

Part Number	L1	Wt	Ruby	Silicon Nitride*	Zirconia**
TST-2525	25.0	0.67	\$35.00	\$65.00	\$65.00
TST-2530	30.0	0.81	\$35.00	\$65.00	\$65.00

Unthreaded styli with 2.5 mm diameter ball and 1.5 mm diameter carbide stem.

*NOTE: For a **silicon nitride** ball, add **-SN** to the part number.

NOTE: For a **zirconia ball, add **-Z** to the part number.



WARNING: The products on this page can expose you to chemicals including cobalt, nickel, and phenylhydrazine, which are known to the State of California to cause cancer, and bisphenol A (BPA), which is known to the State of California to cause birth defects or other reproductive harm. For more information go to www.p65warnings.ca.gov.

Unthreaded Styli



3.0 mm ball with 1.5 stem

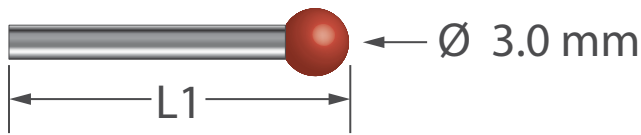

Part Number	L1	Wt	Ruby	Silicon Nitride*	Zirconia**
TST-3025	25.0	0.67	\$35.00	\$65.00	\$65.00
TST-3030	30.0	0.80	\$35.00	\$65.00	\$65.00

Unthreaded styli with 3.0 mm diameter ball and 1.5 mm diameter carbide stem.

3.0 mm ball with 2.0 stem

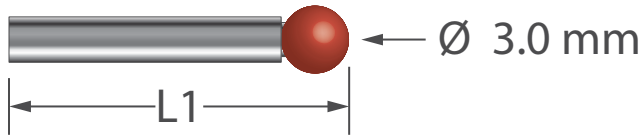

Part Number	L1	Wt	Ruby	Silicon Nitride*	Zirconia**
TST-3035	35.0	1.58	\$37.00	\$67.00	\$67.00
TST-3040	40.0	1.80	\$39.00	\$69.00	\$69.00
TST-3045	45.0	2.02	\$39.00	\$69.00	\$69.00

Unthreaded styli with 3.0 mm diameter ball and 2.0 mm diameter carbide stem.

3.5 mm ball with 1.5 stem

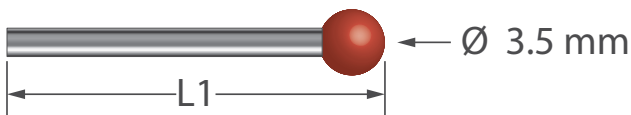

Part Number	L1	Wt	Ruby	Silicon Nitride*
TST-3540	40.0	0.96	\$42.00	\$72.00

Unthreaded styli with 3.5 mm diameter ball and 1.5 mm diameter carbide stem.

4.0 mm ball with 2.0 stem

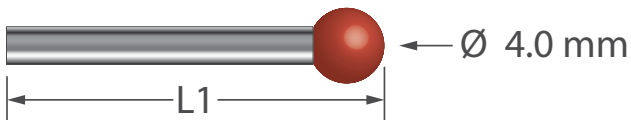

Part Number	L1	Wt	Ruby	Silicon Nitride*	Zirconia**
TST-4030	30.0	1.42	\$42.00	\$72.00	\$72.00

Unthreaded styli with 4.0 mm diameter ball and 2.0 mm diameter carbide stem.

5.0 mm ball with 2.0 stem

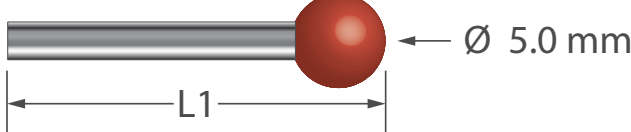

Part Number	L1	Wt	Ruby	Silicon Nitride*	Zirconia**
TST-5055	55.0	2.60	\$42.00	\$72.00	\$72.00

Unthreaded styli with 5.0 mm diameter ball and 2.0 mm diameter carbide stem.

*NOTE: For a **silicon nitride** ball, add **-SN** to the part number.

NOTE: For a **zirconia ball, add **-Z** to the part number.

WARNING: The products on this page can expose you to chemicals including cobalt, nickel, and phenylhydrazine, which are known to the State of California to cause cancer, and bisphenol A (BPA), which is known to the State of California to cause birth defects or other reproductive harm. For more information go to www.p65warnings.ca.gov.

Unthreaded Stylus Holders



M2 ultra-light threaded stylus holder, right angle, for one unthreaded stylus

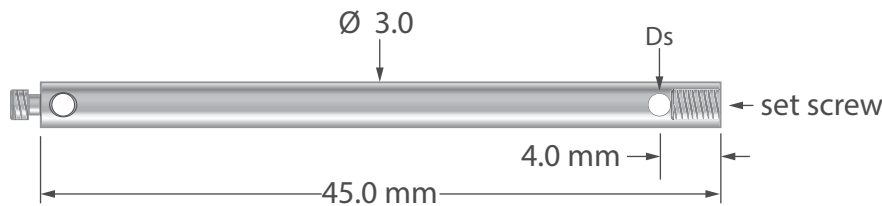

Part Number	Ds	Wt	Price
PH2-10	1.0	2.42	\$45.00
PH2-15	1.5	2.39	\$45.00

M2 ultra-light right angle stylus holder, 3.0 mm diameter stainless steel. Holds one unthreaded stylus at 90 degrees from body. Stainless steel set screw for clamping. Includes one 0.7 mm hex wrench for set screw.

M3 ultra-light threaded stylus holder, right angle, for one unthreaded stylus

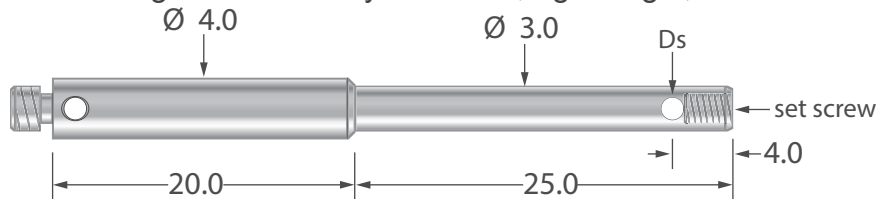

Part Number	Ds	Wt	Price
PH3-10	1.0	3.30	\$45.00
PH3-15	1.5	3.26	\$45.00

M3 ultra-light right angle stylus holder, 4.0 mm diameter stainless steel. Holds one unthreaded stylus at 90 degrees from body. Stainless steel set screw for clamping. Includes one 0.7 mm hex wrench for set screw.

M5 threaded stylus holder, right angle, for one unthreaded stylus

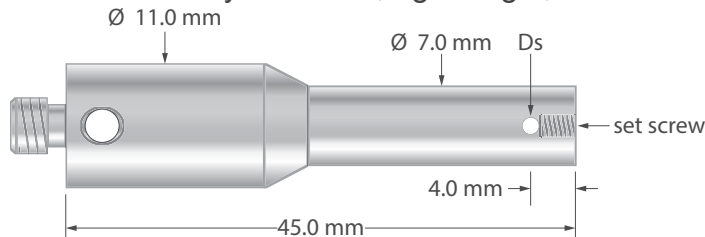

Part Number	Ds	Wt	Price
PH-10	1.0	21.73	\$50.00
PH-15	1.5	21.86	\$50.00

M5 right angle stylus holder, 11.0 mm diameter stainless steel. Holds one unthreaded stylus at 90 degrees from body. Stainless steel set screw for clamping. Includes one 0.7 mm hex wrench for set screw.

M5 threaded stylus holder for one unthreaded stylus

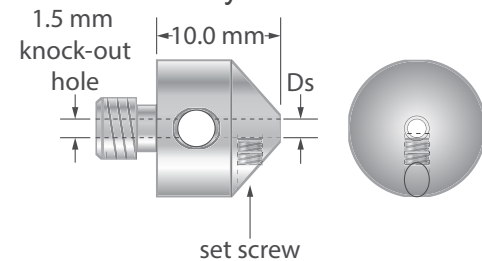

Part Number	Ds	Wt	Price
QC-100	1.0	5.19	\$30.00
QC-150	1.5	4.92	\$30.00
QC-200	2.0	4.47	\$30.00

Holds one unthreaded stylus. Features a 1.5 mm diameter knock-out hole through the threaded base. 11.0 mm diameter stainless steel, with stainless steel set screw. Includes one 0.7 mm hex wrench for set screw.

M5 threaded stylus holder for one to five unthreaded styli in star configuration

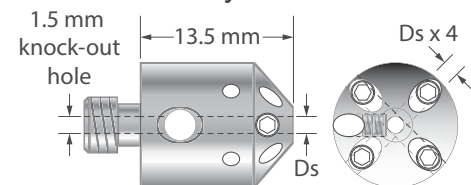

Part Number	Ds	Wt	Price
PH-100	1.0	7.46	\$46.00
PH-150	1.5	7.38	\$46.00
PH-200	2.0	7.28	\$46.00

Holds up to five unthreaded styli. Features a 1.5 mm diameter knock-out hole through the threaded base. 11.0 mm diameter stainless steel, with five stainless steel set screws. Includes one 0.7 mm hex wrench for set screws.



WARNING: The products on this page can expose you to chemicals including cobalt, nickel, and phenylhydrazine, which are known to the State of California to cause cancer, and bisphenol A (BPA), which is known to the State of California to cause birth defects or other reproductive harm. For more information go to www.p65warnings.ca.gov.

Diamond Styli



M3 diamond styli with standard base

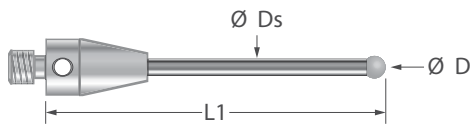

Part Number	D	L1	Ds	Wt	Solid Diamond	Diamond Coated
TM3-2030-TX-D	2.0	30.0	1.5	1.01	\$1,070.00	---
TM3-2030-TX-DC	2.05	30.0	1.5	1.01	---	\$695.00

M3 stylus with solid diamond or diamond coated sphere, carbide stem, and 4.0 mm diameter x 9.0 mm long stainless steel base.

M5 diamond styli with standard base

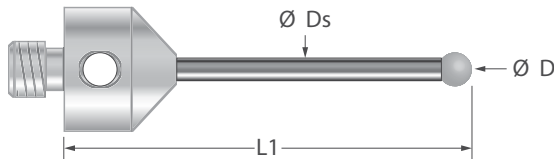

Part Number	D	L1	Ds	Wt	Solid Diamond	Diamond Coated
AFG-1022.5-DS.8-D	1.0	22.5	0.8	5.56	\$1,070.00	---
AFG-2020-DS1.5-D	1.5	20.0	1.5	5.74	\$1,070.00	---
AFG-2034-DC	2.05	34.0	1.5	6.63	---	\$695.00
AFG-2058-D	2.0	58.0	1.5	6.88	\$1,070.00	---
ATG-3025-D	3.0	25.0	1.5	6.01	\$1,070.00	---
ATG-3033-D	3.0	33.0	2.0	6.75	\$1,070.00	---
ATG-3033-DC	3.05	33.0	2.0	6.75	---	\$695.00
ATG-3036-D	3.0	36.0	2.0	6.88	\$1,070.00	---
ATG-3040-DC	3.0	40.0	2.0	7.06	---	\$695.00
ATG-3050-D	3.0	50.0	2.0	7.50	\$1,070.00	---
ATG-3050-DC	3.05	50.0	2.0	7.50	---	\$695.00
ATG-3058-D	3.0	58.0	2.0	7.86	\$1,070.00	---
ATG-3058-DC	3.05	58.0	2.0	7.86	---	\$695.00
ATG-3064-D	3.0	64.0	2.0	8.12	\$1,070.00	---
ATG-3064-DC	3.05	64.0	2.0	8.12	---	\$695.00
ATG-3075-D	3.0	75.0	2.0	8.62	\$1,070.00	---
ATG-3075-DC	3.05	75.0	2.0	8.62	---	\$695.00
ATG-3085-DC	3.05	85.0	2.0	9.07	---	\$695.00
ATG-3090-D	3.0	90.0	2.0	9.29	\$1,070.00	---
ATG-30100-DC	3.05	100.0	2.0	9.73	---	\$695.00
ATG-5050-DC	5.05	50.0	3.5	11.18	---	\$950.00
ATG-5075-DC	5.05	75.0	3.5	14.64	---	\$950.00
ATG-50100-DC	5.05	100.0	3.5	17.82	---	\$950.00

M5 stylus with solid diamond or diamond coated sphere, carbide stem, and 11.0 mm diameter x 10.0 mm long stainless steel base.

M5 diamond styli with stepped base

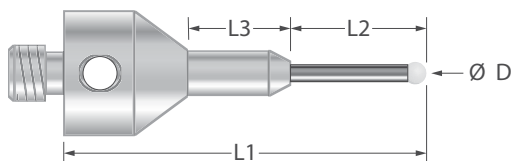

Part Number	D	L1	L2	L3	Wt	Solid Diamond	Diamond Coated
AQG-2032-D	2.0	32.0	12.0	9.0	7.12	\$1,070.00	---
ARG-2044-D	2.0	44.0	19.0	12.5	7.88	\$1,070.00	---
ARG-2044-DC	2.05	44.0	19.0	12.5	7.88	---	\$695.00

M5 stylus with solid diamond or diamond coated sphere, 1.5 mm diameter carbide stem, and 11.0 mm diameter stainless steel base.

We can supply a solid diamond or diamond coated sphere on just about any Q-Mark stylus equipped with a 1.0, 2.0, 3.0, or 5.0 mm diameter sphere. Please contact us at sales@cmms.com for a prompt quotation.

WARNING: The products on this page can expose you to chemicals including cobalt, nickel, and phenylhydrazine, which are known to the State of California to cause cancer, and bisphenol A (BPA), which is known to the State of California to cause birth defects or other reproductive harm. For more information go to www.p65warnings.ca.gov.

CT Scan Artifacts



Computed Tomography (CT) Scan Artifacts

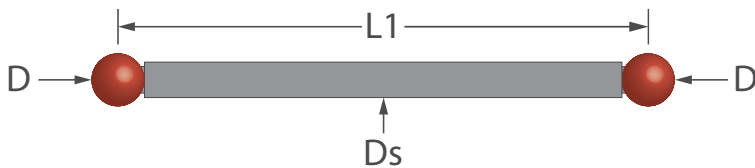

Part Number	D	L1	Ds	Wt	Price
CT-2022	2.0	20.0	1.5	0.05	\$100.00
CT-3033	3.0	30.0	2.0	0.18	\$110.00
CT-6066	6.0	60.0	3.5	1.71	\$135.00
CT-8088	8.0	80.0	6.0	5.37	\$160.00

Two ruby spheres mounted on a carbon fiber strut.

Mitutoyo Compatible Parts



Mitutoyo height gage holders for threaded styli

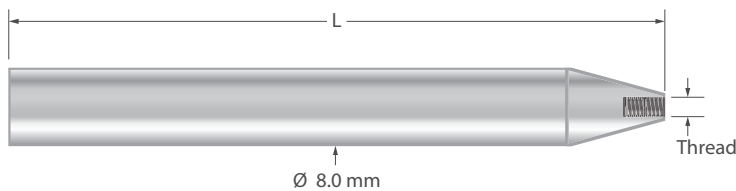

Part Number	Thread	L	Price
MH-M2	M2 x 0.4	54.0	\$90.00
MH-M3	M3 x 0.5	54.0	\$90.00

Stainless steel.

Mitutoyo height gage holders for unthreaded styli

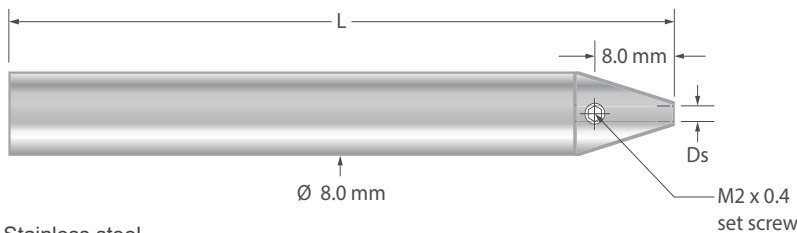

Part Number	Ds	L	Price
MH-10	1.0	67.0	\$60.00
MH-15	1.5	67.0	\$60.00
MH-20	2.0	62.0	\$60.00

Stainless steel.

To design your own stylus in 3D, please visit
www.cmms.com/design-your-own-stylus

Standard Stylus

1. Copy this page.
2. Fill in the blanks.

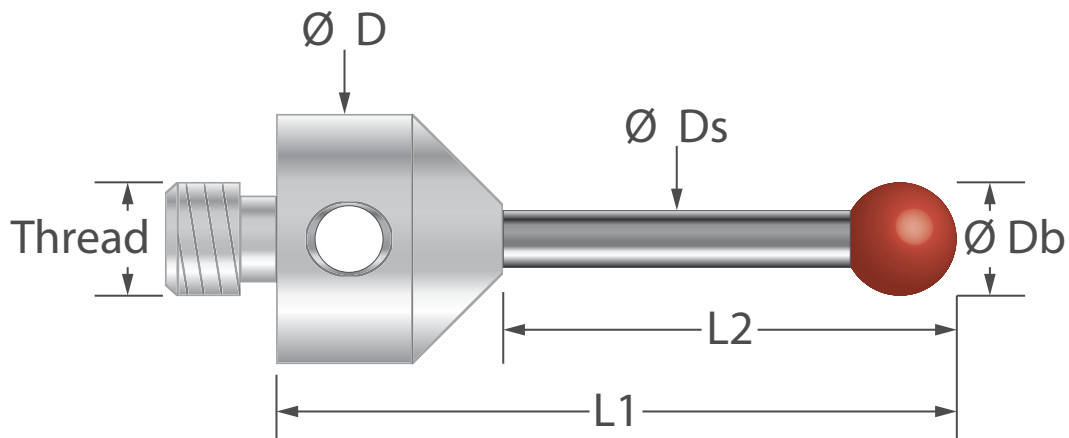

Thread	D	Ds	L1	L2	Db	Quantity

Your name _____ Phone _____

Company _____ Email _____

Ball material: ruby silicon nitride ceramic carbide other _____

Stem material: carbide ceramic carbon fiber steel other _____

Base material: stainless steel aluminum titanium other _____

Comments / special requirements: _____

To design your own stylus in 3D, please visit
www.cmms.com/design-your-own-stylus

Miniature Stylus

1. Copy this page.
2. Fill in the blanks.

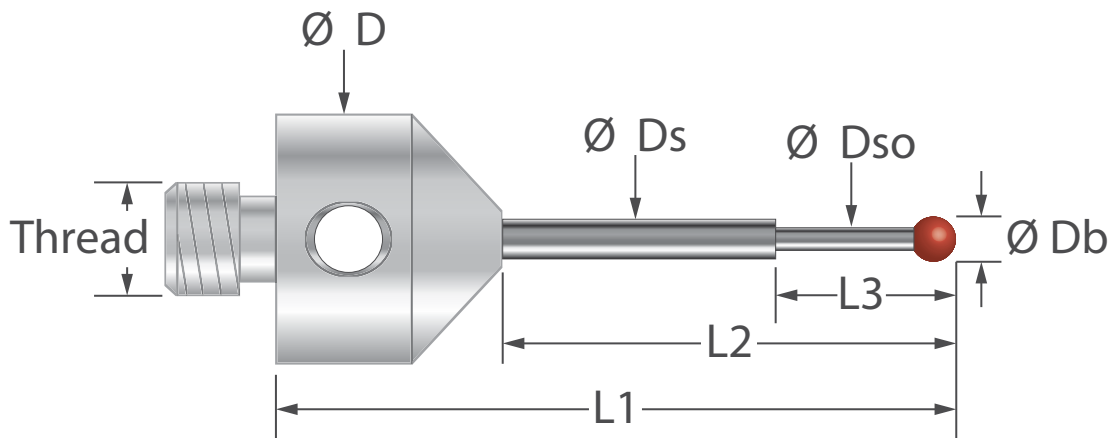

Thread	D	Ds	Dso	L1	L2	L3	Db	Quantity

Your name _____ Phone _____

Company _____ Email _____

Ball material: ruby silicon nitride ceramic carbide other _____

Stem material: carbide ceramic carbon fiber steel other _____

Base material: stainless steel aluminum titanium other _____

Comments / special requirements: _____

To design your own stylus in 3D, please visit
www.cmms.com/design-your-own-stylus

Disk Stylus

1. Copy this page.
2. Fill in the blanks.

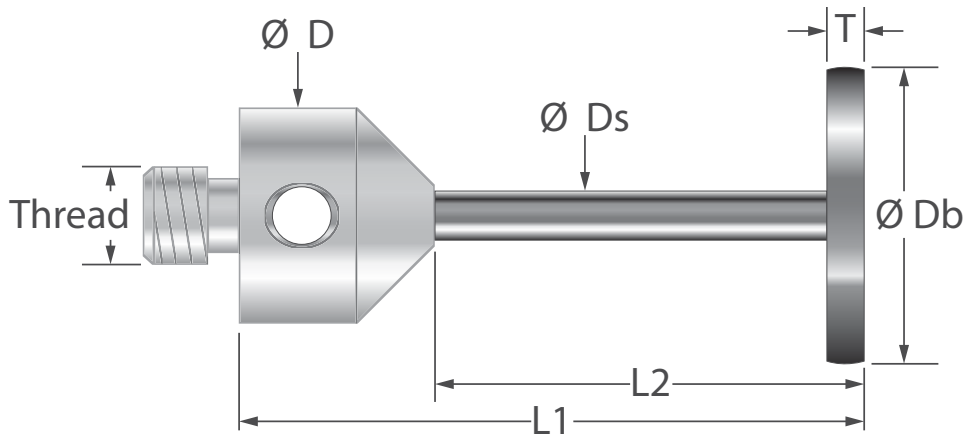

Thread	D	Ds	L1	L2	T	Db	Quantity

Your name _____ Phone _____

Company _____ Email _____

Disk material: hardened steel ceramic carbide other _____

Stem material: carbide ceramic carbon fiber steel other _____

Base material: stainless steel aluminum titanium other _____

Comments / special requirements: _____

SALES & SERVICE:

A Tech Authority, Inc.
13745 Stockton Ave.
Chino CA 91710
909-614-4522
sales@atechauthority.com

Proudly Made in the USA
Same-Day Shipping
Unconditionally Guaranteed

