

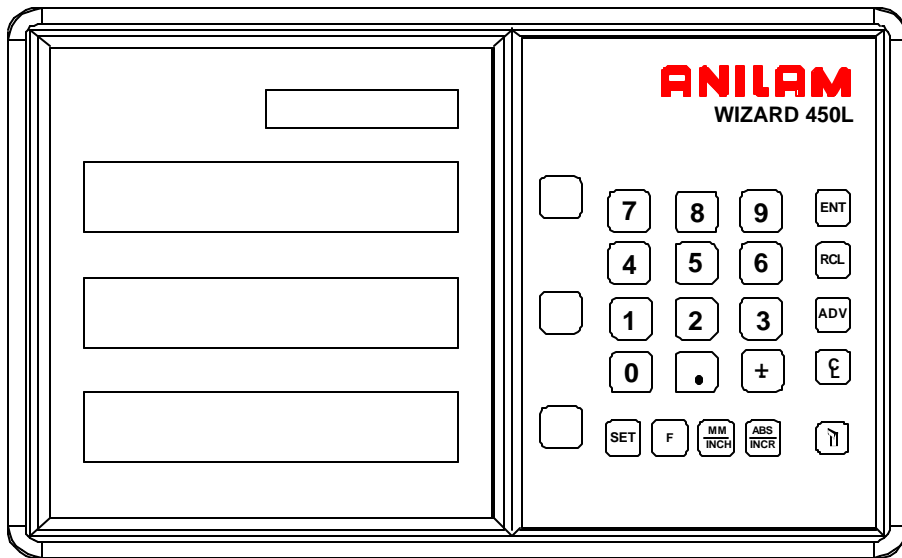

# Wizard 450/450L Digital Readout Operations Manual



**SALES & SERVICE:**  
**A Tech Authority, Inc.**  
13745 Stockton Ave.  
Chino CA 91710  
909-614-4522  
sales@atechauthority.com

## Warranty

ANILAM warrants its products to be free from defects in material and workmanship for three (3) years from date of installation. At our option, we will repair or replace any defective product upon prepaid return to our factory.

This warranty applies to all products when used in a normal industrial environment. Any unauthorized tampering, misuse, or neglect will make this warranty null and void.

Under no circumstances will ANILAM, any affiliate, or related company assume any liability for loss of use or for any direct or consequential damages.

The foregoing warranties are in lieu of all other warranties expressed or implied, including, but not limited to, the implied warranties of merchantability and fitness for a particular purpose.

**System Purchased From:** \_\_\_\_\_

**Console Part Number:** \_\_\_\_\_

**Console Serial Number:** \_\_\_\_\_

**Date of Installation:** \_\_\_\_\_

## Feature, Operation, and Technology

WIZARD Digital Readouts provide the absolute latest in ease of operation, capability, and technology. As a result, ANILAM may alter and enhance operation, features, and capabilities without notice.

© Copyright 2004 ACU-RITE Companies, Inc.

# Contents

Contents .....	v
Introducing the Wizard.....	1
The ANILAM Wizard 450/450L Keypad and Display Windows .....	2
The ANILAM Wizard 450/450L Back Panel.....	3
First-Time User Checklist .....	5
About This Manual.....	7
Function Code List.....	8
Beeper OFF/ON – F 21 .....	11
Keyboard Entry Error .....	12
Inch/Metric Conversion .....	13
Decimal Degree to Degree-Minutes-Seconds Conversion.....	14
Plus/Minus ( $\pm$ ) Key.....	15
Absolute/Incremental (ABS/INCR) Key .....	16
Presetting a Dimension .....	17
Recalling a Preset Dimension .....	18
Clearing a Preset Dimension.....	19
Resetting an Axis to Zero .....	20
Axis Reset Only – F 16.....	21
Absolute Zero Set – F 01.....	23
Absolute Zero Set at Reference Mark – F 90.....	24
EverTrack™ Mode – F 02.....	25
Last Position Save/Recall – F 10/F 11 .....	30
Adding/Subtracting Values .....	31
Dividing an Axis Value by 2 .....	32
Centering Key .....	33
Radius/Diameter per Axis – F 05.....	35
Setting a Correction Factor – F 03 .....	37
100-Point Axis Error Compensation – F 80/F 81.....	39
Measure the Axis .....	39

## Contents (Continued)

Selecting the Compensation Table, Entering an Axis Compensation .....	41
Key Functions for Compensation Table.....	44
Deleting a Compensation Value Table .....	45
Axis Error Compensation ON/OFF .....	46
Correction Factor OFF/ON – F 04 .....	47
Approaching Zero Indicator .....	48
Approaching Zero – F 06.....	49
Approaching Zero Range – F 07 .....	51
Approaching Zero Audio ON/OFF – F 08.....	53
Connecting the Edge Sensor Probe.....	54
Edge Sensor Probe – F 09.....	55
Feedrate ON/OFF – F 26 .....	57
Job Clock ON/OFF – F 34 .....	58
Parameter Settings – F 20.....	60
Setting Up Encoder Parameters.....	60
Metric Linear Encoders.....	62
Inch Linear Encoders (BT or JB Linear Encoders).....	67
Rotary Encoders .....	68
Display Dim OFF/ON – F 22/ F 23 .....	72
Axis Designation – F 24.....	73
Select Language – F 99 .....	74
Linear Encoder Error Detect OFF/ON – F 40/F 41.....	75
Diagnostics – F 45.....	76
Advanced (ADV) Functions Key.....	78
Help Function.....	78
Bolt-Hole Pattern Function (450 Only).....	80
Partial Bolt-Hole Pattern .....	82
Full Bolt-Hole Pattern (450 Only).....	86
Recalling Bolt-Hole Pattern Function (450 Only).....	90

## Contents (Continued)

Linear-Hole/Frame-Hole Pattern Function (450 Only).....	93
Recalling Linear-Hole/Frame-Hole Function (450 Only).....	98
Taper Calculator Function (450L Only).....	101
Datum Key (450 Only).....	103
Enter Datum.....	103
Enter Datum (Alternate Method).....	106
Recall Datum.....	108
Clear Datum – F 31.....	109
Tool Offset Key (450L Only).....	110
Enter Tool Offset.....	110
Recall Tool Offset.....	112
Modify Tool Offset – F 35.....	113
Clear Tool Offset – F 32.....	114
Axis Coupling (450L, 3-Axis Only) - F 18.....	115
Output Connections (With I/O Option Only).....	116
Input Connections (With I/O Option Only).....	117
Zero Output ON/OFF (With I/O Option Only) – F 33.....	118
Approaching Zero Output Axis (With I/O Option Only) – F 14.....	119
Zero Output Time Select (With I/O Option Only) – F 25.....	120
RS-232 Interface (With I/O Option Only).....	121
RS-232 Setup (With I/O Option Only) – F 27.....	122
RS-232 ON/OFF (With I/O Option Only) – F 28.....	125
Printing Axis Values (With I/O Option Only).....	126
Remote Operation (With I/O Option Only).....	127
Relay 1/Relay 2 Setup (With I/O Option Only) – F 38/F 39.....	128
Output Test (With I/O Option Only) – F 42.....	131
Constant Surface Speed (CSS) Setup (450L With CSS and I/O Options).....	132
DAC Output Voltage Setup (450L With CSS and I/O Options) – F 96.....	133
DAC Output Voltage Offset Adjustment (450L With CSS and I/O Options) – F 97.....	135

## Contents (Continued)

DAC Output Voltage Test (450L With CSS and I/O Options) – F 98 .....	136
Constant Surface Speed (CSS)/Direct RPM Operation (450L With CSS and I/O Options)	137
CSS/Direct RPM Input (450L With CSS and I/O Options) – F 48 .....	138
DAC Output Voltage ON/OFF (450L With CSS and I/O Options) – F 50 .....	142
Troubleshooting .....	143
Index-1 .....	Index-1

# Introducing the Wizard

Thank you for purchasing the ANILAM Wizard 450/450L Digital Readout (DRO).

Review these pages carefully to learn how to properly operate your new DRO.

The new DRO offers many features and capabilities never before used in conventional DRO systems. Two models are available: the standard **Wizard 450 DRO** and the special lathe version **Wizard 450L DRO**, which includes turning features such as tool-length offsets and taper checking.

This manual was written with you, the operator, in mind. Please take the time to study it. A little well-spent time now will ensure many years of trouble-free operation.

For additional information, please contact your local authorized ANILAM distributor, or call us directly:

ANILAM  
One Precision Way  
Jamestown, New York, U.S.A., 14701  
Phone: (716) 661-1700  
FAX: (716) 661-1884  
E-mail: [anilaminc@anilam.com](mailto:anilaminc@anilam.com)  
[www.anilam.com](http://www.anilam.com)

# Introducing the Wizard (Continued)

## The ANILAM Wizard 450/450L Keypad and Display Windows

**NOTE:** The Wizard 450 DRO is available in **one-axis**, **two-axes**, and **three-axes** models; the Wizard 450L DRO is available in **two-axes** and **three-axes** models. For simplicity, the procedures in this manual describe a three-axes model only.

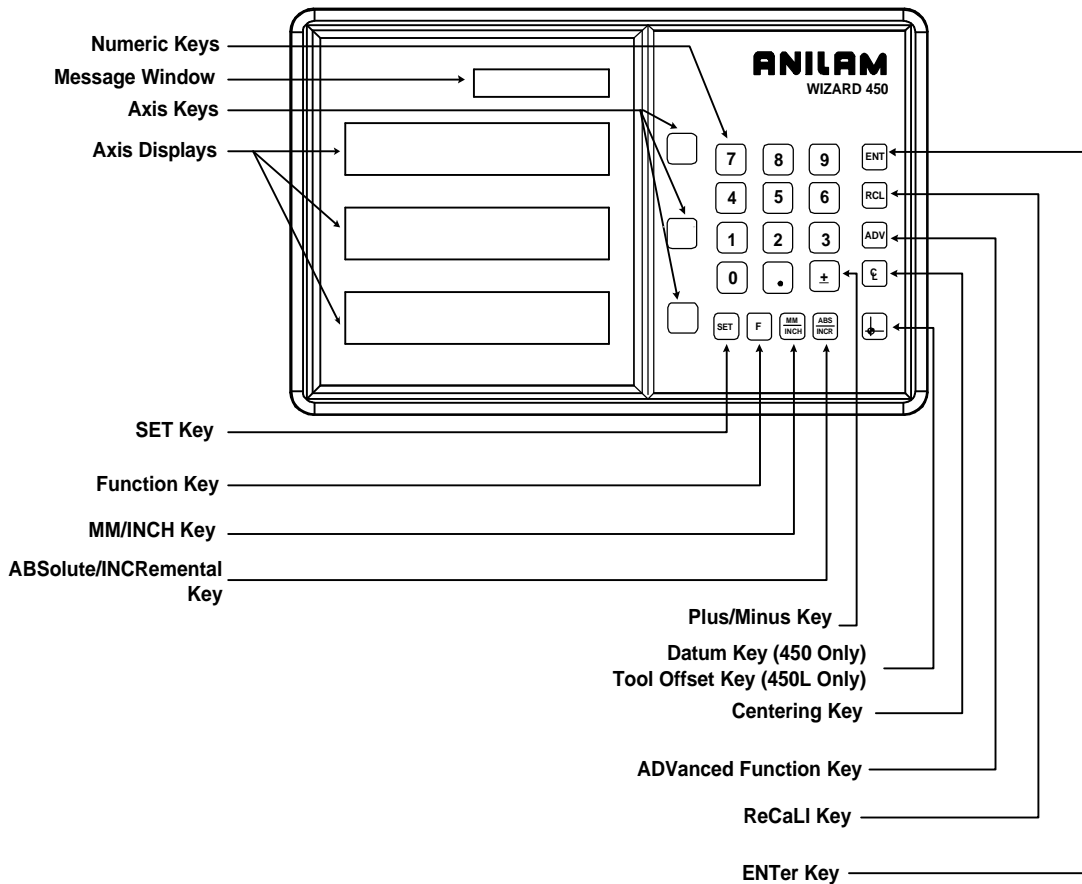



# Introducing the Wizard (Continued)

## The ANILAM Wizard 450/450L Back Panel

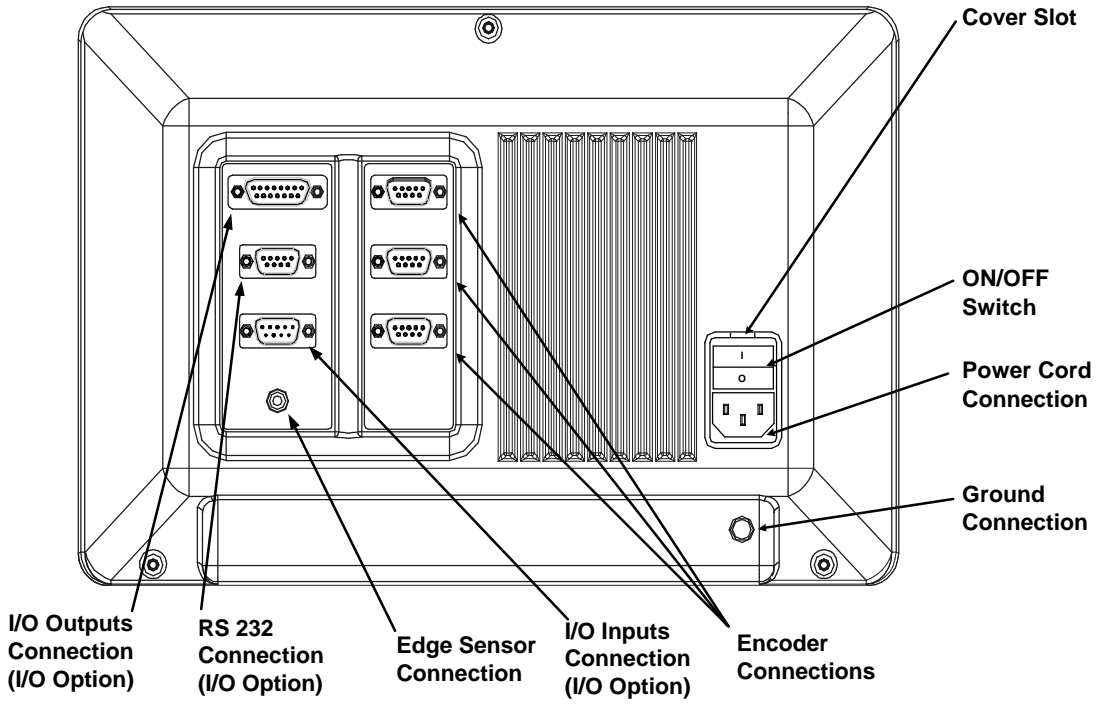

# Introducing the Wizard (Continued)

Your Wizard's display was designed to be easy to read:

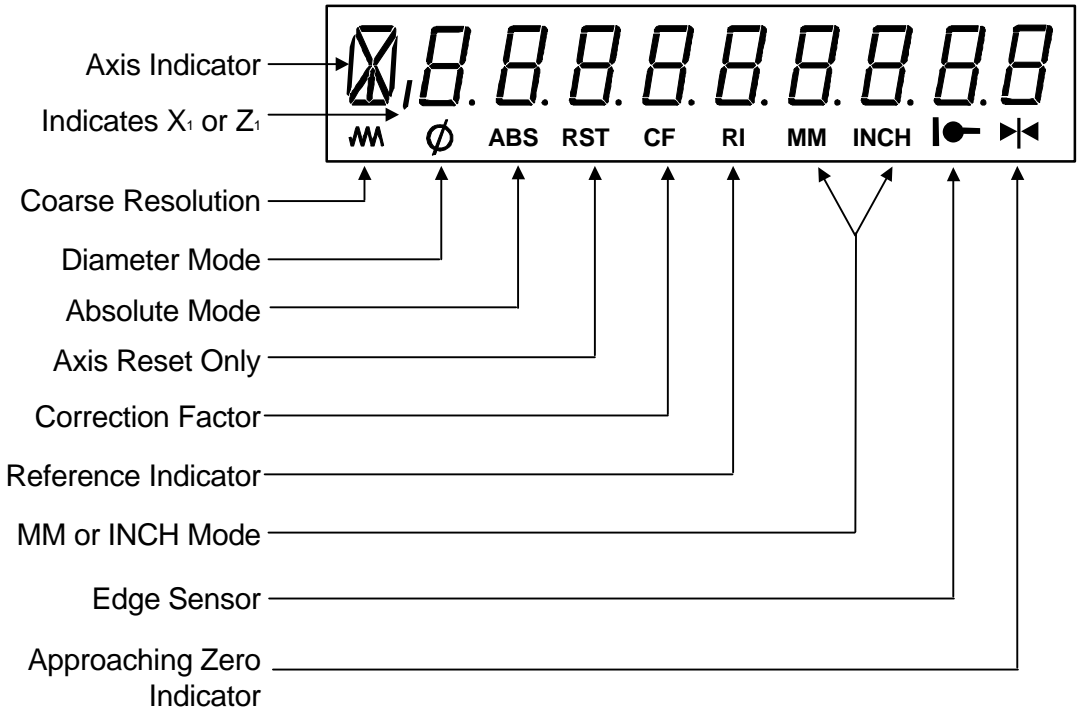

# First-Time User Checklist

Your new DRO has many preset values. Before you proceed, please review the following list to verify default settings. If you need to change any setting(s), refer to [Parameter Settings – F 20](#).

Description of Setting	Factory Setting		Your Setting
	450 DRO	450L DRO	
1. Mill/Lathe Operation	MILL	LATHE	
2. Linear Encoder Resolution	Axis 1	5 µm	
	Axis 2	5 µm	
	Axis 3	5 µm	
3. Direction of Count	Axis 1	+	
	Axis 2	+	
	Axis 3	+	
4. Position Tolerance Indicator	Axis 1	Set to Zero	
	Axis 2	Set to Zero	
	Axis 3	Set to Zero	
5. Audible Keyboard Tone	ON		
6. Display Resolution	Axis 1	.0002 inches (.005mm)	
	Axis 2	.0002 inches (.005mm)	
	Axis 3	.0002 inches (.005mm)	
7. Display Dimming	15 Minutes		
8. Radius/Diameter Mode	Axis 1	Radius	Diameter
	Axis 2	Radius	Diameter
	Axis 3	Radius	Diameter

## First-Time User Checklist (Continued)

For your safety, and to prevent damage to the machine, please verify the following:

9. DRO arm and DRO are securely mounted to the machine.	Yes/No
10. The DRO Input-voltage switch on the power-entry module (back panel) is set to the correct input voltage.	Yes/No
11. DRO is properly grounded. (Earth-ground to wall conduit or water pipe, for example, not grounded to the machine).	Yes/No
12. All cables are off the floor and out of the range of moving parts.	Yes/No

## **About This Manual**

This manual contains limited text and enlarged graphics for easy use. Actual keystrokes are represented by graphics.

The format is as follows:

### **Function Heading**

### **Function Description**

### **Example with Keystrokes**

### **Explanation of Procedures and Observations**

**NOTE:** Indicates you must use caution.

## Function Code List

You can access most DRO features using function codes. Function codes are codes entered by pressing the Function key (F) and then pressing the two-digit code for the feature. The following table lists the function codes available with your DRO. The page number indicates where the function is described in this manual.

Code	Description	Page
<a href="#">F 01</a>	<a href="#">Absolute Zero Set</a>	23
<a href="#">F 02</a>	<a href="#">EverTrack™ Mode</a>	25
<a href="#">F 03</a>	<a href="#">Setting a Correction Factor</a>	37
<a href="#">F 04</a>	<a href="#">Correction Factor OFF/ ON</a>	47
<a href="#">F 05</a>	<a href="#">Radius/Diameter per Axis</a>	35
<a href="#">F 06</a>	<a href="#">Approaching Zero</a>	49
<a href="#">F 07</a>	<a href="#">Approaching Zero Range</a>	51
<a href="#">F 08</a>	<a href="#">Approaching Zero Audio ON/OFF</a>	53
<a href="#">F 09</a>	<a href="#">Edge Sensor Probe</a>	55
<a href="#">F 10</a>	<a href="#">Last Position Save</a>	30
<a href="#">F 11</a>	<a href="#">Last Position Recall</a>	30
<a href="#">F 14</a>	<a href="#">Approaching Zero Output Axis Select</a> (With I/O Option Only)	119
<a href="#">F 16</a>	<a href="#">Axis Reset Only</a>	21
<a href="#">F 18</a>	<a href="#">Axis Coupling</a> (450L, 3-Axis Only)	115
<a href="#">F 20</a>	<a href="#">Parameter Settings</a>	60
<a href="#">F 21</a>	<a href="#">Beeper OFF/ ON</a>	11
<a href="#">F 22</a>	<a href="#">Display Dim OFF</a>	72
<a href="#">F 23</a>	<a href="#">Display Dim ON</a>	72
<a href="#">F 24</a>	<a href="#">Axis Designation</a>	73

## Function Code List (Continued)

Code	Description	Page
<a href="#">F 25</a>	<a href="#">Zero Output Time Select</a> (With I/O Option Only)	120
<a href="#">F 26</a>	<a href="#">Feedrate ON/OFF</a>	57
<a href="#">F 27</a>	<a href="#">RS-232 Setup</a> (With I/O Option Only)	122
<a href="#">F 28</a>	<a href="#">RS-232 ON/OFF</a> (With I/O Option Only)	125
<a href="#">F 31</a>	<a href="#">Clear Datum</a>	109
<a href="#">F 32</a>	<a href="#">Clear Tool Offset</a> (450L Only)	114
<a href="#">F 33</a>	<a href="#">Zero Output ON/OFF</a> (With I/O Option Only)	118
<a href="#">F 34</a>	<a href="#">Job Clock ON/OFF</a>	58
<a href="#">F 35</a>	<a href="#">Modify Tool Offset</a> (450L Only)	113
<a href="#">F 38</a>	<a href="#">Relay 1 Setup</a> (With I/O Option Only)	128
<a href="#">F 39</a>	<a href="#">Relay 2 Setup</a> (With I/O Option Only)	128
<a href="#">F 40</a>	<a href="#">Linear Encoder Error Detect OFF</a>	75
<a href="#">F 41</a>	<a href="#">Linear Encoder Error Detect ON</a>	75
<a href="#">F 42</a>	<a href="#">Output Test</a> (With I/O Option Only)	131
<a href="#">F 45</a>	<a href="#">Diagnostics</a>	76
<a href="#">F 48</a>	<a href="#">Constant Surface Speed (CSS) Diameter Output</a> (450L With CSS and I/O Options)	138
<a href="#">F 50</a>	<a href="#">DAC Output Voltage ON/OFF</a> (450L With CSS and I/O Options)	142
<a href="#">F 80</a>	<a href="#">100-Point Axis Error Compensation</a>	39
<a href="#">F 81</a>	<a href="#">100- Point Axis Error Compensation - Exit</a>	46
<a href="#">F 90</a>	<a href="#">Absolute Zero Set at Reference Mark</a>	24
<a href="#">F 96</a>	<a href="#">DAC Output Voltage Setup</a> (450L With CSS and I/O Options)	133
<a href="#">F 97</a>	<a href="#">Adjust DAC Output Voltage Offset</a> (450L With CSS and I/O Options)	135

## Function Code List (Continued)

Code	Description	Page
<a href="#">F 98</a>	<a href="#">Test DAC Output Voltage</a> (450L With CSS and I/O Options)	136
<a href="#">F 99</a>	<a href="#">Select Language</a>	74





## Beeper OFF/ON – F 21

The beeper is a standard feature on all ANILAM DROs. Use the beeper to acknowledge a keystroke. For correct keystrokes, a short tone sounds. For incorrect keystrokes, a long tone sounds.

**F 21** allows you to enable/disable the beeper in the DRO (Default: ON).

To turn the beeper OFF:

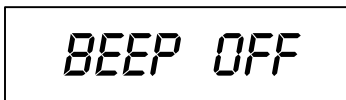

1. Press   

The DRO displays the following in the message window:



*BEEP OFF*

To turn the beeper ON:

1. Press   

The DRO displays the following in the message window:

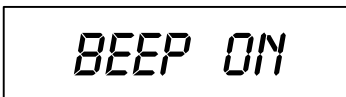

*BEEP ON*

## Keyboard Entry Error



If you enter an incorrect value, press the axis key again to clear the axis display. If you enter too many numbers on an axis, the DRO display reverts to zero on that axis. When this happens, enter the correct number again.

# Inch/Metric Conversion

This feature allows you to convert inch values to metric values and vice-versa on all axes.

**Example:** Change 1.000 inch to its metric (mm) equivalent.

1. Press the desired axis key to select the axis.

2. Press   

The DRO displays the following:

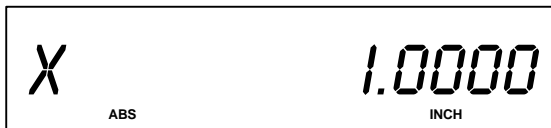

3. Press 

The DRO displays the following:

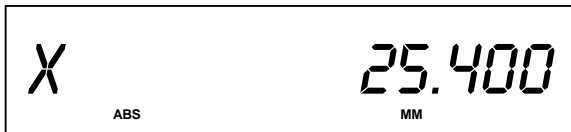

**NOTE:** The DRO displays the **INCH** or **MM** symbol under each axis display.

# Decimal Degree to Degree-Minutes-Seconds Conversion

You can use every axis to display angular position when you connect a rotary encoder to the DRO. The display range is  $\pm 360$  degrees.

**Note:** The axis must be set to rotary using [Parameter Settings – F 20](#).

To convert all angular axis displays from decimal degree display to degree-minutes-seconds display:

1. Press  

## Plus/Minus ( $\pm$ ) Key

The  $\pm$  key allows you to:

- ❑ Change the sign of a preset value.
- ❑ Change the direction of travel on a linear encoder while in parameter setting.
- ❑ Add and subtract values.
- ❑ Scroll through options lists while making selections.
- ❑ Scroll through the Advanced Functions (**ADV**) list.

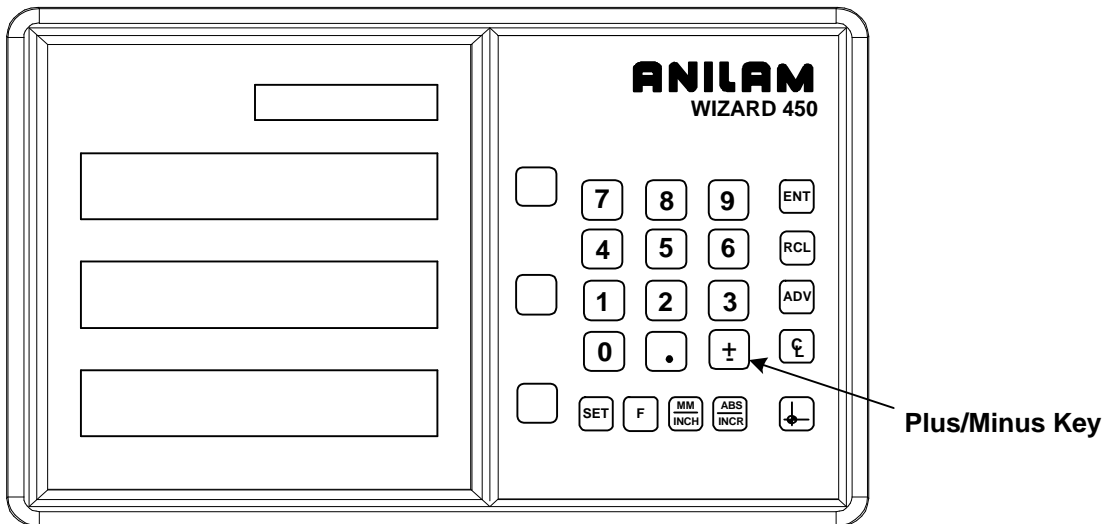

## Absolute/Incremental (ABS/INCR) Key

When the Absolute Mode indicator is OFF, the DRO measures in increments and internally tracks the corresponding absolute (**ABS**) dimensions. This is a safeguard and serves to measure the total distance being moved along a given axis.

Press **ABS/INCR** to switch the display to Absolute Mode. The Absolute dimension from the starting point is indicated on the axis display.

**Example:** If a series of six 2.00 inch (50.8 mm) incremental moves are made, change to **ABS** Mode to display the total distance moved, which is 12.000 inches (304.80 mm).

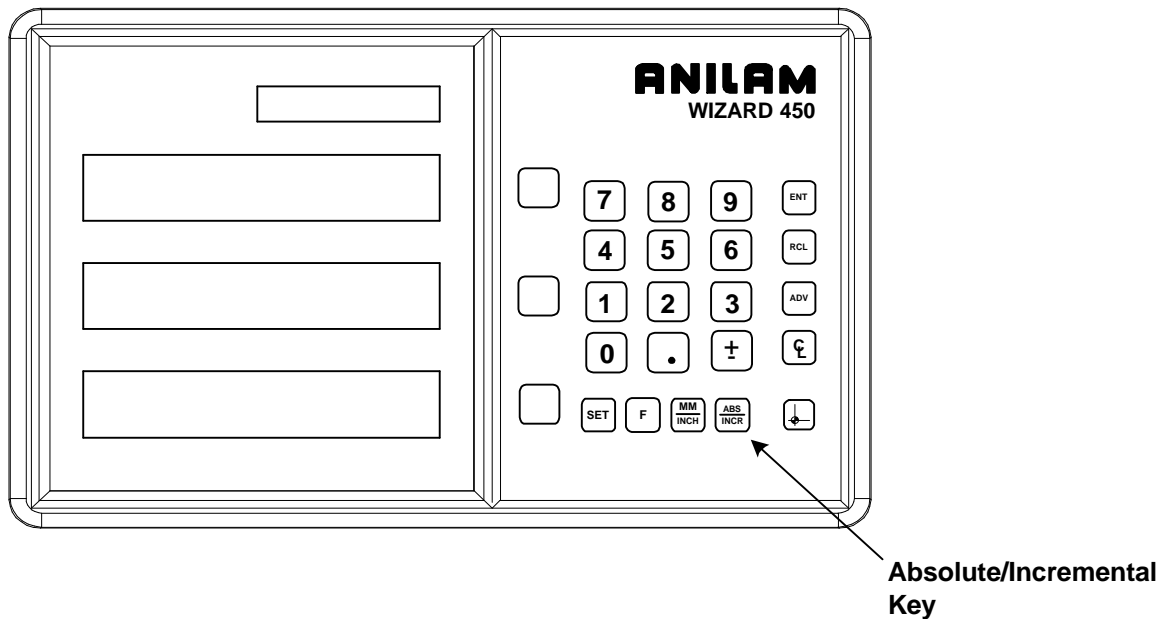

## Presetting a Dimension

Presetting allows you to enter a dimension into an axis display. After you have preset the dimension, you can move the machine until the axis indicates zero.

You can also use the preset feature as a one-line recall mode if the display is set in Incremental Mode.

**Example 1:** Preset the dimension **1.2500** (31.75 mm) on the axis display.

1. Press the desired axis key.

2. Press     to enter the dimension.

3. Press  to preset the dimension.

**Example 2:** Preset the dimension **- 1.2500 inches** (- 31.75 mm) on one axis display and **.5000** (12.7 mm) on another axis display.

1. Press the desired axis key.

2. Press      to enter the dimension.

3. Press the desired axis key.

4. Press   to enter the dimension.

5. Press  to preset the dimension.

**NOTE:** As a safety feature, the preset axis does not display movement until you press **SET**. If you press **SET** after you move the machine, the DRO automatically updates to the new position.

## Recalling a Preset Dimension

This feature allows you to recall a preset dimension to the axis display.

Use this feature when making multiple moves of the same dimension.

**NOTE:** This feature works only in Incremental Mode.

To recall a preset dimension:

1. Press  to set the display to Incremental Mode.
2. Press the desired axis keys to select the axes.
3. Enter the incremental dimension.
4. Move the machine to zero.
5. Press the desired axis key twice to recall the dimension.

**NOTE:** You can recall a dimension after you reset absolute zero or when you have regained power after a power loss.

To clear a preset dimension while in Incremental Mode:

1. Press the desired axis keys to select the axes.
2. Press 



## Clearing a Preset Dimension

When you clear a dimension, you automatically zero the previously entered dimension in an axis.

To clear preset dimensions, one axis at a time:

1. Press the desired axis key to select the axis.

2. Press



To clear entered dimensions for all axes:

1. Press the desired axis keys to select the axes.

2. Press



## Resetting an Axis to Zero

When you reset an axis, the display for that axis reverts to zero.

Use the reset feature when establishing part zero (datum) or clearing the axis at each part location (making incremental moves).

To reset one axis (X, Y, or Z):

1. Press the desired axis key to select the axis.

2. Press 

To reset two or more axes at the same time:

1. Press the desired axis keys to select the axes.

2. Press 

**NOTE:** See also [Absolute Zero Reset – F 01](#).

## Axis Reset Only – F 16

**F 16** is useful for quick positioning. Press the axis key once to zero the display in either **ABS** or **INCR** Mode.

**Example 1:** Set one axis as Axis Reset Only (For example, X-axis):

1. Press    to select the feature.

The DRO displays the following in the message window:



AXIS RESET

2. Press the desired axis key to toggle axis reset only ON (or OFF).

The DRO turns ON the **RST** symbol in the axis display:



X F 16  
RST

3. Press  to set the feature.

4. Press the X-axis key to zero the axis display in either **ABS** or **INCR** Mode.

**NOTE:** Perform the same procedure to turn OFF Axis Reset Only.

## Axis Reset Only – F 16 (Continued)

**Example 2:** Set two or more axes as Axis Reset Only (For example, X-axis and Y-axis):

1. Press    to select the feature.

The DRO displays the following in the message window:



AXIS RESET

2. Press the desired axis key to toggle axis reset only ON (or OFF).

The DRO turns ON the **RST** symbol in the axis displays.

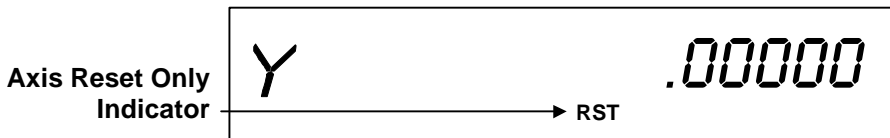
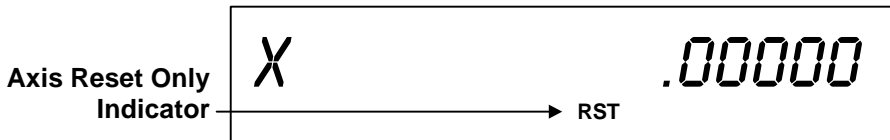

3. Press  to set the feature.

4. Press the X-axis key to zero the axis display in either **ABS** or **INCR** Mode.

**NOTE:** Perform the same procedure to turn OFF Axis Reset Only.

## Absolute Zero Set – F 01

**F 01** allows you to establish a part zero. The DRO clears all axis counters, both absolute and incremental, to zero.

**NOTE:** This feature does not clear a preset dimension entered in Incremental Mode. To clear a dimension entered in Incremental Mode, refer to [Recalling a Preset Dimension](#).

To reset all axes to zero:

1. Press   

The DRO temporarily displays the following in the message window:

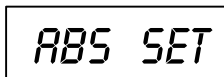

*ABS SET*

and then clears the axis displays.

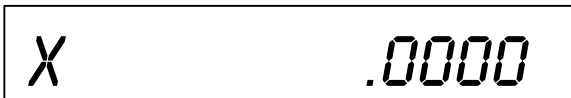

*X .0000*



*Y .0000*

## Absolute Zero Set at Reference Mark – F 90

**F 90** allows you to reset one or more axes to zero at the reference mark. You must use this feature when you use 100-point axis error compensation (**F 80/F 81**).



To reset all axes at the reference mark:

1. Press   

The DRO resets all axis displays and displays the following in the message window:

*MARKER*

To reset one axis at the reference mark:

1. Press   
2. Press the desired axis key.

3. Press 

The DRO resets the specified axis display and displays the following in the message window:

*MARKER*

## EverTrack™ Mode – F 02

**F 02** allows you to recall any position that has been previously stored in Absolute Mode, even in case of power outage. In EverTrack™ Mode, the DRO can access absolute references along the linear encoder. As a result, EverTrack™ Mode eliminates the need for a machine home position and a battery backup system.

**NOTE:** This feature works **ONLY** with **RBS-T** and **RBM-T** linear encoders, which contain absolute reference marks. If your application uses linear encoders without absolute reference marks, disable EverTrack™ Mode (*NO E-TRAC*) [Parameter Settings – F 20](#).

EverTrack™ Mode can be set either one axis at a time or all axes at a time. If you have a three-axis application but require less than three axes, we recommend that you set the part zero positions one axis at a time.

### Setting a Part Zero - One Axis

To set up a part zero position for one axis:

1. Press    to select the feature.

The DRO displays the following in the message window:



EVERTRACK

2. Press the desired axis key.

3. Press .

The axis display resets to zero and the Reference Indicator (**RI**) begins to blink.

**CAUTION:** During the following step, do not change the machine axis travel direction. This will cause an error.

4. Move the machine axis approximately 1 inch (25.4 mm) in one direction until the **RI** stops blinking and the display starts to count.

## EverTrack™ Mode – F 02 (Continued)

5. Move the machine axis to the part zero position.



6. Press

This will be the absolute part zero position.

**NOTE:** You can also preset a dimension as long as the DRO is in Absolute Mode. The zero position corresponding to the stored preset dimension will be stored and can be recalled using EverTrack™ Mode.

**CAUTION:** If you require a temporary datum while in EverTrack™ Mode, we recommend you exit the feature before you set the temporary datum.

To exit EverTrack™ Mode:



7. Press



8. Press

The **RI** turns off and the DRO stores the absolute part zero position. Now you can perform an absolute reset (Axis key + **SET** key) on an axis or an absolute reset (**F 01**).

### Setting a Part Zero – All Axes

To set up a part zero position for all axes:



1. Press

to select the feature.

The DRO displays the following in the message window:





## EverTrack™ Mode – F 02 (Continued)

2. Press 

The axis displays reset to zero and the **RI**s begin to blink for each axis.

**CAUTION:** During the following step, do not change the machine axis travel direction. This will cause an error.

3. Move each machine axis approximately 1 inch (25.4 mm) in one direction until the **RI**s stop blinking and the display starts to count.

4. Move each machine axis to the part zero position.

5. Press   

This will be the absolute part zero position.

**NOTE:** You can also preset dimensions as long as the DRO is in Absolute Mode. The zero position corresponding to the stored preset dimensions will be stored and can be recalled using EverTrack™ Mode.

To exit EverTrack™ Mode:

6. Press   

The DRO displays the following in the message window:



*EVERTRACK*

7. Press 

The **RI** turns off and the DRO stores the absolute part zero position.

8. Continue with normal operations.

# EverTrack™ Mode – F 02 (Continued)

## Recalling a Part Zero Position

To recall a part zero position activate the **RI** as follows:

### One Axis

1. Press    to select the feature.  
Press the desired axis key.

Press 

The axis display resets to zero and the **RI** begins to blink.

### All Axes

1. Press    to select the feature.

Press  to select all axes.

The axis displays reset to zero and the **RI**s begin to blink for each axis.

**CAUTION:** During the following step, do not change the machine axis travel direction. This will cause an error.

2. Move the machine axis approximately 1 inch (25.4 mm) in one direction until the display starts counting.

The value displayed on the axis display indicates the exact distance from the absolute part zero position.

3. Move the machine axis until the display indicates zero.

Zero indicates the exact absolute part zero position.

## EverTrack™ Mode – F 02 (Continued)

To exit EverTrack™ Mode:

4. Press   

5. Press 

## Last Position Save/Recall – F 10/F 11

**F 10** allows you to save the machine's last position before turning OFF the machine; **F 11** allows you to recall the saved position after turning ON the machine.

**NOTE:** If you have **EverTrack™ Mode**, you can always recall all datum points, even if you move the table during power-off.

**IMPORTANT: Lock all axes of machine movement first.**

To select the feature and save the last position:

1. Press   

The DRO displays the following in the message window:



SAVE POS

2. Turn OFF the DRO power.

To recall the saved position:

1. Turn ON the DRO power.

2. Press   

to recall the last machine position to the display.

The DRO displays the following in the message window:



RECALL POS

3. Unlock the machine and continue with the job.

**NOTE:** This feature stores display information only. It does not track table movement when power is turned OFF.

## Adding/Subtracting Values

This feature allows you to add or subtract values using the axis display values. You can add/subtract a value to/from a value displayed for a machine position or for values you enter in an axis display.

**Example 1:** The axis display indicates **3.425** inches (**87** mm). To add **1.259** inches (**32** mm) to this value:

1. Press the desired axis key to select the axis.

2. Press

The axis display now indicates **4.684** (**119** mm).

**Example 2:** To subtract **1.259** inches (**32** mm) from **3.425** inches (**87** mm) in the axis display:

1. Press the desired axis key to select the axis.

2. Press

3. Press the desired axis key to select the axis.

4. Press

The axis display now indicates **2.166** inches (**55** mm).

## Dividing an Axis Value by 2

This feature allows you to divide a value on an axis display by 2. You can also divide any values entered in an axis display by 2.







**Example 1:** The axis display indicates **7.126** inches (**181** mm). To divide this value by 2:

1. Press 
2. Press the desired axis key.

The axis display now indicates **3.563** inches (**90.5** mm).

**Example 2:** To divide **1.260** inches (**32** mm) by 2 in the axis display:

1. Press the desired axis key.

2. Press      

3. Press 

4. Press the desired axis key.

The axis display now indicates **.630** inches (**16** mm).

**NOTE:** You can use this feature to find the center point of a workpiece by zeroing the tool at one edge of the workpiece, then moving the tool to the opposite edge and dividing by 2.

# Centering Key

The Centering Key allows you to center the tool on the centerline of the workpiece, or on a specific position on the workpiece.

**Example:** To center the tool on the centerline of the workpiece:

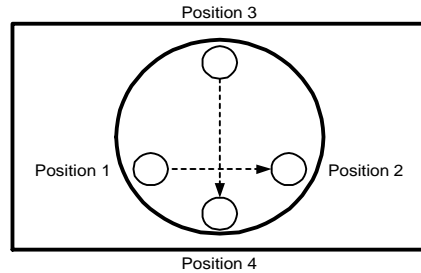
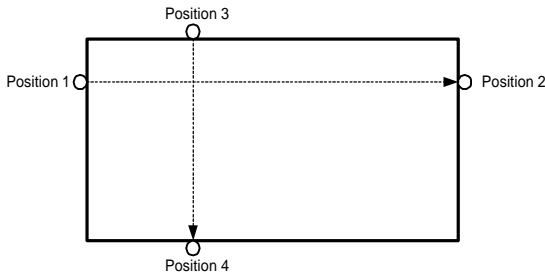

1. Press

to activate the feature.

The DRO displays the following in the message window:



2. Move the tool to position 1.



3. Press

The DRO displays the following in the message window:



4. Move the tool to position 2.



5. Press

## Centering Key (Continued)

The DRO displays the following in the message window:



EDGE Y1

6. Move the tool to position 3.

7. Press 

The DRO displays the following in the message window:



EDGE Y2

8. Move the tool to position 4.

9. Press 

10. Move both axes until the displays indicate **0** (zero).

This is the centerline of the workpiece.

To exit the centering feature:

11. Press 

**NOTE:** To center the tool on the centerline of the X-axis only, skip the steps for the Y-axis entries. To center the tool on the centerline of the Y-axis only, press the Y-axis key after you press the centering key.



## Radius/Diameter per Axis – F 05

**F 05** allows you to display a specified axis in Radius or diameter mode. The DRO doubles axis movement and resolution In Diameter Mode. (Default for 450L: ON)

**Example 1:** Set one axis display in diameter mode.

1. Press    to select the feature.

The DRO displays the following in the message window:

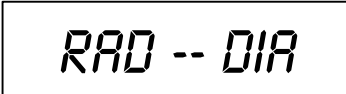

*RAD -- DIA*

2. Press the desired axis key to select the axis.

The DRO displays the radius-diameter mode indicator in the selected axis display.

Radius-Diameter  
Mode Indicator → 

3. Press  to activate the feature.

**Example 2:** Set two or more axis displays in diameter mode.

1. Press    to select the feature.

The DRO displays the following in the message window:

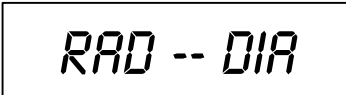

*RAD -- DIA*

## Radius/Diameter per Axis – F 05 (Continued)

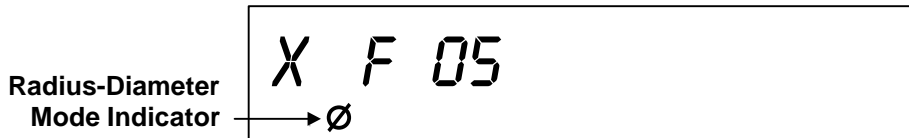

2. Press the desired axis keys to select the axes.

The DRO displays the radius-diameter mode indicator in the selected axis displays.



3. Press  to activate the feature.

To turn Diameter Mode OFF:

1. Press   
2. Press the axis key(s).

The DRO turns OFF the radius-diameter mode indicator symbol(s), indicating the radius-diameter mode is turned off.

## Setting a Correction Factor – F 03

**F 03** allows you to compensate for nominal linear inaccuracies due to your machine or for adding material shrinkage/expansion, as in mold work.

The maximum allowable settings are  $\pm 40\%$ .

**Example:** Consider a 1.325-inch (33.655 mm) travel on the display that is only 1.320-inch (33.528 mm) actual distance moved on the axis.

To set a correction factor for the axis:

1. Press    to activate the **CF** feature.

The DRO displays the following in the message window:



SET CORFCT

2. Press the desired axis key to select the axis.

The DRO displays the following in the axis display:



X 00000

3. Move the machine axis to 1.325 on the display.
4. Press the desired axis key again.

5. Press      to enter the actual distance.

6. Press 

## Setting a Correction Factor – F 03 (Continued)

The Correction Factor (CF) indicator in the displayed axis turns ON indicating the Correction Factor is active.

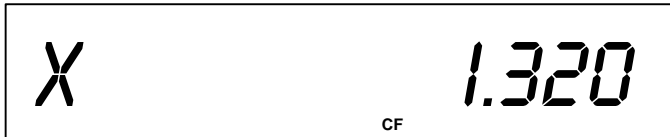

## 100-Point Axis Error Compensation – F 80/F 81

**F 80/F 81** allow you to correct non-linear errors. The DRO allows setting a compensation table with a maximum of 100 different points per axis. This feature allows you to compensate for machine tool inaccuracies.

To determine the compensation values it is necessary to measure the axis with a Laser Interferometer or other measuring device.

Axis Error Compensation is only possible if the Reference mark evaluation is activated (EverTrack™).

1. Press **F** **0** **2**
2. Press the desired axis key and **SET**
3. Move the linear encoder for the axis across the reference mark until **RI** stops blinking and the display starts to count.

### Measure the Axis

To measure the axis, switch the DRO to mode “REFERENCE DISPLAY”.

1. Press **F** **8** **0**

The DRO displays the following in the message window:

*SEL AXIS*

# 100-Point Axis Error Compensation F 80/F 81 (Continued)

## Measure the Axis (Continued)

2. Press the desired axis key.

3. Press  key.

The DRO displays the following in the message window:

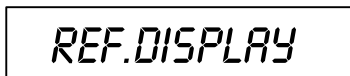



*REF.DISPLAY*

The decimal point in the left display field indicates that the display values are referenced to the Reference mark. If the decimal point blinks, the Reference mark has not been traversed.

Now, if required, you can set a zero to datum point for the “Reference Display”.

For example, press the desired axis and

Press   to set zero point for “Reference Display”.

Measure the axis and note the compensation values for later programming.

As the compensation is always related to the “Reference Display”, you are not allowed to change the zero or datum point for the “Reference Display” after measuring.

Press  to leave the “Reference Display” mode.

# 100-Point Axis Error Compensation F 80/F 81 (Continued)

## Selecting the Compensation Table, Entering an Axis Compensation

1. Press   

The DRO displays the following in the message window:

*SEL AXIS*

2. Press the desired axis key.

The DRO displays the following in the message window:

*AXIS X*

3. Press 

The DRO displays the following in the message window:



*DATUM X*

Datum point for the axis to be corrected. Here you enter the start point at which the axis with error is to be corrected. This point indicates the distance to the zero position for the “Reference Display”.

# 100-Point Axis Error Compensation F 80/F 81 (Continued)

## Selecting the Compensation Table, Entering an Axis Compensation (Continued)

Enter, for example: 0 mm

Press  

The DRO displays the following in the message window:

*SPACING X*

Enter the spacing between the compensation points.

Factory setting: 10 mm

Enter, for example: 5 mm

Press  

The DRO displays the following in the message window:

*X NO. 00*

*. 0.000*

X-axis display shows compensation point no. 0

*0.000*

Y-axis display shows compensation value no. 0

**NOTE:** Compensation point 0 always has the compensation value 0 and cannot be changed.



# 100-Point Axis Error Compensation F 80/F 81 (Continued)

## Selecting the Compensation Table, Entering an Axis Compensation (Continued)

**SET**

Press

The DRO displays the following in the message window:

*X NO. 01*

*. 5.000*

X-axis display shows compensation point no. 1

*-----*

Y-axis display shows compensation value no. 0

Enter the associated compensation value for point no. 1 and confirm with SET.  
For example: 0.002 mm

**.**

**0**

**0**

**2**

Press

**SET**

Press

The DRO displays the following in the message window:

*X NO. 02*

Repeat this procedure for all further compensation points (no. 2 – no. 99).

# 100-Point Axis Error Compensation F 80/F 81 (Continued)

## Selecting the Compensation Table, Entering an Axis Compensation (Continued)

**NOTE:** For 1-axis version, the compensation point displays only briefly in axis display, before compensation value is shown. If you press, the **CE** key, the compensation point is shown again.

### Key Functions for Compensation Table



**SET** key: Confirm entry and page forward in the compensation table



**MM/INCH** key: Page backward in the compensation table.



**ABS/INCR** key: Change to "REFERENCE DISPLAY" mode.



**ADV** key: Direct selection of compensation points.  
Press the ADV key and the two-digit number of the desired compensation point.



Exit the compensation table.

# 100-Point Axis Error Compensation F 80/F 81 (Continued)

## Deleting a Compensation Value Table

To delete a compensation value table:

1. Press   

The DRO displays the following in the message window:

*SEL AXIS*

2. Select the table for the specified axis with the axis key.



The DRO displays the following in the message window:

*AXIS X*

3. Press 

The DRO displays the following in the message window:

*DELETE X*

Delete the compensation value table with  key, or cancel with  key.

# 100-Point Axis Error Compensation F 80/F 81 (Continued)

## Axis Error Compensation ON/OFF

1. Press **F** **8** **1**

The DRO displays the following in the message window:

*99 - PT.ACTIV*

A programmed error compensation can be switched ON or OFF for each axis with the axis key. If compensation is active, the red symbol “**CF**” in the corresponding display is on.

## Correction Factor OFF/ON – F 04

**F 04** allows you to turn the Correction Factor (**CF**) OFF or ON selectively and store the values in memory.

To turn the correction factor ON or OFF:

1. Press    to select the feature.

The DRO displays the following in the message window:



*CF ON--OFF*

2. Press the desired axis key to select the axis to enable or disable **CF**.
3. If necessary, turn the correction factor ON or OFF for any axis.

To clear the correction factor from memory:

1. Press   

The DRO displays the following in the message window:



*SET CORFCT*

2. Press the desired axis key to select the axis to clear.
3. Press the axis key twice to clear the **CF**.

4. Press 

## Approaching Zero Indicator

This feature indicates that the machine is within a set range and is approaching zero.

The approaching zero indication range must be set using [Approaching Zero Range – F 07](#).

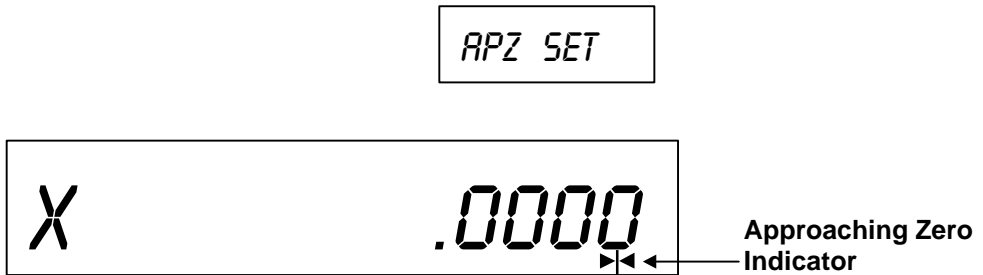

## Approaching Zero – F 06

**F 06** indicates when an axis is within a set range and approaching zero, or at zero.

1. Press **F** **0** **6** to select the feature.

The DRO displays the following in the message window and axis displays:

*RPZ SET*

*X F 06*

*Y*

2. Press the desired axis keys to select the axes.

The DRO displays the approaching zero indicator(s) on the selected axis display(s).

*RPZ SET*

*X F 06*



*Y*



3. Press **SET** to activate the feature.

## Approaching Zero – F 06 (Continued)

To turn the approaching zero indicator OFF:

1. Press **F** **0** **6** to select the feature.
2. Press the desired axis key to deselect the axis.
3. Press **SET**

**NOTE:** The following example shows an axis with an approaching zero position tolerance set to **.5**. The symbols in the lower right corner of the display indicate the axis is approaching zero, at zero, or past zero. The arrows indicate the direction of travel toward zero only if you preset a range using [Approaching Zero Range – F 07](#).



Approaching zero.



At zero.

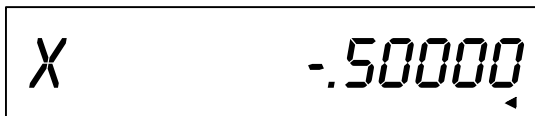

Past zero.



## Approaching Zero Range – F 07

**F 07** allows you to set the range for approaching zero indication in one or more axes.

**Example:** To set the range for the X-axis to .5:

1. Press    to select the feature.

The DRO displays the following in the message window:



*APZ RANGE*

The axis displays indicate the current approaching zero range.

2. Press axis 1 key to select the axis.

The DRO displays the following in the axis display:



X 0

The X is blinking.

3. Press  

The DRO displays the following in the axis display:



X .5

## Approaching Zero Range – F 07 (Continued)

To set the range for another axis:

4. Repeat steps 2 and 3 for each axis.

5. Press  to activate the feature.

## Approaching Zero Audio ON/OFF – F 08

**F 08** enables/disables an audible beep to notify you when the selected axis is within the approaching zero range. (Default: OFF)

To turn on audio notification for the selected axis:

1. Press   

The DRO displays the following in the message window:



*APZ AUDIO*

To turn off audio notification for the selected axis:

1. Press   

The DRO displays the following in the message window:

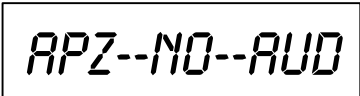

*APZ--NO--AUD*

## Connecting the Edge Sensor Probe

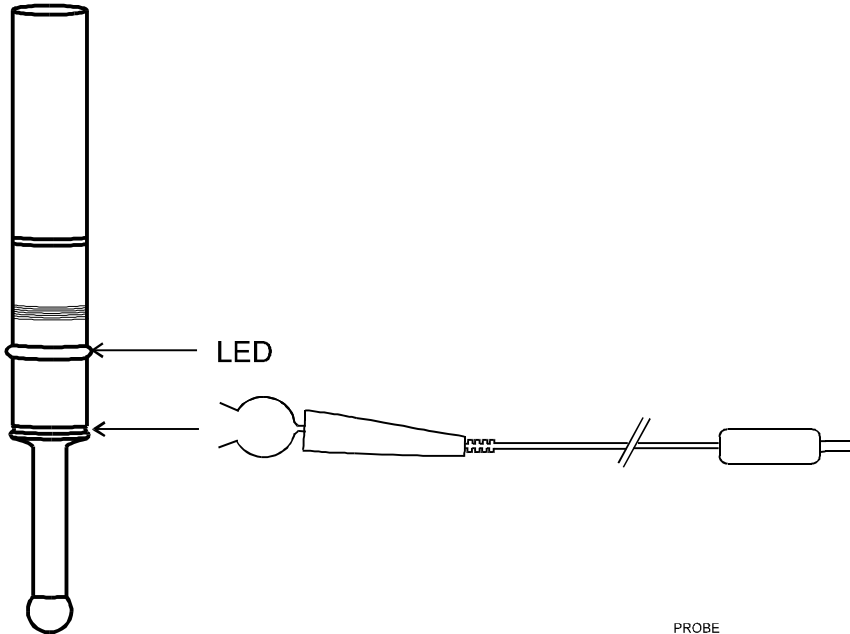

**CAUTION:** To avoid electrical shock, unplug the DRO from the power source.

1. Connect the ground wire on the back of the DRO to a proper earth ground.
2. Place the round spring clip in the appropriate groove on the probe.

**NOTE:** Ensure that the round spring clip on the probe cable is connected to the probe below the LED.

3. Plug the other end of the probe cable into the circular jack on the back of the DRO.

The red LED on the probe should glow dimly, indicating a proper connection. When you touch the probe tip to the workpiece, the red LED should glow brightly.

## Edge Sensor Probe – F 09

**F 09** allows you to position the spindle on the edge of the workpiece.

To activate the edge sensor probe:

1. Press **F** **0** **9**

The DRO displays the following in the message window:

*PROBE EDGE*

**NOTE:** When you move the X-axis from left to right, enter a positive diameter; when you move the X-axis from right to left enter a negative diameter (See Figure 5).

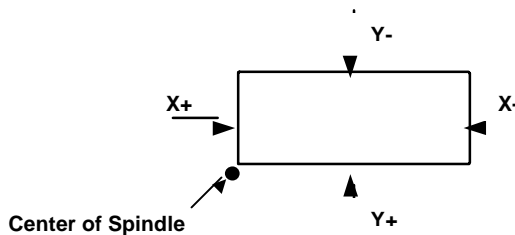

**Figure 5: Choosing Direction of Movement**

**Example:** To enter a probe diameter of .2 Inches (5.08 mm) for the X-axis (moving from left to right):

2. Press the axis key to select the axis.

The DRO displays the following in the message window:

*PROBE DIA*

## Edge Sensor Probe – F 09 (Continued)

To enter the probe diameter:

3. Press 

to toggle to plus or minus,  
for the desired direction of  
movement (See Figure 5).

4. Press   

The DRO displays the following in the message window and axis display:

*PROBE X +*

 *.0000*  
Edge Sensor Indicator



5. Move the edge sensor until it touches the edge of the workpiece and the edge sensor indicator turns off.
6. Move the spindle until the axis display indicates zero.

This is the edge of the workpiece.

## Feedrate ON/OFF – F 26

**F 26** allows you to display the maximum feedrate for all axes in the message window (if feedrate is greater than 0.4 inches per minute or greater than 10 mm per minute). The DRO displays the feedrate in inches per minute if set to **INCH** mode and mm per minute if set to **MM** mode. If you move two or more axes at the same time, the DRO displays the feedrate for the fastest moving axis. (Default: OFF)

To turn on the feedrate:



1. Press   

The DRO displays the following in the message window:



*FEED ON*

To turn off the feedrate:

1. Press   

The DRO displays the following in the message window:

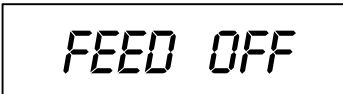

*FEED OFF*

## Job Clock ON/OFF – F 34

**F 34** allows you to toggle the DROs integrated job clock ON or OFF. When activated, the job clock displays the time in hours, minutes, and seconds in the message window. (Default: OFF)

To turn the job clock ON:

1. Press   

The DRO temporarily displays the following in the message window:



CLOCK ON

The DRO resets the axis display windows to zero and displays the job clock in the message window.

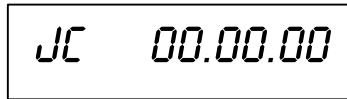

JC 00.00.00

To start or stop the job clock:

2. Press 

To reset the job clock to 0 (zero):

3. Press 

To redisplay the message window and run the job clock in the background or to redisplay the job clock:

4. Press 



## Job Clock ON/OFF – F 34 (Continued)

To turn the job clock OFF:

1. Press   

The DRO displays the following in the axis display window:



*CLOCK OFF*

The DRO clears the job clock display in the message window and resets the axis display windows to 0 (zero).

## Parameter Settings – F 20

**F 20** allows you to set up encoder parameters and axis display resolutions. To avoid confusion, it is important to know that here we refer to two different types of resolution, namely:

- ❑ **Encoder Resolution** the resolution of the measurement, an encoder parameter.
- ❑ **Display Resolution** the resolution of displayed values.

You can vary the resolution of the dimensions displayed in the linear axis displays for both **INCH** and **MM** mode. In case of a rotary axis, you can set up the display resolution for degrees in both decimal and minutes/seconds format. You can set the display resolution individually for each axis.

**F 20** allows you to enter specific properties for the encoders that are used for feedback. These can be set up individually for each axis. Your DRO will support three different types of encoders:

- ❑ **Metric Linear Encoders** (encoders with grating pitch measured in microns,  $\mu\text{m}$ )
- ❑ **Inch-Based Linear Encoders** (encoders with grating pitch measured in inches)
- ❑ **Rotary Encoders**

All modern linear encoders are of the Metric type.

### Setting Up Encoder Parameters

To enter encoder and axis display parameters:

1. Press    to select the feature.

The DRO displays the following in the message window:



2. Press the desired axis key(s) to select the axis (axes).

## Parameter Settings – F 20 (Continued)

**NOTE:** You can select one or more axes to set up simultaneously as long as they use the same encoders and the same display format is desired. You must repeat the **F 20** feature and select the appropriate axis (axes) for each different type of encoder setup.

The DRO displays the following in the message window:

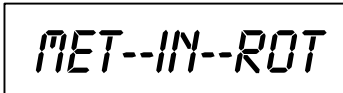

MET--IN--ROT

and the DRO displays one of the following in the selected axis display:





METRIC



INCH



ROT

3. Press  

to scroll through the encoder type options and set the desired encoder type.

## Parameter Settings – F 20 (Continued)

**NOTE:** Most linear encoders, and all modern ANILAM encoders are metric, i.e., they have a grating pitch measured in microns ( $\mu\text{m}$ ). Some older linear encoders (for example, **BT** and **JB** type encoders) have a grating pitch measured in inches. Select **rot** if the encoder is a rotary encoder.

Go to the section for the selected type of encoder:

- [Metric Linear Encoders](#)
- [Inch Linear Encoders](#)
- [Rotary Encoders](#)

### Metric Linear Encoders

If you have performed steps 1 through 3 in the [Setting Up Encoder Parameters](#) section and selected Metric Linear Encoder, the DRO prompts for the encoder resolution and direction of positive travel in the message window, and displays the default encoder resolution (**5 $\mu\text{m}$** ) in the axis display:

*RES -- DIR + --*

**X**  
ABS      5.000000  
MM

The axis designation (in this example, **X**) is blinking, indicating that you can enter a value. The default value for the encoder resolution is **5 $\mu\text{m}$** . This value must be exact for the specific encoder you are using for feedback.

## Parameter Settings – F 20 (Continued)

The following table lists the encoder resolution (in microns) for common ANILAM encoders:

Linear Encoder Type	Encoder Resolution
RBS-05T, RBM-05T	.5
RBS-1, RBS-1T, RBM-1T, B-1, E-1	1
RBS-2, A-2, C-2, E-2, F-2,	2
RBS-5, RBS-5T, RBM-5T, PGS-E, PGS-P, B-5, C-5, E-5, KM-5, 5 micron resolution Rack and Pinion	5
RBS-10, A-10, C-10, D-10, KM-10 10 micron resolution Rack and Pinion	10

**NOTE:** If the table does not list the linear encoder type/resolution for the linear encoder(s) you are using, and you do not know the exact encoder resolution, call ANILAM for advice. If you are using **BT** or **JB** linear encoders (inch linear encoders) refer to the [Inch Linear Encoders](#) section.

If you need to change the encoder resolution setting:

1. Enter the correct setting (in microns) for the encoder you are using.

If you need to change the direction of positive travel:

2. Press  to change the direction of positive travel.

3. Press  to set the encoder resolution and direction of travel.

## Parameter Settings – F 20 (Continued)

The DRO displays the following in the message window and axis display(s):

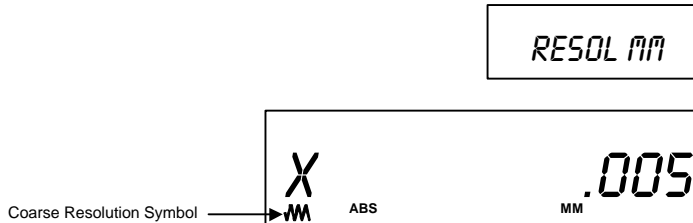

This is the display resolution setting for the axis display(s) when the **MM/INCH** key has been toggled to **MM** mode only. The axis designation is blinking, indicating that you can enter a value. The DRO will default the same display resolution as the encoder resolution (in this example, **.005 MM**). ANILAM recommends that you use the same display resolution as the encoder resolution.

4. Press



to scroll through the display resolution options in MM mode.

The display resolution options for MM mode are:

.0002, .0005, .001, .002, 005, .01, .02, .05, .1, .2, .5 **MM**

**NOTE:** If the selected display resolution is coarser than the encoder resolution, the DRO turns on the Coarse Resolution Symbol in the axis display(s).

5. Press



to select the desired display resolution in MM mode.

## Parameter Settings – F 20 (Continued)

The DRO displays the following in the message window and axis display:

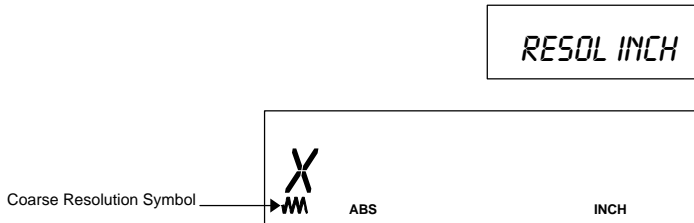

This is the display resolution setting for the axis display(s) when the **MM/INCH** key has been toggled to **INCH** mode only. The axis designation is blinking, indicating that you can enter a value. The DRO will default the same display resolution as the encoder resolution (in this example, **.0002 in.**). ANILAM recommends that you use the display resolution that best matches the encoder resolution.

6. Press  to scroll through the display resolution options in INCH mode.

The display resolution options for Inch Mode are:

.00001, .00002, .00005, .0001, .0002, .0005, .001, .002, .005, .01, .02 **Inches**

**NOTE:** If the selected display resolution is coarser than the encoder resolution, the DRO turns on the Coarse Resolution Symbol in the axis display(s).

7. Press  to select the desired display resolution in INCH mode.

## Parameter Settings – F 20 (Continued)

The DRO displays the following in the message window:

**E-TRAC SET**

to set up EverTrack™ mode.

and the displays one of the following in the selected axis display:

<b>Setting</b>		<b>Linear Encoder</b>
i20	r05	RBS-05T and RBM-05T only
i20	r1	RBS-1T and RBM-1T only
i20	r5	RBS-5T and RBM-5T (default)
no E-trac		All other linear encoders

8. Press  to scroll through the options.

9. Press  to set the option and exit.

To reset all parameter settings to the original factory configuration:

10. Press  for approximately **5** seconds (Press **F** again to cancel the reset).

11. Press  to reset all parameters.



## Parameter Settings – F 20 (Continued)

### Inch Linear Encoders (BT or JB Linear Encoders)

If you have performed steps 1 through 3 in the [Setting Up Encoder Parameters](#) section and selected [Inch Linear Encoder](#), you are using **BT** or **JB** linear encoders (inch linear encoders) for feedback.

The DRO prompts for the encoder resolution and direction of positive travel in the message window:

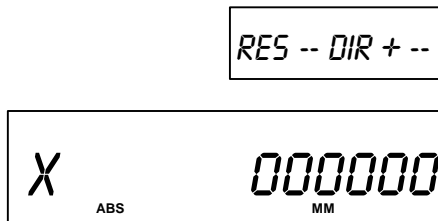

The axis designation (in this example, **X**) is blinking, indicating that you can enter a value. The default value for the encoder resolution is **.0001 in.** (The display shows the value in ten thousands of an inch). This value must be exact for the specific encoder you are using for feedback.

**NOTE:** If you do not know the exact encoder resolution, call ANILAM for advice.

If you need to change the encoder resolution setting:

1. Enter the correct setting (in ten thousands of an inch) for the encoder you are using.

For example, if the encoder resolution is **.0002 in.** (two thousands of an inch):

2. Press 

If you need to change the direction of positive travel:

3. Press 

to change the direction of positive travel.

4. Proceed to step 6 in the **Metric Linear Encoders** section and follow the procedures.

## Parameter Settings – F 20 (Continued)

### Rotary Encoders

If you have performed steps 1 through 3 in the **Setting Up Encoder Parameters** section and selected Rotary Encoder (**rot**), the DRO prompts for the Line Count in the message window. The default rotary encoder line count (**9000**) is displayed in the axis display:

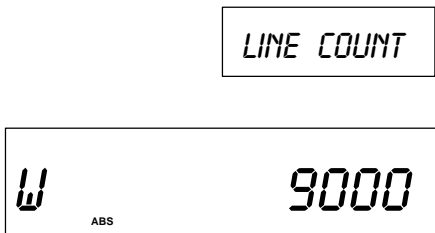

The axis designation (in this example, **W**) is blinking, indicating that you can enter a value. The default value for the encoder line count is **9000**. This value must be exact for the specific encoder you are using for feedback.

If you need to change the line count:

1. Enter the correct setting for the rotary encoder you are using.

If you need to change the direction of positive rotation:

2. Press  to change the direction of positive rotation.
3. Press  to set the encoder line count.

## Parameter Settings – F 20 (Continued)

The DRO displays the following in the message window and the axis display:

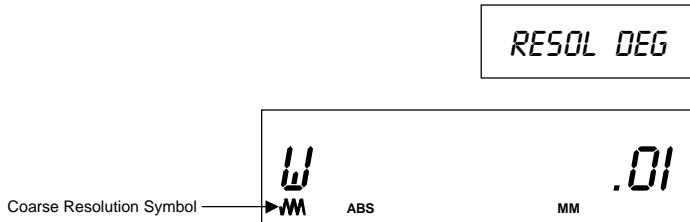

This setting is for the resolution of the axis display(s) when you set the DRO to display Degrees in Decimal mode only. The axis designation (in this example, **W**) is blinking, indicating that you can enter a value. The DRO will default the same display resolution as the encoder resolution (in this example, **.01 Degrees**). ANILAM recommends that you use the same display resolution as the encoder resolution.

4. Press  to scroll through the display resolution options for Degrees in Decimal mode.

The display resolution options for Degrees in Decimal mode are:

.0005, .001, .002, .005, .01, .02, .05, .1, .2, .5, 1 **Degrees**

**NOTE:** If the selected display resolution is coarser than the encoder resolution, the DRO turns on the Coarse Resolution Symbol in the axis display(s).

5. Press  to select the desired display resolution option in Degrees in Decimal mode.

## Parameter Settings – F 20 (Continued)

The DRO displays the following in the message window and the axis display:

MIN--SEC

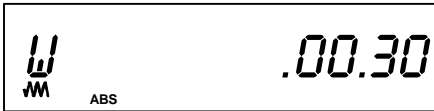

This setting is for the resolution for the axis display(s) when you set the DRO to display Degrees in Minutes and Seconds mode only. The axis designation (in this example, **W**) is blinking, indicating that you can enter a value. The DRO will default the display resolution that best matches the encoder (in this example, **30 seconds**). ANILAM recommends that you use the display resolution that best matches the encoder resolution.

6. Press



to scroll through the display resolution options for Degree in Minutes and Seconds mode.

The display resolution options for Degrees in Minutes and Seconds mode are:

.00.01, .00.02, .00.05, .00.10, .00.20, .00.30, .01, .02, .05, .10, .20 **Min.Sec**

**NOTE:** If the selected display resolution is coarser than the encoder resolution, the DRO turns on the Coarse Resolution Symbol in the axis display(s).

7. Press



to select the desired display resolution option for Degrees in Minutes and Seconds mode, and exit the feature.

## Parameter Settings – F 20 (Continued)

To reset all parameter settings to the original factory configuration:

8. Press  for approximately 5 seconds (Press F again to cancel the reset).
9. Press  to reset all parameters.

## Display Dim OFF/ON – F 22/F 23

**F 22** allows you to activate Dim Mode; **F 23** allows you to deactivate Dim Mode. To increase the life of the display, the DRO automatically dims if it is not used for 15 minutes (similar to a computer terminal's screen-saver mode). When you activate Dim Mode the axis displays show blinking decimal points. The DRO remains in Dim Mode until you press a key or move one or more linear encoders. (Default: ON)

To select DIM ON:

1. Press   

The DRO displays the following in the message window:

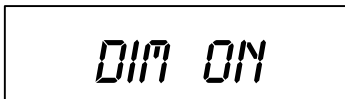

*DIM ON*

To select DIM OFF:

1. Press   

The DRO displays the following in the message window:

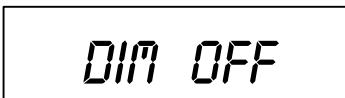

*DIM OFF*

**NOTE:** You can disable this feature, however the DRO still goes into Dim Mode after standing idle for one hour.

## Axis Designation – F 24

**F 24** allows you to assign an axis to each display you select. You can change the assignment of any axis to **X, Y, Z, W, Z<sub>1</sub>, X<sub>1</sub>** or no axis designation.

1. Press    to select the feature.

The DRO displays the following in the message window and axis display:



NAME AXIS



X F24

2. Press the desired axis key to scroll through the available settings.

3. Press  to activate the axis assignment.

OR

4. Press  to exit without changing the axis assignment.

## Select Language – F 99

**F 99** allows you to select the language the DRO will use to display text and messages.

The available languages are:

- English
- German
- French
- Italian
- Spanish
- Swedish
- Czech
- Portuguese

To select the language:

1. Press



The DRO displays the selected language in the message window:

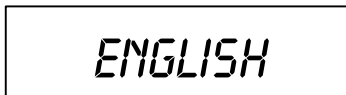

2. Press



to scroll through the options.

3. Press



to select the language.



## Linear Encoder Error Detect OFF/ON – F 40/F 41

Your DRO has advanced Linear Encoder error-checking capability. This feature determines if there are any Linear Encoder miscounts or repeatability problems. **F 40** allows you to turn OFF Linear Encoder Error Detect; **F 41** allows you to turn ON Linear Encoder Error Detect. (Default: ON)

To turn OFF the Linear Encoder Error Detect feature and deactivate all axes:

1. Press   

The DRO momentarily displays the following in the message window:



*ENCERR OFF*

To turn ON Linear Encoder Error Detect and activate all axes:

1. Press   

The DRO momentarily displays the following in the message window:



*ENCERR ON*

If the DRO detects an error, it displays the error in that axis display. The other axis displays remain blank for a short time and then the beeper sounds.

For example:

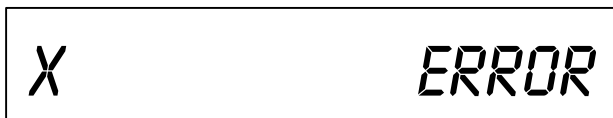



*X* *ERROR*

# Diagnostics – F 45

**F 45** allows you to perform system diagnostic tests on the keyboard, internal EEPROM, and internal counters. If any of these tests fail, contact your local distributor or ANILAM Customer Services. You do not need to unplug the linear encoders for these tests.

## Display Test

1. Press   

to display all segments of the display and message window.

## EEProm Test

2. Press 

to activate the internal EEPROM test.

The DRO displays the results in the axis window:

***EEProm nF*** (no fail).

***EEPR. FAIL***

## Counters Test

3. Press 

to activate the internal counters test.

The DRO displays the results in the axis window:

***Count nF*** (no fail).

***CNT FAIL***

## Diagnostics – F 45 (Continued)

### Keyboard Test

4. Press  to activate the keyboard test.
5. Press any key on the DRO to display the key on the DRO display.

### Blank Test

6. Press  for 2 seconds to blank all segments of the display.
7. Press  to end the system diagnostics test.

# Advanced (ADV) Functions Key

The Advanced Functions Key allows you to access the following DRO advanced functions:

- ❑ [Help for DRO Features](#)
- ❑ [Bolt-Hole Patterns \(450 only\)](#)
- ❑ [Linear-Hole/Frame Hole Patterns \(450 only\)](#)
- ❑ [Taper Calculation \(450L only\)](#)

To access the Advanced functions:

1. Press 

The DRO displays the following in the message window:



*HELP*

To scroll through the functions list:

2. Press 

## Help Function

**HELP** allows you to scroll through a list of feature names and their codes or quickly access a DRO feature from the list.

To display the list of features and their codes:

1. Press 

The DRO displays the following in the message window:

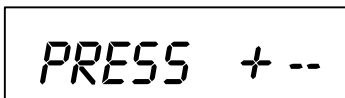

*PRESS + --*

## Advanced (ADV) Functions Key (Continued)

To scroll through the feature list:

2. Press 



The DRO displays the following in the message window and axis display 1:

*ABS SET*

*F01*

Each time you press the plus/minus key, the DRO displays the next feature code in axis display 1 and the feature name in the message window.

To reverse the scrolling direction:

3. Press  

To activate a displayed feature:

4. Press 

To exit the Help function:

5. Press 

# Advanced (ADV) Functions Key (Continued)

## Bolt-Hole Pattern Function (450 Only)

The **Bolt-Hole Pattern** function allows you to program the X and Y positions for a maximum of 10 different bolt-hole patterns (maximum 360 holes each) around the circumference of a specified circle. The 450 DRO can program the following types of bolt-hole patterns:

- Partial Pattern      In a partial pattern, the holes do not cover the entire circumference of the circle. Instead they form an arc, called a partial pattern. (See Figure 1)
- Full Pattern        In a full pattern, the holes cover the entire circumference of the circle. (See Figure 2)

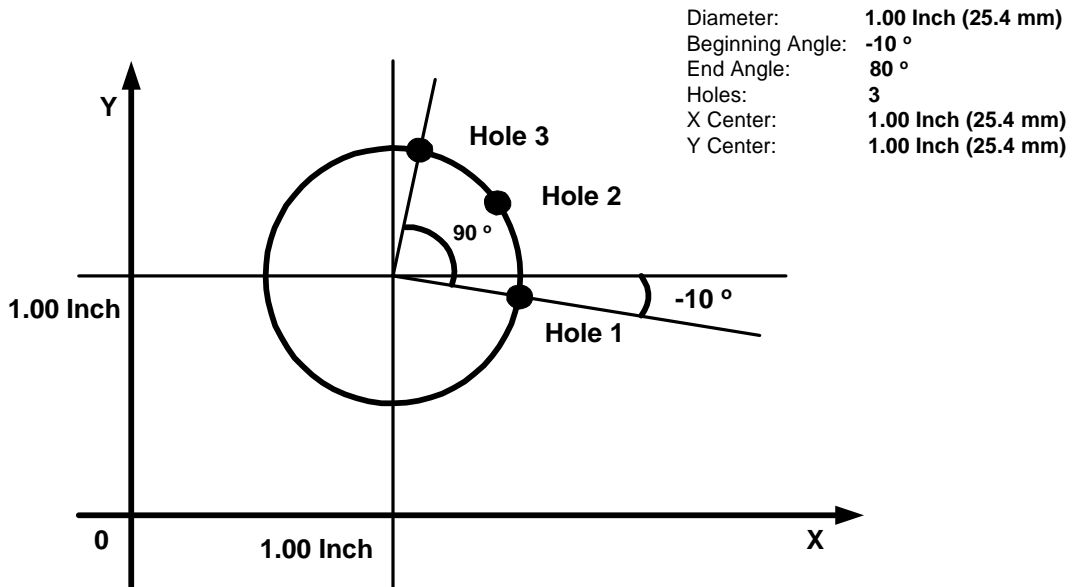

Figure 1: Partial Bolt-Hole Pattern

## Advanced (ADV) Functions Key (Continued)

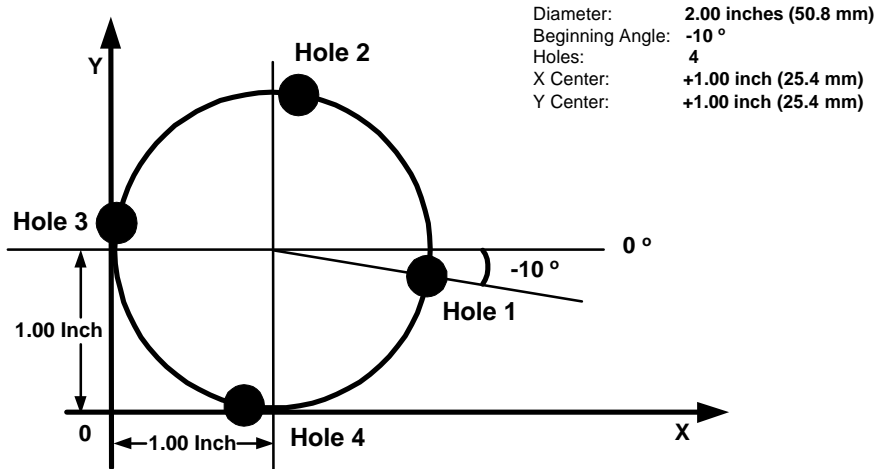

Figure 2: Full Bolt-Hole Pattern

To access the Bolt-Hole pattern function:

1. Press **ADV** **ADV** to scroll through the Advanced Functions list.

When the DRO displays the following in the message window:

**BOLT HOLE**

2. Press **ENT**

The DRO displays the following in the message window:



**BHP NUMBER**

## Advanced (ADV) Functions Key (Continued)

**Note:** If you are entering a full bolt-hole pattern, skip this section and go to the [Full Bolt-Hole Pattern](#) section.

### Partial Bolt-Hole Pattern

To enter a partial bolt-hole pattern for program number 1 (Range is 0 through 9):

1. Press  

The DRO displays the following in the message window:



*FULL*

To enter a partial bolt-hole pattern:

2. Press 

The DRO displays the following in the message window:



*PARTIAL*

3. Press 

The DRO displays the following in the message window and axis display 1:



*X CENTER*

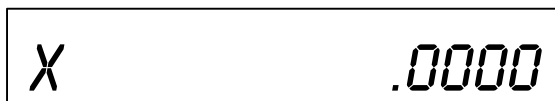

*X .0000*



## Advanced (ADV) Functions Key (Continued)

To enter the X dimension for the center of the pattern. For example, **1.00** inch (**25.4** mm):

4. Press  

The DRO displays the following in the message window and axis display 2:

*Y CENTER*

*Y* *.0000*

To enter the Y dimension for the center of the pattern. For example, **1.00** inch (**25.4** mm):

5. Press  

The DRO displays the following in the message window and axis display 1:

*BHP DIA*

*X* *.0000*

To enter the diameter of the bolt-hole pattern. For example, **1.00** inch (**25.4** mm):

6. Press  

## Advanced (ADV) Functions Key (Continued)

The DRO displays the following in the message window and axis display 1:

*QTY HOLE*

*X*

*0*

To enter the number of bolt-hole patterns (maximum 360 holes). For example, **3**:

**3**

**ENT**

7. Press

The DRO displays the following in the message window and axis display 1:

*BEG ANGLE*

*X*

*.0000*

To enter the beginning angle for the first hole (measured in a counter clockwise direction)  
For example: **-10** degrees

**±**

**1**

**0**

**ENT**

8. Press

The DRO displays the following in the message window and axis display 1:



*END ANGLE*

*X*

*360.0*

## Advanced (ADV) Functions Key (Continued)

To enter the end angle for the pattern (measured in a counter clockwise direction), for example, for **80** degrees:

9. Press   

The DRO temporarily displays the following in the message window:



*BHP DONE*

## Advanced (ADV) Functions Key (Continued)

### Full Bolt-Hole Pattern (450 Only)

To access the Full Bolt-Hole Pattern function:

1. Press   to scroll through the Advanced Functions list.

When the DRO displays the following in the message window:

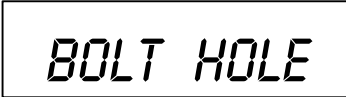

*BOLT HOLE*



2. Press 

The DRO displays the following in the message window:



*BHP NUMBER*

To enter a full bolt-hole pattern for program number **2** (Range is **0** through **9**):

3. Press  

The DRO displays the following in the message window:



*PARTIAL*

4. Press 

## Advanced (ADV) Functions Key (Continued)

The DRO displays the following in the message window:

*FULL*

**ENT**

5. Press

The DRO displays the following in the message window and axis display 1:

*X CENTER*

*X* *.0000*

To enter the X dimension for the center of the pattern. For example, **1.00** inch (**25.4** mm):

**1**

**ENT**

6. Press

The DRO displays the following in the message window and axis display 2:

*Y CENTER*

*Y* *.0000*

To enter the Y dimension for the center of the pattern. For example, **1.00** inch (**25.4** mm):

**1**

**ENT**

7. Press

## Advanced (ADV) Functions Key (Continued)

The DRO displays the following in the message window and axis display 1:

*BHP DIA*

X

.0000

To enter the diameter of the bolt-hole pattern. For example, **2.00** inches (**50.8** mm):

2

ENT

8. Press

The DRO displays the following in the message window and axis display 1:

*QTY HOLE*

X

0

To enter the number of bolt-hole patterns (maximum 360 holes). For example, **4**:

4

ENT

9. Press

The DRO displays the following in the message window and axis display 1:





*BEG ANGLE*

X

.0000

## Advanced (ADV) Functions Key (Continued)

To enter the beginning angle for the first hole (measured in a counter clockwise direction)  
For example: **-10** degrees

10. Press    

The DRO temporarily displays the following in the message window:



*BHP DONE*

## Advanced (ADV) Functions Key (Continued)

### Recalling Bolt-Hole Pattern Function (450 Only)

The Recall Key (**RCL**) allows you to recall a maximum of 10 previously programmed bolt-hole patterns.

To recall bolt-hole pattern number **1** programmed in the previous section:

1. Press   to scroll through the Advanced Functions list.

When the DRO displays the following in the message window:

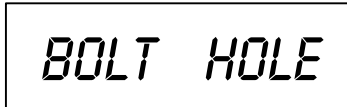



*BOLT HOLE*

2. Press 

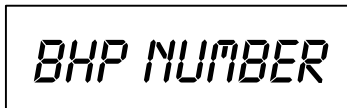
The DRO displays the following in the message window:



*BHP NUMBER*

3. Press  



## Advanced (ADV) Functions Key (Continued)

The DRO displays the following in the message window and the axis displays:

1 HOLE 001

X -1.4924

Y - .9132

The message window indicates bolt-hole pattern number 1 and hole number 1. The axis displays show the distance to hole number 1.

4. Move the machine until the axis displays indicate zero and drill the hole.

To recall the distance to hole number 2:

RCL

5. Press

The DRO displays the following in the axis displays and the message window:

2 HOLE 002

X +.0828

Y - .3736

## Advanced (ADV) Functions Key (Continued)

The message window indicates bolt-hole pattern number **2** and hole number **2**. The axis displays show the distance to hole number **2**.

6. Move the machine until the axis displays indicate zero and drill the hole.

To recall the distance to hole number **3**:

7. Press 

The DRO displays the following in the axis displays and the message window:

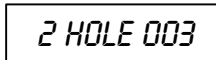

2 HOLE 003



X +.3228



Y -.2056

After you drill the last hole in the pattern the DRO returns to hole **1** and displays the following in the message window:

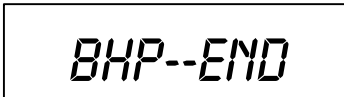

BHP--END

The DRO displays the incremental distance from the absolute zero position in the axis displays.

To exit the Recall function:

8. Press 

# Advanced (ADV) Functions Key (Continued)

## Linear-Hole/Frame-Hole Pattern Function (450 Only)

The **Linear Hole** function allows you to program a combination of 10 different linear-hole patterns or frame-hole patterns. Each pattern can include a maximum of 999 holes.

To access the Linear-Hole function:

1. Press    to scroll through the Advanced Functions list.

When the DRO displays the following in the message window:

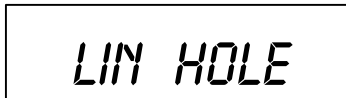

LIN HOLE

2. Press 

The DRO displays the following in the message window:



LHP NUMBER

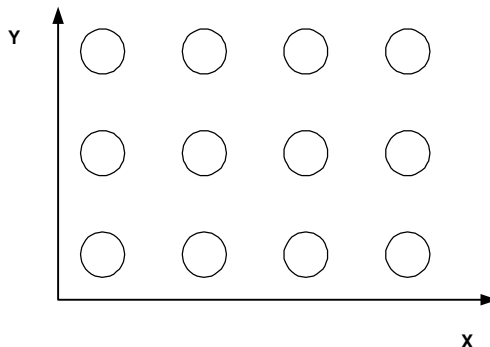

Figure 3: Linear-Hole Pattern

## Advanced (ADV) Functions Key (Continued)

To program a linear-hole pattern (For example, linear-hole pattern number **3** (Range is **0** through **9**):

3. Press **3**

The DRO displays the following in the message window:

*LIN HOLE*

If you are programming a linear-hole pattern go to step 5.

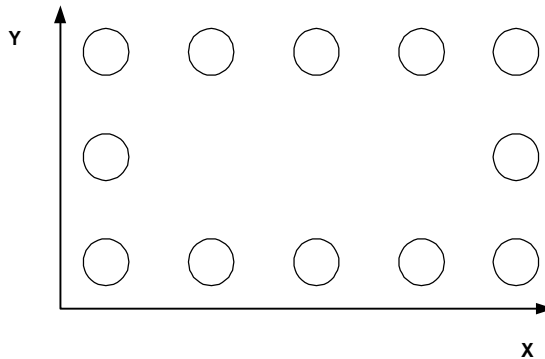

**Figure 4: Frame-Hole Pattern**

To select Frame-Hole Pattern:

4. Press **+**

The DRO displays the following in the message window:

*FRAME HOLE*

## Advanced (ADV) Functions Key (Continued)

To enter a frame-hole pattern:



5. Press 

The DRO displays the following in the message window:



X HOLE 1

To enter the dimension for hole 1 on the X-axis. For example, **1.00** inch (**25.4** mm):



6. Press  

The DRO displays the following in the message window:



Y HOLE 1

To enter the dimension for hole 1 on the Y-axis. For example, **1.00** inch (**25.4** mm):

7. Press  

## Advanced (ADV) Functions Key (Continued)

The DRO displays the following in the message window:

*QTY HOLE X*

To enter the number of holes on the X-axis. For example, **4**:

8. Press

The DRO displays the following in the message window:

*X -- X CENT*

To enter the incremental distance between holes on the X-axis. For example, **1.00** inch (**25.4** mm):

9. Press

The DRO displays the following in the message window:

*QTY HOLE Y*

To enter the number of holes on the Y-axis. For example, **4**:



10. Press

## Advanced (ADV) Functions Key (Continued)

The DRO displays the following in the message window:

*Y --Y CENT*

To enter the incremental distance between holes on the Y-axis. For example, **1.00** inch (**25.4** mm):

11. Press  

The DRO displays the following in the message window:

*X004 Y004*

The message window indicates the calculated holes in the X-axis (4 holes) and the Y-axis (4 holes). This equals a total of 16 holes (4 X-holes x 4 Y-holes). The maximum number of holes you can program is 999 holes.

To activate the settings and exit the Frame Hole function:

12. Press 

**OR**

To exit the Frame-Hole function without activating the settings:

13. Press 

## Advanced (ADV) Functions Key (Continued)

### Recalling Linear-Hole/Frame-Hole Function (450 Only)

The Recall Key (**RCL**) allows you to recall a maximum of 10 previously programmed linear bolt-hole patterns.

To recall linear-hole pattern number **3** programmed in the previous section:

1. Press    to scroll through the Advanced Functions list.

When the DRO displays the following in the message window:

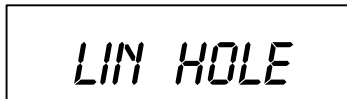

*LIN HOLE*

2. Press 

The DRO displays the following in the message window:

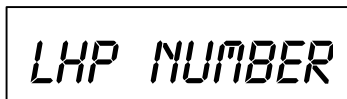

*LHP NUMBER*

To recall linear-hole pattern number **3** programmed in the previous section:

3. Press 



## Advanced (ADV) Functions Key (Continued)

The DRO displays the following in the axis displays and the message window:

1 HOLE 001

X -1.9848

Y -.8264

The message window indicates bolt-hole pattern number 1 and hole number 1. The axis displays show the distance to hole number 1.

4. Move the machine until the axis displays indicate zero and drill the hole.

To recall the distance to hole number 2:

RCL

5. Press

The DRO displays the following in the axis displays and the message window:

2 HOLE 002

X +.8110

Y -1.1584

## Advanced (ADV) Functions Key (Continued)

The message window indicates bolt-hole pattern number **2** and hole number **2**. The axis displays show the distance to hole number **2**.

6. Move the machine until the axis displays indicate zero and drill the hole.
7. Repeat these procedures until you have completed all holes in the linear-hole pattern.

To exit the Recall Linear-Hole Pattern function:

8. Press 

## Advanced (ADV) Functions Key (Continued)

### Taper Calculator Function (450L Only)

The **Taper Calculator** function allows you to preset a taper angle on the lathe cross slide attachment without having to make a test cut. This function can also be used to calculate the taper on a workpiece.

To access the Taper Calculator function:

1. Press   to scroll through the Advanced Functions list.

When the DRO displays the following in the message window:

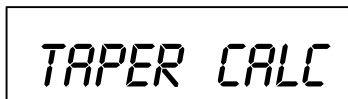

TAPER CALC

2. Press 

The DRO displays the following in the message window:

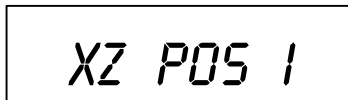

XZ POS 1

**Example:**

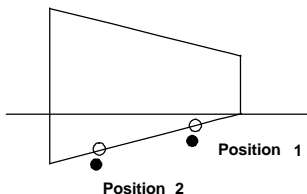

To calculate the taper angle for this example:

3. Move to position 1.

## Advanced (ADV) Functions Key (Continued)

4. Press 

The DRO displays the following in the message window:



XZ POS 2

5. Move to position 2.

6. Press 

The DRO displays the taper angle in the message window:

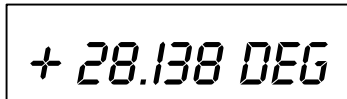

+ 28.138 DEG

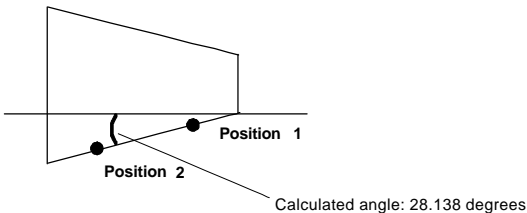

To exit the Taper Calculator function:

7. Press  or 

## Datum Key (450 Only)

The Datum Key allows you to enter a datum table (maximum 99 datum points). A datum is a point or reference location, from which you can machine a part. Datum points allow you to machine similar programs on different parts. After you machine a group of parts, you can place a new group on the machine and machine the same programs on the new parts.

**Note:** Before you enter a datum table you must establish a machine home position using [Absolute Zero Set – F 01](#) or activate [EverTrack™ Mode – F 02](#).

**Example:**

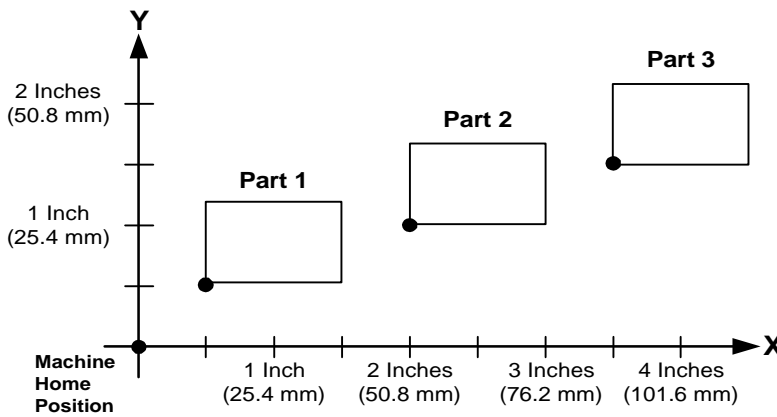

### Enter Datum

To enter a datum table for the above example:

1. After power on, establish a machine home position using [Absolute Zero Set – F 01](#) or activate [EverTrack™ Mode – F 02](#).
2. Move the tool to the home position (indicated by the black dot).
3. Establish a part zero using [Absolute Zero Set – F 01](#).

Datum 0, machine home is set.



4. Move the tool to the corner of part 1 (indicated by the black dot).

## Datum Key (450 Only) (Continued)

5. Press 

The DRO displays the following in the message window:

*DATUM 00*

6. Press  

The DRO displays the following in the message window:

*DATUM 01*

7. Establish a part zero using [Absolute Zero Set – F 01](#).



Datum 1 is set.

8. Move the tool to the corner of part 2 (indicated by the black dot).

9. Press 

The DRO displays the following in the message window:

*DATUM 01*

10. Press  

## Datum Key (450 Only) (Continued)

The DRO displays the following in the message window:



DATUM 02

11. Establish a part zero using [Absolute Zero Set – F 01](#).

Datum 2 is set.

12. Move the tool to the corner of part 3 (indicated by the black dot).



13. Press

The DRO displays the following in the message window:



DATUM 02

0

3

14. Press

The DRO displays the following in the message window:



DATUM 03

15. Establish a part zero using [Absolute Zero Set – F 01](#).

Datum 3 is set.



## Datum Key (450 Only) (Continued)

### Enter Datum (Alternate Method)

If you know the axis locations for the corner of the parts, you can enter the datum table for the previous example without moving the tool from the machine home position as follows:

1. After power on, establish a machine home position using [Absolute Zero Set – F 01](#) or activate [EverTrack™ Mode – F 02](#).

To enter datum 1:

2. Press   
3. Press the axis key for the X-axis.



4. Press   to enter the X-axis value, .5 inch (12.7 mm).

5. Press the axis key for the Y-axis.

6. Press   to enter the Y-axis value, .5 inch (12.7 mm).

7. Press  to set datum 1.

To enter datum 2:

8. Press   



## Datum Key (450 Only) (Continued)

9. Press the axis key for the X-axis.



10. Press  to enter the X-axis value, 2 inches (50.8 mm).

11. Press the axis key for the Y-axis.

12. Press  to enter the Y-axis value, 1 inch (25.4 mm).

13. Press  to set datum 2.

To enter datum 3:

14. Press   

15. Press the axis key for the X-axis.

16. Press    to enter the X-axis value, 3.5 inches (88.9 mm).

17. Press the axis key for the Y-axis.

18. Press    to enter the Y-axis value, 1.5 inches (38.1 mm).

19. Press  to set datum 3.

## Datum Key (450 Only) (Continued)

### Recall Datum

Recall Datum allows you to recall a preset datum.

**Example:** To recall datum 1 from the previous example:

1. Press   

While the datum is activated, the DRO displays the following in the message window:



DATUM 01

2. Move the X-axis and Y-axis until the axis displays indicate zero (0).

This is the location for Datum 1.

3. Perform the machine process on part 1.

To return to the machine home position (datum 0):

4. Press   

5. Move the X-axis and Y-axis until the axis displays indicate zero (0).

This is the location for the machine home position (datum 0).

## Datum Key (450 Only) (Continued)

### Clear Datum – F 31

Clear Datum (F 31) allows you to clear all preset datum points (maximum 99) before entering new information.

To clear all datum points:

1. Press   

The DRO temporarily displays the following in the message window:

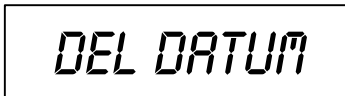

*DEL DATUM*

When the DRO resets the message window and axis displays, all preset datum values are cleared from memory.

## Tool Offset Key (450L Only)

The Tool Offset Key allows you to preset X and Z offsets for each tool into a tool table (maximum 99). This feature requires an interchangeable tool system.

**Note:** Before entering a tool offset you must establish a machine home position using [Absolute Zero Set – F 01](#) or activate [EverTrack™ Mode – F 02](#).

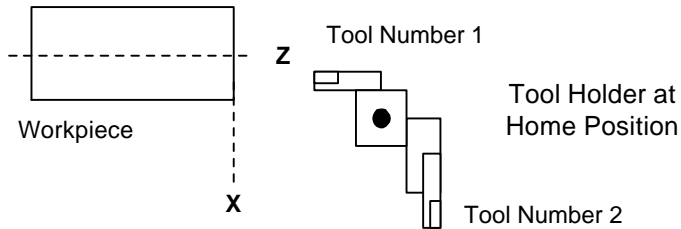

### Enter Tool Offset



**Example:** To enter an offset for a tool:

1. Press 

The DRO displays the following in the message window:

*TOOL 00*

To select the tool number, (For example, tool number 1):

2. Press  

The DRO displays the following in the message window:

*TOOL 01*

## Tool Offset Key (450L Only) (Continued)

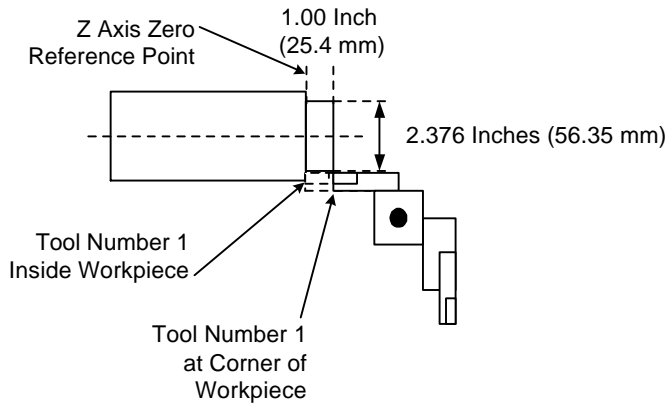

3. Move the tool to the workpiece and make a skim cut on the diameter, about 1 inch (25.4 mm), to allow a micrometer to measure the workpiece.
4. Measure the diameter of the workpiece. The measurement in the example is 2.376 inches (56.35 mm).
5. Move the tool to the corner of the workpiece or any known position as illustrated in the example.

To preset the tool offset:

6. Press the axis key for the X-axis.

7. Press

8. Move the tool to the Z-axis reference point.

To store this reference point:

9. Press the axis key for the Z-axis.

10. Press

The offset for tool number 1 is preset.

## Tool Offset Key (450L Only) (Continued)

11. Repeat these procedures by touching each tool on the same reference point on the workpiece.

If you do not require tool offset for a tool:

12. Press   

The DRO displays the following in the message window:



*TOOL 00*

### Recall Tool Offset

Recall Tool Offset allows you to recall a previously set tool offset (Range: 1 through 99).

**Example:** To recall the preset tool offset for tool number 18:

1. Press   

While the tool is activated, the DRO displays the following in the message window:



*TOOL 18*

## Tool Offset Key (450L Only) (Continued)

### Modify Tool Offset – F 35

Modify Tool Offset (**F 35**) allows you to modify the Z-axis tool-offset value for all tools without reentering values. If you place a new part with a different length in the chuck, you must modify all the Z-axis tool offsets in the tool table.

**Note:** To modify the tool offset, a tool number must be activated.

**Example:** To modify the Z offset to **5.0**:

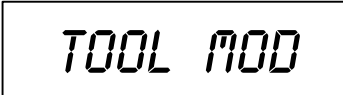

1. Press   

The DRO displays the following in the message window:



*TOOL MOD*

2. Press the axis key for the Z-axis.

3. Press    

to activate the feature.

## Tool Offset Key (450L Only) (Continued)

### Clear Tool Offset – F 32

Clear Tool Offset (F 32) allows you to clear all preset tool offset values (99 tools) before entering new information.

To clear all preset tool offset values:

1. Press   

The DRO displays the following in the message window:



*DEL TOOL*

When the DRO resets the message window and axis displays, all preset tool offset values are cleared from memory.



## Axis Coupling (450L, 3-Axis Only) – F 18

**F 18** allows you to sum two parallel axes (Z + Z1, Z + W, or Y + Z) on one axis. This allows you to move the coupled axes independently while the DRO automatically calculates the true tool position. This feature is valid only on three-axes DROs.

### Example:

To sum axis 2 and axis 3:

1. Press    to select the feature.

The DRO temporarily displays following in the message window:



*COUP ON*

The DRO clears the **COUP ON** message and displays the following in the message window:

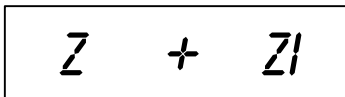

*Z + Z1*

To turn off axis coupling:

1. Press   

The DRO displays the following in the message window:

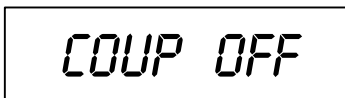

*COUP OFF*

## Output Connections (With I/O Option Only)

Output connections are located on the back of the DRO. When DRO functions are activated, the DRO generates signals through these connections to operate external devices.

Each output can sink 500 mA of current when active. The output load of Relay 1 and Relay 2 should be a maximum of 10 VA (maximum 20 Volts, 0.75 A).

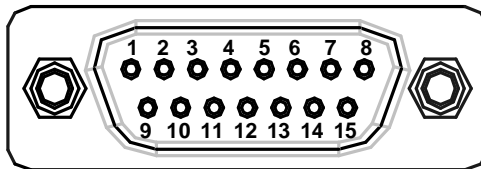

### DA 15 Connector (Male)

Pin 1	Relay 1 Output	Pin 9	Relay 2 Output
Pin 2	Relay 1 Output	Pin 10	Approaching Zero
Pin 3	X-Axis Zero	Pin 11	Y-Axis Zero
Pin 4	Z-Axis Zero	Pin 12	Relay 2 Output
Pin 5	W-Axis Zero	Pin 13	Ground
Pin 6	Ground	Pin 14	+24 Volts
Pin 7	+24 Volts	Pin 15	DAC Output for CSS
Pin 8	Analog Ground for DAC Output		(0-10 Volt/10mA, 12 Bit, galv. isolated)

The output connections, X-axis zero, Y-axis zero, Z-axis zero, W-axis zero, and approaching zero are enabled by applying a constant +24 VDC, 50 mA source to pin 7 and pin 14 and a ground to any of two ground pins.

When outputs are enabled, pin 3, pin 4, pin 5, and pin 11 generate a 24-V common signal as the corresponding axis value is zero. Pin 10 generates a 24-V common signal within a set range of an axis zero. The 24-V common output is generally used to complete a relay control circuit.

## Input Connections (With I/O Option Only)

Input connections are located on the back of the DRO. These connections allow signals from external devices to activate specific DRO functions.

DRO functions are activated by applying a +24 VDC, 10 mA signal for a minimum of 100 ms. Inputs to the DRO are optically coupled for protection. The Ground pin is the reference ground for the inputs and should always be used.

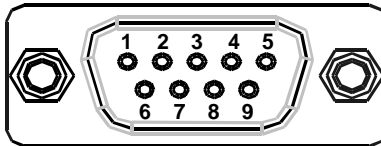

### DE 9 Connector (Male)

Pin 1	X-Axis Zero
Pin 2	Z-Axis Zero
Pin 3	Recall ( <b>RCL</b> Key for remote operations)
Pin 4	Not Used
Pin 5	Ground
Pin 6	Y-Axis Zero
Pin 7	Store ( <b>ENT</b> Key for remote operations)
Pin 8	Print
Pin 9	Not Used

## Zero Output ON/OFF (With I/O Option Only) – F 33

F 33 allows you to toggle the zero output ON or OFF. (Default: OFF)

To turn the zero output ON:

1. Press   

The DRO displays the zero output setting in each axis display and the following in the message window:



ZERO OUT

2. Press the desired axis key

to toggle the zero output setting ON or OFF.

3. Press 

to activate the setting.

## Approaching Zero Output Axis (With I/O Option Only) – F 14

**F 14** allows you to specify which axis the DRO will use for approaching zero (APZ) output. When the selected axis is within the range preset using [Approaching Zero Range – F 07](#), the DRO turns on the output.

To specify the axis for APZ output:

1. Press   

The DRO displays the following in the message window:

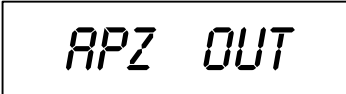

APZ OUT

**NOTE:** You can select only one axis for APZ output.

2. Press the desired axis key to toggle the axis ON.

The DRO displays the following in the selected axis display:



On

To exit without specifying the axis for APZ output:

3. Press 

To set the axis for APZ output:

4. Press 

## Zero Output Time Select (With I/O Option Only) – F 25

**F 25** allows you to specify the time for which a remote device is turned on when the selected axis crosses zero. (Default: 100 ms) [Zero Output – F 33](#) must be ON.

To change the setting:

1. Press    to select the feature.

The DRO displays the following in the message window:

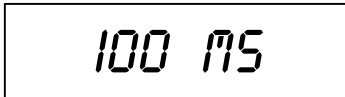

100 MS

The DRO displays the last-entered setting in the message window.

The available settings are:

### **Zero Output Time Settings**

30 ms, 100 ms (default), 200 ms, 300 ms,  
400 ms, 500 ms, 600 ms, 700 ms, 800 ms,  
900 ms, and 1 second

## RS-232 Interface (With I/O Option Only)

The RS-232 Interface connection is located on the back of the DRO. This connection allows you to exchange data with other RS-232 devices.

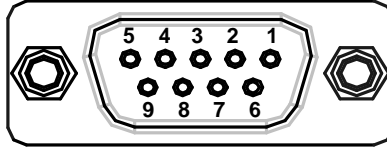

### DE 9 Connector (Female)

Pin 1	Not Used
Pin 2	<b>TxD</b> (Transmit Data)
Pin 3	<b>RxD</b> (Receive Data)
Pin 4	Not Used
Pin 5	Ground
Pin 6	Not Used
Pin 7	<b>CTS</b> (Clear-To-Send)
Pin 8	<b>RTS</b> (Request-To-Send)
Pin 9	Not Used



**NOTE:** Clear-To-Send (**CTS**) and Request-To-Send (**RTS**) are connected but have no function.

## RS-232 Setup (With I/O Option Only) – F 27

F 27 allows you to set up the following parameters for the RS-232 port:

- Baud Rate
- Parity
- Data Bits
- Printer or Computer Output

To set up RS-232 port parameters:

1. Press   

The DRO displays the following in the message window:

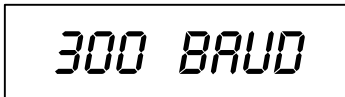

300 BAUD

The available baud rates are:

### RS-232 Baud Rates

300 (default), 600, 1200, 2400,  
4800, 9600, 19200, 38400



## RS-232 Setup (With I/O Option Only) – F 27 (Continued)

The available selections are:

- NO PARITY (default)
- EVEN PARITY
- ODD PARITY

4. Press



to scroll through the options.

5. Press



to set the parity.

The DRO displays the following in the message window:

8 DATA--BIT

The available selections are:

- 8 Data Bit (default)
- 7 Data Bit

**NOTE:** If you selected *NO PARITY*, you can only select **8 DATA-BIT**.

6. Press



to scroll through the options.

7. Press



to set the data bits.

## RS-232 Setup (With I/O Option Only) – F 27 (Continued)

The DRO displays the following in the message window:

***PRINTER***

The available selections are:

- PRINTER** (default)      Each output of a string ends with a Carriage Return (CR) and a Line Feed (LF).
- COMPUTER**              Each output of a string ends with a Carriage Return (CR).

8. Press  to toggle between the options.

9. Press  to set the output.

**OR**

10. Press  to exit without change.

## RS-232 ON/OFF (With I/O Option Only) – F 28

F 28 allows you to toggle the RS-232 port ON or OFF. (Default: OFF)

To toggle the RS-232 port ON:

1. Press   

The DRO displays the following in the message window:



RS 232 ON

To toggle the RS-232 port OFF:

1. Press   

The DRO displays the following in the message window:







RS 232 OFF

## Printing Axis Values (With I/O Option Only)

**NOTE:** Before sending data to the printer, ensure that the DRO is not in the Preset Mode.

To print axis values to a printer:

1. Press  to print the data from axis 1.
2. Press  to print the data from axis 2.
3. Press  to print the data from axis 3.
4. Press  to print the data from all axes.

### Printed Axis Value Format

The DRO prints the axis values in the following format:

*Axis value unit of measurement counting mode diameter mode*

**Examples:**

X	-123.456	mm	ABS	D	
Y	454.902	in	INC		
W	-235.125	dms			(dms = degree-min-sec)

## Remote Operation (With I/O Option Only)

You can remotely operate the DRO from an IBM-compatible computer running a terminal program via the RS-232 Interface connection. The baud rate, parity, and data bit settings of the DRO and the terminal (or computer) must agree, and RS-232 must be ON. After you activate the RS-232 link, you can operate the DRO by pressing the computer keyboard.

DRO Keypad	Computer Keyboard Equivalent	DRO Keypad	Computer Keyboard Equivalent	DRO Keypad	Computer Keyboard Equivalent
Axis Key 1	X		T		4
Axis Key 2	Y		C		5
Axis Key 3	Z		I		6
			M		7
	S		-		8
	E		.		9
	R		0	Reset all Axes	P
	F		1	XON	J
	D		2	XOFF	N
	A		3		
	G90		G91		
(Absolute)		(Incremental)			
	G70		G71		
(Inch)		(Metric)			

## Relay 1/Relay 2 Setup (With I/O Option Only) – F 38/F 39

**F 38** and **F 39** allow you to set up the parameters for Relay 1 and Relay 2.

The following procedures for setting up parameters for Relay 1 also can be used to set up parameters for Relay 2. Substitute **F 39** to set up Relay 2.

To set up Relay 1:

1. Press   

The DRO displays the following in the message window:

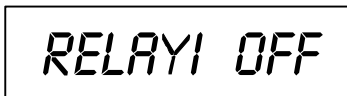

RELAY1 OFF

2. Press 

to toggle Relay 1 ON.

3. Press 

The DRO displays the following in the message window:

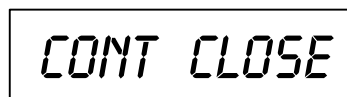

CONT CLOSE

4. Press 

to toggle contact OPEN.

5. Press 

The DRO displays the following in the message window:

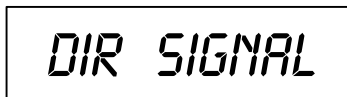

DIR SIGNAL

## Relay 1/Relay 2 Setup (With I/O Option Only) – F 38/F 39 (Continued)

6. Press  to toggle between Direct Signal and Coincidence Pulse.

7. Press  If you select Coincidence Pulse, you can change the output time. The available output times for Coincidence Pulse are:

### Coincidence Pulse Output Time

100 ms (default), 500 ms, 1 sec,  
2 sec, 3 sec, 4 sec, 5 sec, 10 sec,  
30 sec, 1 min, 2 min, 5 min, 10 min

8. Press  to scroll through the options.

9. Press  to select the Coincidence Pulse output time.

The DRO displays the following in the message window:



*SEL AXIS*

# Relay 1/Relay 2 Setup (With I/O Option Only) – F 38/F 39 (Continued)

10. Press the desired axis key.

11. Press **5** **.** **2** **0** **SET** to enter the value for the switch off point.

**NOTE:** You can assign each relay to each axis.





## Output Test (With I/O Option Only) – F 42

F 42 allows you to test the following available DRO outputs:

- ❑ X ZERO OUT
- ❑ Y ZERO OUT
- ❑ Z ZERO OUT
- ❑ APZ OUT
- ❑ RELAY 1
- ❑ RELAY 2

If any of these tests fail, contact your local distributor or ANILAM Customer Services.

To start the output tests:

1. Press   

The DRO turns on each available output for approximately 1 second. The message window displays the name of each output test and the beeper sounds a short beep when each test is complete.

To return to normal operation:

2. Press 

## Constant Surface Speed (CSS) Setup (450L With CSS and I/O Options)

If your DRO has the CSS option, you can use the DAC (Digital/Analog Converter) output voltage to control the spindle speed. You can vary the DAC output voltage between 0V and 10V with 12-bit resolution. A maximum of 5 different gears can be set up.

Use the following F-codes to set up the CSS feature:

[F 96](#)   [DAC Output Voltage Setup](#)

[F 97](#)   [DAC Output Voltage Offset Adjustment](#)

[F 98](#)   [DAC Output Voltage Test](#)

## DAC Output Voltage Setup (450L With CSS and I/O Options) – F 96

F 96 allows you to set up the DAC output voltage.

To set up the CSS feature:

1. Press **F** **9** **6** to select DAC voltage setup.

The DRO displays the following in the message window:

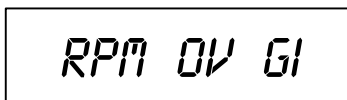

RPM 0V G1

prompting for the spindle speed at 0V for Gear 1.

To enter the spindle speed at 0V for Gear 1 (For example, 0 RPM):

2. Press **0** **SET**

The DRO displays the following in the message window:

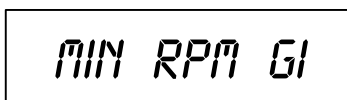

MIN RPM G1

prompting for the minimum spindle speed at 0V for Gear 1.

To enter the minimum allowed spindle speed for Gear 1 (For example, 25 RPM):

3. Press **2** **5** **SET**

## DAC Output Voltage Setup (450L With CSS and I/O Options) – F 96 (Continued)

The DRO displays the following in the message window:

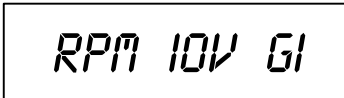

RPM 10V G1

prompting for the spindle speed at 10V for Gear 1.

To enter the spindle speed at 10V for Gear 1 (For example, 2000 RPM):

4. Press

5. Repeat steps 1 through 4 for each existing gear range (maximum 5).



**NOTE:** Spindle speed refers to the speed of the spindle, not the spindle motor.

## DAC Output Voltage Offset Adjustment (450L With CSS and I/O Options) – F 97

F 97 allows you to adjust the DAC output voltage offset. You will require a digital multimeter to perform this feature.

To set up the CSS feature:

1. Connect a multimeter to Pin 15 and Pin 8 and measure the DAC output voltage.

2. Press   

The DRO displays the following in the message window:

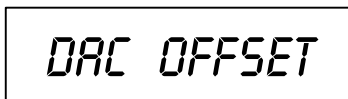

DAC OFFSET

The DRO displays a value between 0 and 50 in the axis display. To change the output voltage, change this value.

To adjust the DAC offset to exactly 0mV:

3. Press  repeatedly until the multimeter indicates 0 mV.

To reverse the scrolling direction:

4. Press  

To enter the adjusted DAC output voltage:

5. Press 

# DAC Output Voltage Test (450L With CSS and I/O Options) – F 98

F 98 allows you to verify the DAC output voltage setting.

To verify DAC output voltage setting:

1. Connect a multimeter between Pin 15 and Pin 8 and measure the DAC output voltage.

2. Press   

The DRO displays the following in the message window:

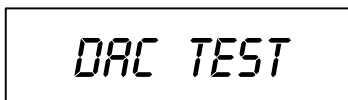

DAC TEST

3. Press  to display 0V on the axis display.

4. Press  to display 5V on the axis display.

5. Press  to display 10V on the axis display.

**NOTE:** The displayed DAC output voltage must be within 100mV of the nominal values.

## Constant Surface Speed (CSS)/Direct RPM Operation (450L With CSS and I/O Options)

If your DRO has the CSS option, you can use the DAC (Digital/Analog Converter) output voltage to control the spindle speed. You can use this feature in Lathe Mode to obtain a constant surface speed as the tool changes the workpiece diameter.

Use the following F-codes to operate the CSS feature:

[F 48](#)   [CSS/Direct RPM Input](#)

[F 50](#)   [DAC Output Voltage On/Off](#)

**NOTE:** The CSS feature must be set up properly.

**NOTE:** Do not start the spindle with the DRO (For example, using **F 50**). The machine should have a separate switch for this purpose.

## CSS/Direct RPM Input (450L With CSS and I/O Options) – F 48

**F 48** allows you to specify the desired Constant Surface Speed (CSS), which is entered in Feet per Minute (**INCH** Mode) or Meters per Minute (**MM** Mode). The DRO maintains the specified constant surface speed as the diameter of the workpiece changes. You can specify a maximum spindle speed (**MAX SPEED**) to restrict the spindle speed from exceeding this speed as the diameter decreases, or a specific spindle speed (**DIRECT RPM**) to maintain the spindle speed at a constant RPM.

To program a CSS operation:

1. Select a tool by using the Tool Offset.

2. Press



The DRO displays one of the following in the message window (depending on the number of available gears):

*GEAR 1*

*GEAR 2*

3. Press



to toggle and select the desired gear.

The DRO displays the following in the message window:

*MAX SPEED*

**NOTE:** The DRO limits the spindle speed to the top speed entered during DAC Output Voltage Setup (**F 96**). **MAX SPEED** is used if the part requires a lower maximum spindle speed than the preset top speed for the selected gear. When you select a new gear, the DRO uses the corresponding top speed as the default **MAX SPEED**.



## CSS/Direct RPM Input (450L With CSS and I/O Options) – F 48 (Continued)

To limit the spindle speed (For example, to **2500 RPM**):

4. Press     

**NOTE:** The decimal point at the left of the X-axis display will blink if the spindle speed is limited by MAX SPEED.

The DRO displays one of the following in the message window:

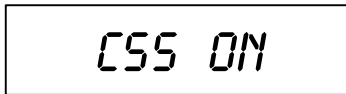

The available selections are:

- CSS ON**      Activates the CSS feature. The DRO varies the spindle speed to maintain a constant surface speed as the workpiece diameter changes.
- DIRECT RPM**      The DRO maintains the spindle speed at a constant RPM.

5. Press  

to toggle between the settings and to set the feature.

**NOTE:** If you select **DIRECT RPM**, skip to the **DIRECT RPM** section. If you select **CSS ON**, continue with the **CSS ON** section below.

### CSS ON

If you selected **CSS ON**, the DRO displays the following in the message window:

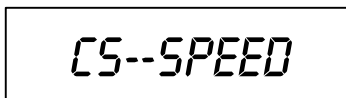

## CSS/Direct RPM Input (450L With CSS and I/O Options) – F 48 (Continued)

The X-axis display indicates the previously used surface speed. The X designation is blinking, indicating you can enter a value.

If the displayed surface speed is acceptable:

6. Press  to continue.
- OR**

To set a new surface speed (For example, **200** RPM):

7. Press    

**NOTE:** Surface speed must be entered in Feet per Minute when the DRO is set to **INCH** Mode or Meters per Minute when the DRO is set to **MM** Mode.

### DIRECT RPM

If you selected **DIRECT RPM**, the DRO displays the following in the message window:

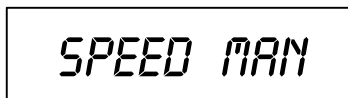

*SPEED MAN*

prompting for the desired spindle speed.

To set the spindle speed (For example, **2500** RPM):

6. Press     

## CSS/Direct RPM Input (450L With CSS and I/O Options) – F 48 (Continued)

If the displayed surface speed is acceptable:

7. Press  to continue.
- OR

To set a new surface speed (For example, **200** RPM):

8. Press     to set the surface speed.

**NOTE:** Surface speed must be entered in Feet per Minute when the DRO is set to **INCH** Mode or Meters per Minute when the DRO is set to **MM** Mode.

If you selected **DIRECT RPM**, the DRO displays the following in the message window:

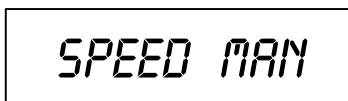

*SPEED MAN*

prompting for the desired spindle speed.

To set the spindle speed (For example, **2500** RPM):

9. Press      to set the spindle speed.

## DAC Output Voltage ON/OFF (450L With CSS and I/O Options) – F 50

F 50 allows you to turn the DAC output voltage ON or OFF:

To turn the DAC output voltage **ON** or **OFF**:

1. Press   

The DRO displays one of the following in the message window:

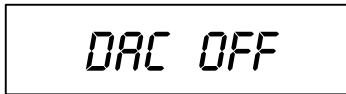

*DAC OFF*

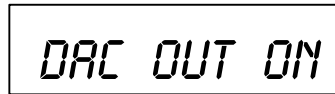

*DAC OUT ON*

2. Press  

to turn the DAC output  
voltage **ON** or **OFF**.

**NOTE:** Do not turn the spindle **ON** or **OFF** using **F 50**. The machine should have a separate switch for this purpose.

# Troubleshooting

This section lists problems that could arise with the DRO, and provides possible solutions to correct these problems.

Symptom	Solution
<ul style="list-style-type: none"><li>❑ Axis display does not illuminate.</li></ul>	<ol style="list-style-type: none"><li>1. Check that the power cord is properly connected and the DRO is turned on.</li><li>2. Check the AC voltage.</li><li>3. If all of the above are checked and OK, contact your local distributor or ANILAM Customer Services.</li></ol>
<ul style="list-style-type: none"><li>❑ When you move any axis, the displays do not update.</li></ul>	<ol style="list-style-type: none"><li>1. Check that the linear encoders are properly connected.</li><li>2. Run the system diagnostic tests (<b>F 45</b>).</li><li>3. If the DRO fails the diagnostics tests, contact your local distributor or ANILAM Customer Services.</li><li>4. If the DRO passes the diagnostics tests, turn on Linear Encoder Error Check (<b>F 41</b>).</li><li>5. Move the axis that is not updating.</li><li>6. If the DRO displays <b>ERROR</b> in the axis display, contact your local distributor or ANILAM Customer Services.</li></ol>
<ul style="list-style-type: none"><li>❑ When you press a key, the beeper does not sound.</li></ul>	<ol style="list-style-type: none"><li>1. Verify that the Beeper (<b>F 21</b>) is enabled.</li><li>2. If the Beeper is enabled, but still does not sound, contact your local distributor or ANILAM Customer Services.</li></ol>

## Troubleshooting (Continued)

### Symptom

- ❑ When the power is turned OFF, information in memory is lost.
- ❑ The DRO does not retain the set parameters as they were entered.
- ❑ Information recalled is incorrect.
- ❑ The DRO does not respond when you press a key or several keys.

### Solution

1. Contact your local distributor or ANILAM Customer Services.

# Index

100-point axis error compensation  
– F 80/F 81, 24, 39

## A

ABS/INCR key, 16  
absolute zero set, 23  
absolute zero set at reference  
mark – F 90, 24  
absolute/incremental key, 16  
ABSolute/INCRemental key, 2  
AC voltage, 143  
AC voltage fuse cover window, 3  
acknowledging a keystroke, 11  
adding values, 15  
adding/subtracting values, 31  
ADVanced functions key, 2, 78  
approaching zero, 50  
approaching zero – F 06, 49  
approaching zero audio  
on/off – F 08, 53  
approaching zero indicator, 48  
approaching zero output axis  
select – F 14, 119  
approaching zero range – F 07,  
51  
APZ OUT, 131  
APZ output, specify axis, 119  
at zero, 50  
audible keyboard tone, 5  
avoiding, electrical shock, 54  
axis  
coupling – F 18, 115  
designation – F 24, 73  
displays, 2  
error compensation, ON/OFF, 46  
keys, 2

reset only – F 16, 21  
to measure, 39

## B

back panel, Wizard 450, 3  
baud rate, 122, 127  
beeper, 75, 143  
beeper OFF/ON – F 21, 11  
blank test, 77  
bolt-hole pattern, 78, 80  
BT or JB linear encoders, 67

## C

cables, 6  
calculating the taper on a  
workpiece, 101  
centering key, 2, 33  
CF feature, 37  
CF indicator, 38  
changing  
the direction of travel in  
parameter setting, 15  
the sign of a preset value, 15  
checklist, first-time user, 5  
clear  
a preset dimension, 19  
correction factor from memory,  
47  
datum – F 31, 109  
tool offset – F 32, 114  
coarse resolution symbol, 64, 65,  
69, 70  
coincidence pulse output time  
options, 129  
compensation table  
key functions, description, 44  
selecting, 41, 44  
to delete, 45  
computer output, 122

# Index

connecting, the probe, 54  
connections, linear encoders,  
    ground, power cord, 3  
console display, 4  
constant surface speed (CSS),  
    138  
constant surface speed, setup,  
    132  
convert, inch values to metric  
    values, 13  
correct keystrokes, 11  
correction factor, 37  
correction factor indicator, 38  
correction factor off/on – F 04, 47  
counters test, 76  
CSS, constant surface speed,  
    138  
CSS ON, 139  
CSS option, 132  
Czech, 74

## D

DA 15 connector (male), 116  
DAC output  
    voltage, 142  
    voltage offset adjustment – F 97,  
    135  
    voltage setup – F 96, 133  
    voltage test – F 98, 136  
data  
    bit options, 123  
    bit settings, 127  
    bits, 122  
datum, 20  
datum key, 2, 103  
datum, clear – F 31, 109  
DE 9 connector (female), 121  
DE 9 connector (male), 117

decimal degree to degree-  
    minutes-seconds conversion,  
    14  
default rotary encoder line count,  
    68  
default settings, 5  
delete, compensation table, 45  
diagnostics – F 45, 76  
diameter mode, 35  
dim mode, 72  
direct RPM, 138  
DIRECT RPM, 139  
direction, of count, 5  
direction, of travel, 50  
disclaimer, iii  
display  
    console, illustration, 4  
    dim OFF/ON – F 22/F 23, 72  
    dimming, 5  
    languages, 74  
    resolution, 5, 60  
    test, 76  
    windows, 2  
dividing an axis value by 2, 32  
dividing values, 32  
DRO arm, 6

## E

earth ground, 6, 54  
edge sensor  
    connection, 3  
    indicator, 56  
    probe – F 09, 55  
EEProm test, 76  
encoder resolution, 60, 63  
English, 74  
ENTER key, 2



# Index

entering  
  a datum, 103  
  datum, alternate method, 106  
error-checking circuitry, 75  
establishing part zero, 20  
EverTrack™ mode – F 02, 25

## F

F 01, 23  
F 02, 25  
F 03, 37  
F 04, 47  
F 05, 35  
F 06, 49  
F 07, 51  
F 08, 53  
F 09, 55  
F 10, 30  
F 11, 30  
F 14, 119  
F 16, 21  
F 18, 115  
F 20, 60  
F 21, 11  
F 22, 72  
F 24, 73  
F 25, 120  
F 26, 57  
F 27, 122  
F 28, 125  
F 31, 109  
F 32, 114  
F 33, 118  
F 34, 58  
F 35, 113  
F 38, 128  
F 39, 128  
F 40, 75  
F 41, 75

F 42, 131  
F 45, 76  
F 48, 138  
F 50, 142  
F 80, 24, 39  
F 81, 24, 39, 46  
F 90, 24  
F 96, 132, 133  
F 97, 132, 135  
F 98, 132, 136  
F 99, 74  
factory settings, 5  
feedrate on/off – F 26, 57  
frame-hole pattern, 93, 94  
frame-hole/linear-hole patterns,  
  78  
French, 74  
full bolt-hole pattern, 80, 81, 86  
function code list, 8  
function key, 2

## G

German, 74  
ground, 6  
ground, connection, 3  
ground wire, 54

## H

help, 78

## I

I/O inputs, connection, 3  
I/O outputs, connection, 3  
inch linear encoders, 67  
inch values to metric values,  
  convert, 13  
inch/metric conversion, 13  
inch-based linear encoders, 60

# Index

incremental moves, 16  
input connections, 117  
input voltage switch, 6  
internal counters, 76  
internal EEPROM, 76  
introducing, the Wizard, 1  
Italian, 74

## J

job clock ON/OFF – F 34, 58

## K

key functions for compensation  
table, 44  
keyboard, 76  
keyboard entry error, 12  
keyboard test, 77  
keypad, 2

## L

language selection, 74  
last position save/recall –  
F 10/F 11, 30  
line count, 68  
linear encoder  
absolute reference marks, 25  
connections, illustration, 3  
error check, 143  
error detect OFF/ON –  
F 40/F 41, 75  
miscounts, 75  
resolution, 5  
setting, 66  
linear inaccuracies, 37  
linear-hole pattern, 93  
linear-hole/frame-hole patterns,  
78

## M

making, incremental moves, 20  
making, multiple moves of the  
same dimension, 18  
manual format, 7  
material, shrinkage/expansion, 37  
maximum spindle speed, 138  
measure, the axis, 39  
message window, 2  
metric linear encoders, 60, 62  
mill/lathe operation, 5  
MM/INCH key, 2  
modify, tool offset – F 35, 113

## N

numeric keys, 2

## O

ON/OFF switch, 3  
one-line recall mode, 17  
output connections, 116  
output test – F 42, 131

## P

parameter settings – F 20, 25, 60  
parity, 122, 127  
parity options, 123  
part zero, 23  
partial bolt-hole pattern, 80, 82  
pin assignments  
DA 15 connector, 116  
DE 9 connector (male), 117  
plus/minus ( $\pm$ ) key, 2, 15  
Portuguese, 74  
position tolerance indicator, 5  
power cord, 143  
power cord, connection, 3  
power loss, 18

# Index

preset values, 5  
presetting a dimension, 17  
printer output, 122  
printer/computer output options,  
124  
printing axis values, 126  
probe cable, 54

## Q

quick positioning, 21

## R

radius mode, 35  
radius/diameter  
mode, 5  
mode indicator, 35  
per axis – F 05, 35  
RBM-T linear encoders, 25  
RBS-T linear encoders, 25  
RCL key, 90  
recall  
a dimension, 18  
datum, 108  
key, 90  
last position, 30  
tool offset, 112  
ReCaLI key, 2  
recalling  
a bolt-hole pattern, 90  
a linear-hole pattern, 98  
a part zero position, 28  
a preset dimension, 18  
reference indicator (RI), 25  
referenced display, mode, 39  
relay 1, 116  
RELAY 1, 131  
relay 1 setup – F 38, 128  
relay 2, 116  
RELAY 2, 131

relay 2 setup – F 39, 128  
remote operation, 127  
resetting, absolute zero, 18  
resetting, an axis to zero, 20  
rotary encoders, 60, 68  
round spring clip, 54  
RS-232

connection, 3  
interface, 127  
interface connector, pin  
assignments, 121  
ON/OFF – F 28, 125  
setup – F 27, 122  
RST symbol, 21, 22

## S

scrolling, 15  
select language – F 99, 74  
SET Key, 2  
setting  
a correction factor – F 03, 37  
a part zero - all axes, 26  
up encoder parameters, 60, 62  
Spanish, 74  
spindle speed, 134  
subtracting values, 15  
Swedish, 74  
system diagnostic tests, 76, 143

## T

taper calculation, 78  
taper calculator, 101  
temporary datum while in  
EverTrack™ Mode, 26  
tool offset  
clear – F 32, 114  
key, 2, 110  
modify – F 35, 113  
troubleshooting, 143

# Index

turning the machine OFF, 30

## W

warranty, iii

Wizard 450 DRO, 1, 2

Wizard 450L DRO, 1, 2

## X

X ZERO OUT, 131

## Y

Y ZERO OUT, 131

## Z

Z ZERO OUT, 131

Zero Output – F 33, 120

zero output

ON/OFF – F 33, 118, 120

time select – F 25, 120

time settings, listed, 120

# ANILAM

## U.S.A.

ANILAM  
One Precision Way  
Jamestown, NY 14701  
☎ (716) 661-1899  
☎ (716) 661-1884  
✉ anilaminc@anilam.com

## ANILAM, CA

16312 Garfield Ave., Unit B  
Paramount, CA 90723  
☎ (562) 408-3334  
☎ (562) 634-5459  
✉ anilamla@anilam.com

**Dial "011" before each number  
when calling from the U.S.A.**

## China

Acu-Rite Companies Inc.  
(Shanghai Representative Office)  
Room 1986, Tower B  
City Center of Shanghai  
No. 100 Zunyi Lu Road  
Chang Ning District  
200051 Shanghai P.R.C.  
☎ +86 21 62370398  
☎ +86 21 62372320  
✉ china@anilam.com

## France

ANILAM S.A.R.L.  
2 Ave de la Cristallerie  
B.P. 68-92316  
Sevres Cedex, France  
☎ +33-1-46290061  
☎ +33-1-45072402  
✉ courrier@acu-rite.fr

P/N 70000422B  
6-February-04

## Germany

ANILAM GmbH  
Fraunhoferstrasse 1  
D-83301 Traunreut  
Germany  
☎ +49 8669 856110  
☎ +49 8669 850930  
✉ info@anilam.de

## Italy

ANILAM Elettronica s.r.l.  
10043 Orbassano  
Strada Borgaretto 38  
Torino, Italy  
☎ +39 011 900 2606  
☎ +39 011 900 2466  
✉ info@anilam.it

## Taiwan

ANILAM, TW  
No. 246 Chau-Fu Road  
Taichung City 407  
Taiwan, ROC  
☎ +886-4 225 87222  
☎ +886-4 225 87260  
✉ anilamtw@anilam.com

## United Kingdom

ACI (UK) Limited  
16 Plover Close, Interchange Park  
Newport Pagnell  
Buckinghamshire, MK16 9PS  
England  
☎ +44 (0) 1908 514 500  
☎ +44 (0) 1908 610 111  
✉ sales@aciuk.co.uk

www.anilam.com