

ANILAM

Wizard 900/900E Digital Readout Operations Manual

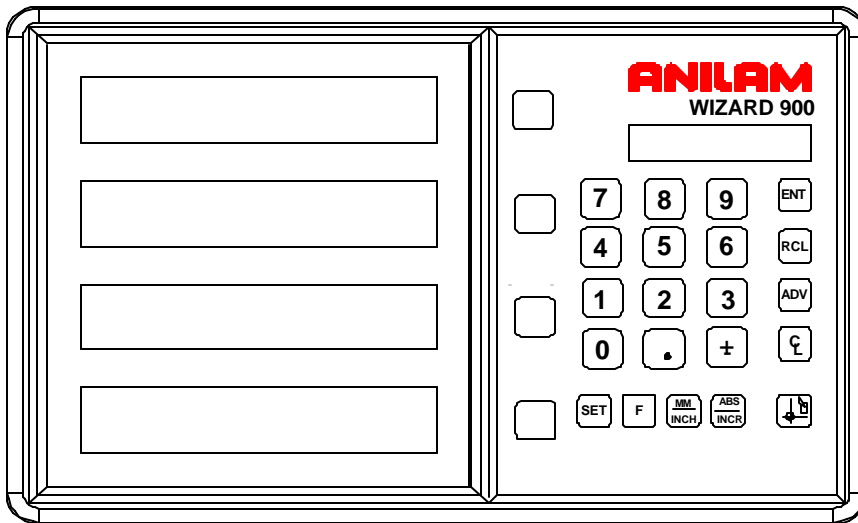

SALES & SERVICE:
A Tech Authority, Inc.

13745 Stockton Ave.
Chino CA 91710

909-614-4522

sales@atechauthority.com

P/N 70000423B

Warranty

Anilam warrants its products to be free from defects in material and workmanship for three (3) years from date of installation. At our option, we will repair or replace any defective product upon prepaid return to our factory.

This warranty applies to all products when used in a normal industrial environment. Any unauthorized tampering, misuse, or neglect will make this warranty null and void.

Under no circumstances will Anilam, any affiliate, or related company assume any liability for loss of use or for any direct or consequential damages.

The foregoing warranties are in lieu of all other warranties expressed or implied, including, but not limited to, the implied warranties of merchantability and fitness for a particular purpose.

System Purchased From: _____

Console Part Number: _____

Console Serial Number: _____

Date of Installation: _____

Feature, Operation, and Technology

WIZARD Digital Readouts provide the absolute latest in ease of operation, capability, and technology. As a result, Anilam Inc. may alter and enhance operation, features, and capabilities without notice.

© Copyright 2004 ACU-RITE Companies, Inc.

Contents

| | |
|---|----|
| Contents | v |
| Introducing the Wizard..... | 1 |
| The ANILAM Wizard 450/450L Keypad and Display Windows | 2 |
| The ANILAM Wizard 450/450L Back Panel..... | 3 |
| First-Time User Checklist | 5 |
| About This Manual..... | 7 |
| Function Code List..... | 8 |
| Beeper OFF/ON – F 21 | 11 |
| Keyboard Entry Error | 12 |
| Inch/Metric Conversion | 13 |
| Decimal Degree to Degree-Minutes-Seconds Conversion..... | 14 |
| Plus/Minus (\pm) Key..... | 15 |
| Absolute/Incremental (ABS/INCR) Key | 16 |
| Presetting a Dimension | 17 |
| Recalling a Preset Dimension | 18 |
| Clearing a Preset Dimension..... | 19 |
| Resetting an Axis to Zero | 20 |
| Axis Reset Only – F 16 | 21 |
| Absolute Zero Set – F 01..... | 23 |
| Absolute Zero Set at Reference Mark – F 90 | 24 |
| EverTrack™ Mode – F 02..... | 25 |
| Last Position Save/Recall – F 10/F 11 | 30 |
| Adding/Subtracting Values | 31 |
| Dividing an Axis Value by 2 | 32 |
| Centering Key | 33 |
| Radius/Diameter per Axis – F 05..... | 35 |
| Setting a Correction Factor – F 03 | 37 |
| 100-Point Axis Error Compensation – F 80/F 81..... | 39 |
| Measure the Axis | 39 |

Contents (Continued)

| | |
|---|----|
| Selecting the Compensation Table, Entering an Axis Compensation | 41 |
| Key Functions for Compensation Table..... | 44 |
| Deleting a Compensation Value Table | 45 |
| Axis Error Compensation ON/OFF | 46 |
| Correction Factor OFF/ON – F 04 | 47 |
| Approaching Zero Indicator | 48 |
| Approaching Zero – F 06..... | 49 |
| Approaching Zero Range – F 07 | 51 |
| Approaching Zero Audio ON/OFF – F 08..... | 53 |
| Connecting the Edge Sensor Probe..... | 54 |
| Edge Sensor Probe – F 09..... | 55 |
| Feedrate ON/OFF – F 26 | 57 |
| Job Clock ON/OFF – F 34 | 58 |
| Parameter Settings – F 20..... | 60 |
| Setting Up Encoder Parameters..... | 60 |
| Metric Linear Encoders..... | 62 |
| Inch Linear Encoders (BT or JB Linear Encoders)..... | 67 |
| Rotary Encoders..... | 68 |
| Display Dim OFF/ON – F 22/ F 23 | 72 |
| Axis Designation – F 24..... | 73 |
| Select Language – F 99 | 74 |
| Linear Encoder Error Detect OFF/ON – F 40/F 41..... | 75 |
| Diagnostics – F 45..... | 76 |
| Advanced (ADV) Functions Key..... | 78 |
| Help Function..... | 78 |
| Bolt-Hole Pattern Function (450 Only)..... | 80 |
| Partial Bolt-Hole Pattern | 82 |
| Full Bolt-Hole Pattern (450 Only)..... | 86 |
| Recalling Bolt-Hole Pattern Function (450 Only)..... | 90 |

Contents (Continued)

| | |
|--|-----|
| Linear-Hole/Frame-Hole Pattern Function (450 Only)..... | 93 |
| Recalling Linear-Hole/Frame-Hole Function (450 Only)..... | 98 |
| Taper Calculator Function (450L Only)..... | 101 |
| Datum Key (450 Only)..... | 103 |
| Enter Datum..... | 103 |
| Enter Datum (Alternate Method)..... | 106 |
| Recall Datum..... | 108 |
| Clear Datum – F 31..... | 109 |
| Tool Offset Key (450L Only)..... | 110 |
| Enter Tool Offset..... | 110 |
| Recall Tool Offset..... | 112 |
| Modify Tool Offset – F 35..... | 113 |
| Clear Tool Offset – F 32..... | 114 |
| Axis Coupling (450L, 3-Axis Only) - F 18..... | 115 |
| Output Connections (With I/O Option Only)..... | 116 |
| Input Connections (With I/O Option Only)..... | 117 |
| Zero Output ON/OFF (With I/O Option Only) – F 33..... | 118 |
| Approaching Zero Output Axis (With I/O Option Only) – F 14..... | 119 |
| Zero Output Time Select (With I/O Option Only) – F 25..... | 120 |
| RS-232 Interface (With I/O Option Only)..... | 121 |
| RS-232 Setup (With I/O Option Only) – F 27..... | 122 |
| RS-232 ON/OFF (With I/O Option Only) – F 28..... | 125 |
| Printing Axis Values (With I/O Option Only)..... | 126 |
| Remote Operation (With I/O Option Only)..... | 127 |
| Relay 1/Relay 2 Setup (With I/O Option Only) – F 38/F 39..... | 128 |
| Output Test (With I/O Option Only) – F 42..... | 131 |
| Constant Surface Speed (CSS) Setup (450L With CSS and I/O Options)..... | 132 |
| DAC Output Voltage Setup (450L With CSS and I/O Options) – F 96..... | 133 |
| DAC Output Voltage Offset Adjustment (450L With CSS and I/O Options) – F 97..... | 135 |

Contents (Continued)

| | |
|---|---------|
| DAC Output Voltage Test (450L With CSS and I/O Options) – F 98 | 136 |
| Constant Surface Speed (CSS)/Direct RPM Operation (450L With CSS and I/O Options) | 137 |
| CSS/Direct RPM Input (450L With CSS and I/O Options) – F 48 | 138 |
| DAC Output Voltage ON/OFF (450L With CSS and I/O Options) – F 50 | 142 |
| Troubleshooting | 143 |
| Index-1 | Index-1 |

Introducing the Wizard

Thank you for purchasing the ANILAM Wizard 900/900E Digital Readout (DRO).

Review these pages carefully to learn how to properly operate your new DRO.

The new DRO offers many features and capabilities never before used in conventional DRO systems. Two models are available: the standard **Wizard 900 DRO** and the special EDM version **Wizard 900E DRO**. The 900E includes EDM features such as three Z-axis EDM Mode during the spark cycle, spark out, and ****SparkArrest™**, a useful safety feature.

The following three options are available with the 900 DRO.

- Input/Output Module (I/O) Includes a DA 15 output connector, a DE 9 input connector, and a DE 9 connector for RS-232 serial communication.
- Constant Surface Speed (CSS) Allows you to control the spindle speed to maintain a constant surface speed independent of diameter.
- Spindle Speed Display (SSD) Allows you to display the spindle speed (rotary encoder required).

The 900E provides the Input/Output Module option as standard.

This manual was written with you, the operator, in mind. Please take the time to study it. A little well-spent time now will ensure many years of trouble-free operation.

For additional information, contact your local authorized ANILAM distributor, or call us directly:

ANILAM, Inc.
One Precision Way
Jamestown, New York, U.S.A., 14701
Phone: (716) 661-1700
FAX: (716) 661-1884
E-mail: anilaminc@anilam.com
www.anilam.com

****SparkArrest™** SparkArrest™ is a trademark of ACU-RITE Companies, Inc.

Introducing the Wizard (Continued)

The ANILAM Wizard 900/900E Keypad and Display Windows

NOTE: The Wizard 900 DRO is available in 2-axis, 3-axis, and 4-axis models; the Wizard 900E DRO is available only in 3-axis models. For simplicity, most of the procedures in this manual describe a 3-axis model.

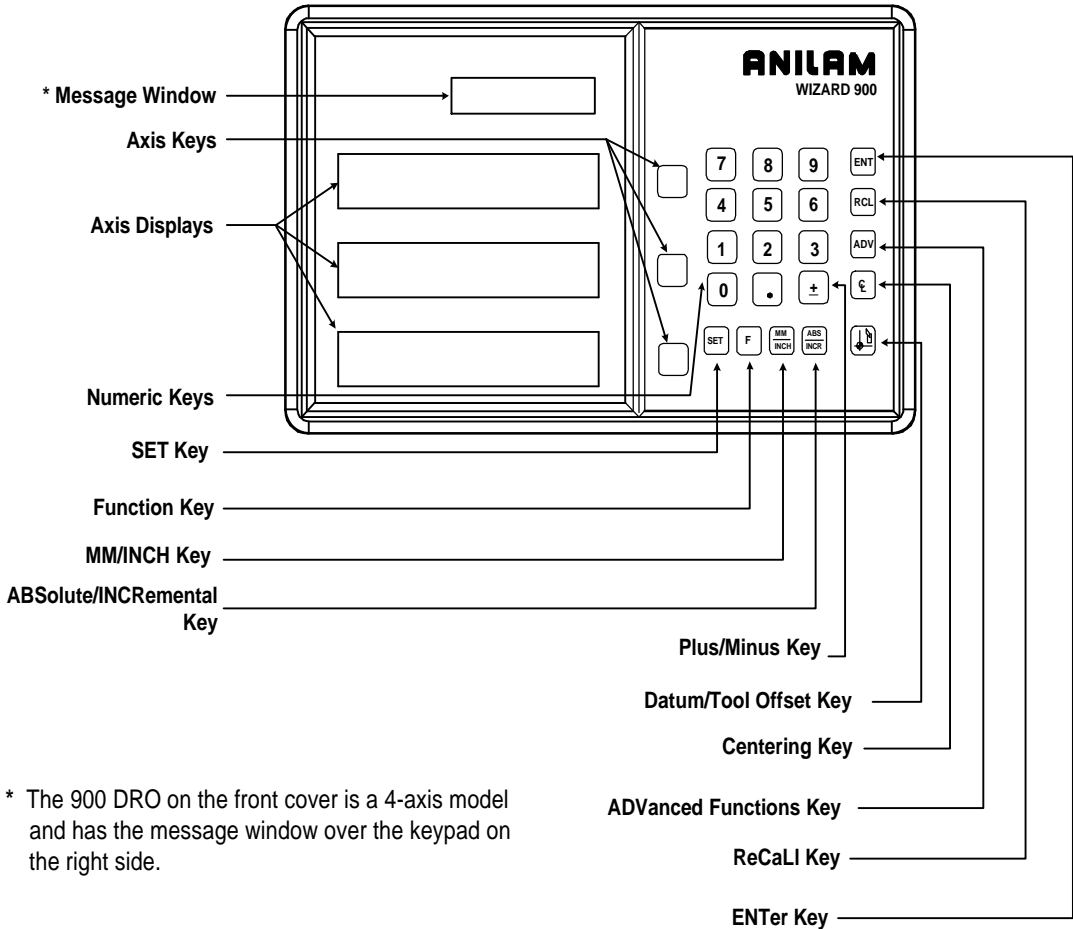

* The 900 DRO on the front cover is a 4-axis model and has the message window over the keypad on the right side.

Introducing the Wizard (Continued)

The ANILAM Wizard 900/900E Back Panel

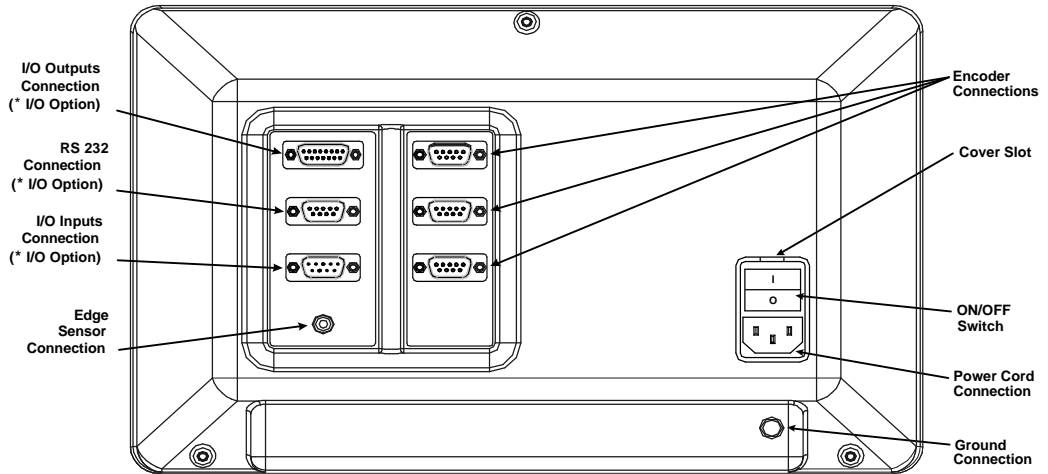

* I/O Option is standard on 900E.

Introducing the Wizard (Continued)

Your Wizard's display was designed to be easy to read:

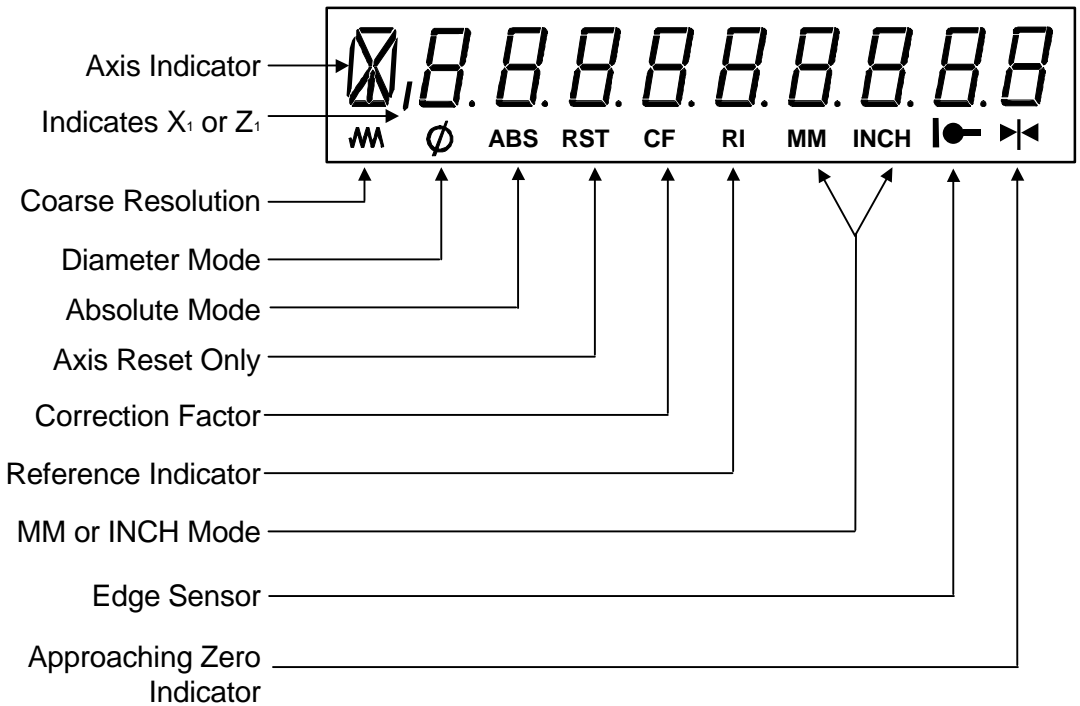

First-Time User Checklist

Your new DRO has many preset values. Before you proceed, please review the following list to verify default settings. If you need to change any setting(s), refer to [Parameter Settings – F 20](#).

| Description of Setting | | Factory Setting | | | Your Setting |
|---------------------------------|--|-----------------|-----------------------|----------|--------------|
| | | 900 DRO | | 900E DRO | |
| 1. Mill/Lathe/EDM Operation | | MILL | LATHE | EDM | |
| 2. Linear Encoder Resolution | | Axis 1 | 5 µm | | |
| | | Axis 2 | 5 µm | | |
| | | Axis 3 | 5 µm | | |
| | | Axis 4 | 5 µm | | |
| 3. Direction of Count | | Axis 1 | + | | |
| | | Axis 2 | + | | |
| | | Axis 3 | + | | |
| | | Axis 4 | + | | |
| 4. Position Tolerance Indicator | | Axis 1 | Set to Zero | | |
| | | Axis 2 | Set to Zero | | |
| | | Axis 3 | Set to Zero | | |
| | | Axis 4 | Set to Zero | | |
| 5. Audible Keyboard Tone | | ON | | | |
| 6. Display Resolution | | Axis 1 | .0002 inches (.005mm) | | |
| | | Axis 2 | .0002 inches (.005mm) | | |
| | | Axis 3 | .0002 inches (.005mm) | | |
| | | Axis 4 | .0002 inches (.005mm) | | |
| 7. Display Dimming | | 15 Minutes | | | |
| 8. Radius/Diameter Mode | | Axis 1 | Radius | Diameter | Radius |
| | | Axis 2 | Radius | Diameter | Radius |
| | | Axis 3 | Radius | Diameter | Radius |
| | | Axis 4 | Radius | Diameter | Radius |

First-Time User Checklist (Continued)

For your safety, and to prevent damage to the machine, please verify the following:

| | |
|---|--------|
| 9. DRO arm and DRO are securely mounted to the machine. | Yes/No |
| 10. The DRO Input-voltage switch on the power-entry module (back panel) is set to the correct input voltage. | Yes/No |
| 11. DRO is properly grounded. (Earth ground to wall conduit or water pipe, for example, not grounded to the machine). | Yes/No |
| 12. All cables are off the floor and out of the range of moving parts. | Yes/No |

About This Manual

This manual contains limited text and enlarged graphics for easy use. Actual keystrokes are represented by graphics.

The format is as follows:

Function Heading

Function Description

Example with Keystrokes

Explanation of Procedures and Observations

NOTE: Indicates you must use caution.

Function Code List

You can access most DRO features using function codes. Function codes are codes entered by pressing the Function key (F) and then pressing the two-digit code for the feature. The following table lists the function codes available with your DRO. The page number indicates where the function is described in this manual.

| Code | Description | Page |
|----------------------|--|------|
| F 01 | Absolute Zero Set | 23 |
| F 02 | EverTrack™ Mode | 25 |
| F 03 | Setting a Correction Factor | 37 |
| F 04 | Correction Factor OFF/ ON | 47 |
| F 05 | Radius/Diameter per Axis | 35 |
| F 06 | Approaching Zero | 49 |
| F 07 | Approaching Zero Range | 51 |
| F 08 | Approaching Zero Audio ON/OFF | 53 |
| F 09 | Edge Sensor Probe | 55 |
| F 10 | Last Position Save | 30 |
| F 11 | Last Position Recall | 30 |
| F 14 | Approaching Zero Output Axis Select (900 With I/O Option Only) | 140 |
| F 16 | Axis Reset Only | 21 |
| F 17 | Mirror Image | 135 |
| F 18 | Axis Coupling (900, 3-/4-Axis Only) | 120 |
| F 19 | Axis Coupling (900, 4-Axis Only) | 120 |
| F 20 | Parameter Settings | 60 |
| F 21 | Beeper OFF/ ON | 11 |
| F 22 | Display Dim OFF | 71 |
| F 23 | Display Dim ON | 71 |

Function Code List (Continued)

| | | |
|----------------------|--|-----|
| F 24 | Axis Designation | 72 |
| F 25 | Zero Output Time Select (With I/O Option Only) | 141 |
| F 26 | Feedrate ON/OFF | 57 |
| F 27 | RS-232 Setup (With I/O Option Only) | 143 |
| F 28 | RS-232 ON/OFF (With I/O Option Only) | 146 |
| F 29 | Mill/Lathe Setup (900 Only) | 77 |
| F 31 | Clear Datum (N/A For 900, Lathe Mode) | 114 |
| F 32 | Clear Tool Offset (900, Lathe Mode Only) | 119 |
| F 33 | Zero Output ON/OFF (With I/O Option Only) | 139 |
| F 34 | Job Clock ON/OFF | 58 |
| F 35 | Modify Tool Offset (900, Lathe Mode Only) | 118 |
| F 37 | Entering Target Z-Depth and Spark-Out Time (900E Only) | 181 |
| F 38 | Relay 1 Setup (900 With I/O Option Only) | 152 |
| | Z-Depth Guard Setup, Relay 1 (900E Only) | 177 |
| F 39 | Relay 2 Setup (900 With I/O Option Only) | 152 |
| | Spark-Out/SparkArrest™ Setup, Relay 2 (900E Only) | 179 |
| F 40 | Linear Encoder Error Detect OFF | 74 |
| F 41 | Linear Encoder Error Detect ON | 74 |
| F 42 | Output Test (With I/O Option Only) | 155 |
| F 45 | Diagnostics | 75 |
| F 46 | First Spark Detection Setup (900 With CSS and I/O Options) | 171 |
| F 48 | CSS/Direct RPM Input (900 With CSS and I/O Options) | 161 |
| F 50 | DAC Output Voltage ON/OFF (900 With CSS and I/O Options) | 164 |

Function Code List (Continued)

| | | |
|----------------------|---|-----|
| F 60 | Send Program to External Device (With I/O Option Only) | 149 |
| F 61 | Recall Program from External Device (With I/O Option Only) | 150 |
| F 62 | Print Program to External Printer (With I/O Option Only) | 151 |
| F 63 | Select Axis for Recall | 134 |
| F 80 | 100-Point Axis Error Compensation | 39 |
| F 81 | 100-Point Axis Error Compensation – Exit | 46 |
| F 90 | Absolute Zero Set at Reference Mark | 24 |
| F 96 | DAC Output Voltage Setup (900 With CSS and I/O Options) | 157 |
| F 97 | DAC Output Voltage Offset Adjustment (900 With CSS and I/O Options) | 158 |
| F 98 | DAC Output Voltage Test (900 With CSS and I/O Options) | 159 |
| F 99 | Select Language | 73 |
| | | |

Beeper OFF/ON – F 21

The beeper is a standard feature on all ANILAM DROs. Use the beeper to acknowledge a keystroke. For correct keystrokes, a short tone sounds. For incorrect keystrokes, a long tone sounds.

F 21 allows you to enable/disable the beeper in the DRO (Default: ON).

To turn the beeper OFF:

1. Press   

The DRO displays the following in the message window:

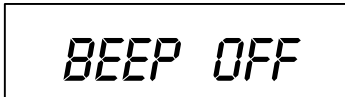

BEEP OFF

To turn the beeper ON:

1. Press   

The DRO displays the following in the message window:



BEEP ON

Keyboard Entry Error

If you enter an incorrect value, press the axis key again to clear the axis display. If you enter too many numbers on an axis, the DRO display reverts to zero on that axis. When this happens, enter the correct number again.

Inch/Metric Conversion

This feature allows you to convert inch values to metric values and vice-versa on all axes.

Example: Change **1.000 in.** to its metric (**mm**) equivalent.

1. Press the desired axis key to select the axis.

2. Press

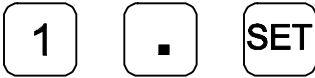

The DRO displays the following:



3. Press



The DRO displays the following:

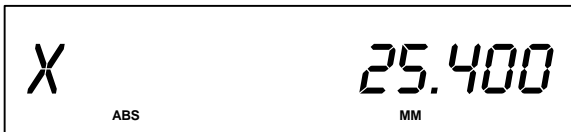

NOTE: The DRO displays the **INCH** or **MM** symbol under each axis display.

Decimal Degree to Degree-Minutes-Seconds Conversion

You can use every axis to display angular position when you connect a rotary encoder to the DRO. The display range is ± 360 degrees.

NOTE: The axis must be set to rotary using [Parameter Settings – F 20](#).

To convert all angular axis displays from decimal-degree display to degree-minutes-seconds display:

1. Press  

Plus/Minus (\pm) Key

The \pm key allows you to:

- ❑ Change the sign of a preset value.
- ❑ Change the direction of travel on a linear encoder while in parameter setting.
- ❑ Add and subtract values.
- ❑ Scroll through options lists while making selections.
- ❑ Scroll through the Advanced Functions (**ADV**) list.

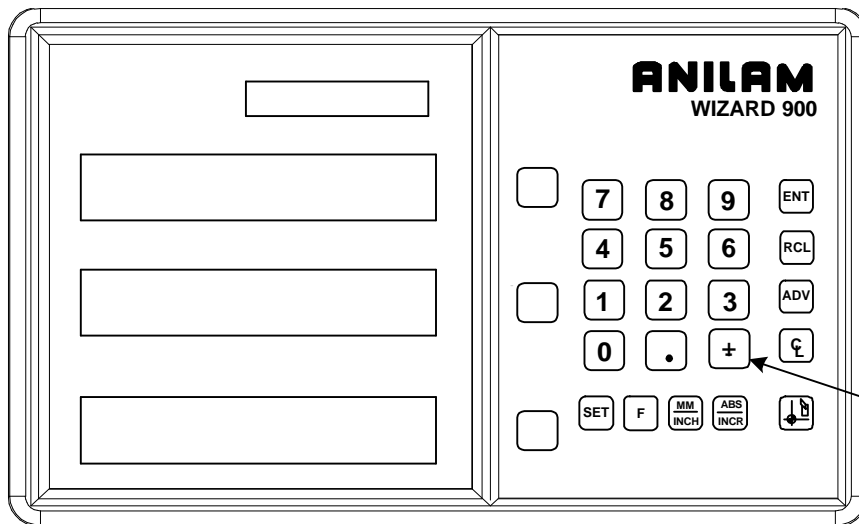

Plus/Minus Key

Absolute/Incremental (ABS/INCR) Key

When the Absolute Mode indicator is OFF, the DRO measures in increments and internally tracks the corresponding absolute (**ABS**) dimensions. This is a safeguard and serves to measure the total distance being moved along a given axis.

Press **ABS/INCR** to switch the display to Absolute Mode. The DRO displays the Absolute dimension from the starting point on the axis display.

Example: If a series of six **2.00 in. (50.8 mm)** incremental moves are made, change to **ABS Mode** to display the total distance moved, which is **12.000 in. (304.80 mm)**.

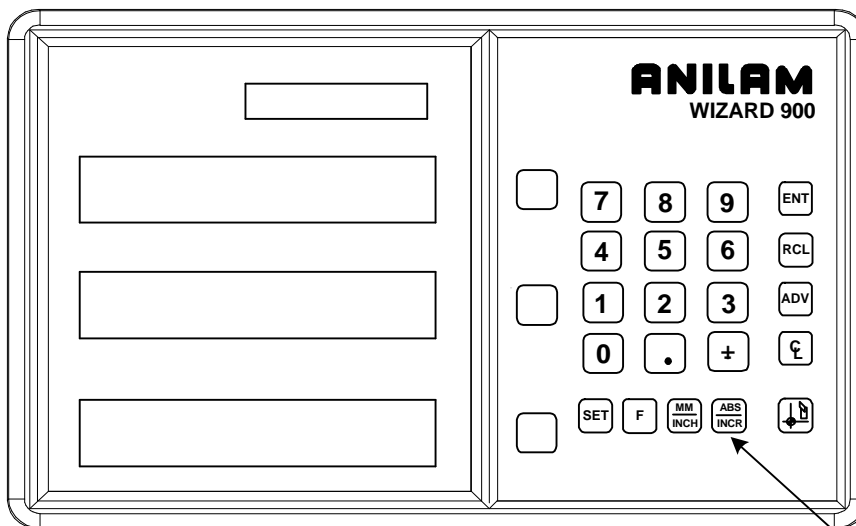

**Absolute/Incremental
Key**

Presetting a Dimension

Presetting allows you to enter a dimension into an axis display. After you have preset the dimension, you can move the machine until the axis indicates zero.

You can also use the preset feature as a one-line recall mode if the display is set in Incremental Mode.

Example 1: Preset the dimension **1.2500 (31.75 mm)** on the axis display.

1. Press the desired axis key.

2. Press     to enter the dimension.

3. Press  to preset the dimension.

Example 2: Preset the dimension **- 1.2500 in. (- 31.75 mm)** on one axis display and **.5000 (12.7 mm)** on another axis display.

1. Press the desired axis key.

2. Press      to enter the dimension.

3. Press the desired axis key.

4. Press   to enter the dimension.

5. Press  to preset the dimension.

NOTE: As a safety feature, the preset axis does not display movement until you press **SET**. If you press **SET** after you move the machine, the DRO automatically updates to the new position.

Recalling a Preset Dimension

This feature allows you to recall a preset dimension to the axis display.

Use this feature when making multiple moves of the same dimension.

NOTE: This feature works only in Incremental Mode.

To recall a preset dimension:

1. Press  to set the display to Incremental Mode.
2. Press the desired axis key(s) to select the axes.
3. Enter the incremental dimension.
4. Move the machine to zero.
5. Press the desired axis key twice to recall the dimension.

NOTE: You can recall a dimension after you reset absolute zero or when you have regained power after a power loss.

To clear a preset dimension while in Incremental Mode:

1. Press the desired axis key(s) to select the axes.
2. Press 

Clearing a Preset Dimension

When you clear a dimension, you automatically zero the previously entered dimension in an axis.

To clear preset dimensions, one axis at a time:

1. Press the desired axis key to select the axis.

2. Press



To clear entered dimensions for all axes:

1. Press the desired axis key(s) to select the axes.

2. Press



Resetting an Axis to Zero

When you reset an axis, the display for that axis reverts to zero

Use the reset feature when establishing part zero (datum) or clearing the axis at each part location (making incremental moves).

To reset one axis (X, Y, or Z):

1. Press the desired axis key to select the axis.

2. Press 

To reset two or more axes at the same time:

1. Press the desired axis key(s) to select the axes.



2. Press 

NOTE: See also [Absolute Zero Reset – F 01](#).

Axis Reset Only – F 16

F 16 is useful for quick positioning. Press the axis key once to zero the display in either **ABS** or **INCR** Mode.

Example 1: Set one axis as Axis Reset Only – for example, X-axis:

1. Press    to select the feature.

The DRO displays the following in the message window:



AXIS RESET

2. Press the desired axis key to toggle axis reset only ON (or OFF).

The DRO turns ON the **RST** symbol in the axis display:



X F 16
RST

3. Press  to set the feature.

4. Press the X-axis key to zero the axis display in either **ABS** or **INCR** Mode.

NOTE: Perform the same procedure to turn OFF Axis Reset Only.

Axis Reset Only – F 16 (Continued)

Example 2: Set two or more axes as Axis Reset Only – for example, X-axis and Y-axis:

1. Press    to select the feature.

The DRO displays the following in the message window:



AXIS RESET

2. Press the desired axis key to toggle Axis Reset Only ON (or OFF).

The DRO turns ON the **RST** symbol in the axis displays.

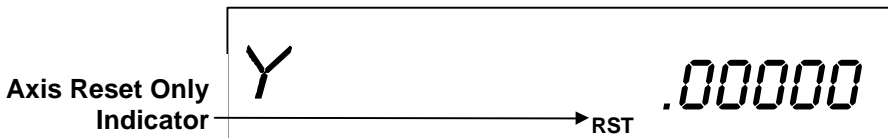
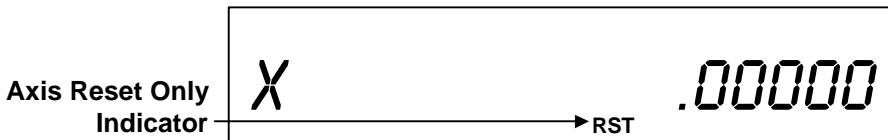

3. Press  to set the feature.
4. Press the X-axis key to zero the axis display in either **ABS** or **INCR** Mode.



NOTE: Perform the same procedure to turn OFF Axis Reset Only.

Absolute Zero Set – F 01

F 01 allows you to establish a part zero. The DRO clears all axis counters, both absolute and incremental, to zero.

NOTE: This feature does not clear a preset dimension entered in Incremental Mode. To clear a dimension entered in Incremental Mode; refer to [Recalling a Preset Dimension](#).

To reset all axes to zero:

1. Press   

The DRO temporarily displays the following in the message window:

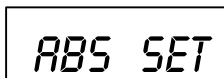

ABS SET

and then clears the axis displays.

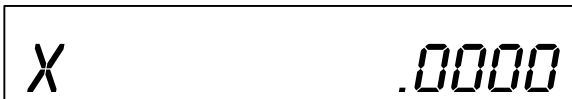

X .0000

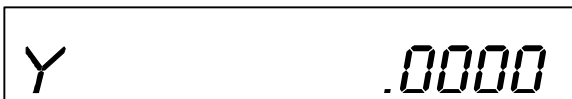



Y .0000

Absolute Zero Set at Reference Mark – F 90

F 90 allows you to reset one or more axes to zero at the reference mark. You must use this feature when you use 100-point axis error compensation (**F 80/F 81**).

To reset all axes at the reference mark:



1. Press   

The DRO resets all axis displays and displays the following in the message window:



MARKER

To reset one axis at the reference mark:

1. Press   
2. Press the desired axis key.

3. Press 

The DRO resets the specified axis display and displays the following in the message window:



MARKER

EverTrack™ Mode – F 02

F 02 allows you to permanently store a part zero position (machine home, tool-change position, or datum). This allows you to return to a specific location on a workpiece such as when power fails before the work is complete.

NOTE: This feature works **ONLY** with **RBS-T** and **RBM-T** linear encoders, which contain absolute reference marks. If your application uses linear encoders without absolute reference marks, disable EverTrack™ Mode (NO E-TRAC) using [Parameter Settings – F 20](#).

EverTrack™ Mode can be set either one axis at a time or all axes at a time. If you have a three-axis application but require fewer than three axes, we recommend that you set the part zero positions one axis at a time.

Setting a Part Zero - One Axis

To set up a part zero position for one axis:

1. Press    to select the feature.

The DRO displays the following in the message window:



EVERTRACK

2. Press the desired axis key.

3. Press .

The axis display resets to zero and the Reference Indicator (**RI**) begins to blink.

CAUTION: During the following step, do not change the machine axis travel direction. This will cause an error.

4. Move the machine axis approximately **1 in. (25.4 mm)** in one direction until the **RI** stops blinking and the display starts to count.

EverTrack™ Mode – F 02 (Continued)

5. Move the machine axis to the part zero position.



6. Press

This will be the absolute part zero position.

CAUTION: If you require a temporary datum while in EverTrack™ Mode, we recommend you exit the feature before you set the temporary datum.

To exit EverTrack™ Mode:



7. Press



8. Press

The DRO turns off the **RI** and stores the absolute part zero position. Now you can perform an absolute reset (Axis key + **SET** key) on an axis or an absolute reset (**F 01**).

Setting a Part Zero – All Axes

To set up a part zero position for all axes:



1. Press

to select the feature.

The DRO displays the following in the message window:



2. Press

The axis displays reset to zero and the **RI**s begin to blink for each axis.

EverTrack™ Mode – F 02 (Continued)

CAUTION: During the following step, do not change the machine axis travel direction. This will cause an error.

3. Move each machine axis approximately **1 in. (25.4 mm)** in one direction until the **RI**s stop blinking and the display starts to count.
4. Move each machine axis to the part zero position.

5. Press   

This will be the absolute part zero position.

To exit EverTrack™ Mode:

6. Press   

The DRO displays the following in the message window:



EVERTRACK

7. Press 

The **RI** turns off and the DRO stores the absolute part zero position.

8. Continue with normal operations.

EverTrack™ Mode – F 02 (Continued)

Recalling a Part Zero Position

To recall a part zero position activate the **RI** as follows:





One Axis

1. Press    to select the feature.
2. Press the desired axis key.

3. Press 

The axis display resets to zero and the **RI** begins to blink.

All Axes

1. Press    to select the feature.
2. Press  to select all axes.

The axis displays reset to zero and the **RI**s begin to blink for each axis.

CAUTION: During the following step, do not change the machine axis travel direction. This will cause an error.

3. Move the machine axis approximately **1 in. (25.4 mm)** in one direction until the display starts counting.

The value displayed on the axis display indicates the exact distance from the absolute part zero position.

4. Move the machine axis until the display indicates zero.

Zero indicates the exact absolute part zero position.

EverTrack™ Mode – F 02 (Continued)

To exit EverTrack™ Mode:

5. Press   

6. Press 



Last Position Save/Recall – F 10/F 11

F 10 allows you to save the machine's last position before turning OFF the machine; **F 11** allows you to recall the saved position after turning ON the machine.

NOTE: If you have **EverTrack™ Mode**, you can always recall all datum points, even if you move the table during power-off.

IMPORTANT: Lock all axes of machine movement first.

To select the feature and save the last position:

1. Press   

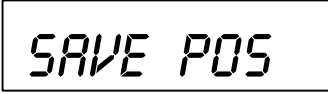

The DRO displays the following in the message window:



SAVE POS

2. Turn OFF the DRO power.

To recall the saved position:

1. Turn ON the DRO power.
2. Press   

to recall the last machine position.

The DRO displays the following in the message window:



RECALL POS

3. Unlock the machine and continue with the job.

NOTE: This feature stores display information only. It does not track table movement when power is turned OFF.

Adding/Subtracting Values

This feature allows you to add or subtract values using the axis display values. You can add/subtract a value to/from a value displayed for a machine position or for values you enter in an axis display.

Example 1: The axis display indicates **3.425 in. (87 mm)**. To add **1.259 in. (32 mm)** to this value:

1. Press the desired axis key to select the axis.

2. Press

The axis display now indicates **4.684 (119 mm)**.

Example 2: To subtract **1.259 in. (32 mm)** from **3.425 in. (87 mm)** in the axis display:

1. Press the desired axis key to select the axis.

2. Press

3. Press the desired axis key to select the axis.

4. Press

The axis display now indicates **2.166 in. (55 mm)**.

Dividing an Axis Value by 2

This feature allows you to divide a value on an axis display by 2. You can also divide any values entered in an axis display by 2.







Example 1: The axis display indicates **7.126 in. (181 mm)**. To divide this value by 2:

1. Press 
2. Press the desired axis key.

The axis display now indicates **3.563 in. (90.5 mm)**.

Example 2: To divide **1.260 in. (32 mm)** by 2 in the axis display:

1. Press the desired axis key.

2. Press      

3. Press 
4. Press the desired axis key.

The axis display now indicates **.630 in. (16 mm)**.

NOTE: You can use this feature to find the center point of a workpiece by zeroing the tool at one edge of the workpiece, then moving the tool to the opposite edge and dividing by 2.

Centering Key

The Centering Key allows you to center the tool on the centerline of the workpiece, or on a specific position on the workpiece.

Example: To center the tool on the centerline of the workpiece:

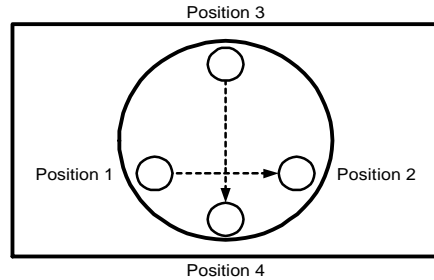
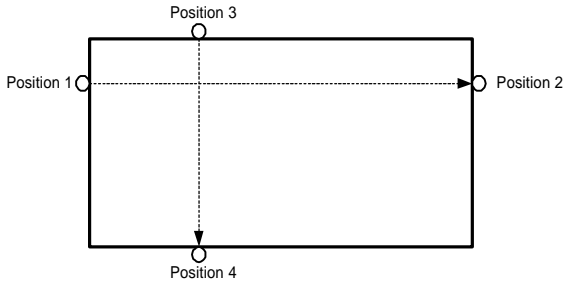

1. Press

to activate the feature.

The DRO displays the following in the message window:

A rectangular box representing the DRO display showing the text *EDGE X1* in a stylized, italicized font.

2. Move the tool to position 1.



3. Press

The DRO displays the following in the message window:

A rectangular box representing the DRO display showing the text *EDGE X2* in a stylized, italicized font.

4. Move the tool to position 2.



5. Press

Centering Key (Continued)

The DRO displays the following in the message window:



EDGE Y1

6. Move the tool to position 3.

7. Press 

The DRO displays the following in the message window:



EDGE Y2

8. Move the tool to position 4.

9. Press 

10. Move both axes until the displays indicate **0** (zero).

This is the centerline of the workpiece.

To exit the centering feature:

11. Press 

NOTE: To center the tool on the centerline of the X-axis only, skip the steps for the Y-axis entries. To center the tool on the centerline of the Y-axis only, press the Y-axis key after you press the centering key.

Radius/Diameter per Axis – F 05

F 05 allows you to display a specified axis in Radius or Diameter Mode. The DRO doubles axis movement and resolution In Diameter Mode. (Default for Lathe Mode: ON)

Example 1: Set one axis display in Diameter Mode.

1. Press **F** **0** **5** to select the feature.

The DRO displays the following in the message window:

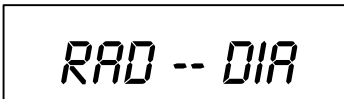

RAD -- DIA

2. Press the desired axis key to select the axis.

The DRO displays the radius-diameter mode indicator in the selected axis display.

Radius-Diameter
Mode Indicator → 

3. Press **SET** to activate the feature.

Example 2: Set two or more axis displays in Diameter Mode.

1. Press **F** **0** **5** to select the feature.

The DRO displays the following in the message window:

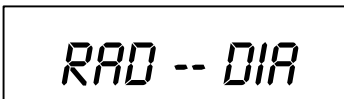

RAD -- DIA

Radius/Diameter per Axis – F 05 (Continued)

2. Press the desired axis key(s) to select the axes.

The DRO displays the radius-diameter mode indicator in the selected axis displays.

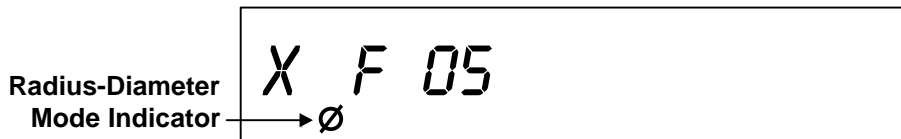

3. Press  to activate the feature.

To turn Diameter Mode OFF:

1. Press   

2. Press the axis key(s).

The DRO turns OFF the radius-diameter mode indicator symbol(s), indicating the radius-diameter mode is turned off.

Setting a Correction Factor – F 03

F 03 allows you to compensate for nominal linear inaccuracies due to your machine or for adding material shrinkage/expansion, as in mold work.

The maximum allowable settings are $\pm 40\%$.

Example: Consider a **1.325-in. (33.655 mm)** travel on the display that is only **1.320 in. (33.528 mm)** actual distance moved on the axis.

To set a correction factor for the axis:

1. Press    to activate the **CF** feature.

The DRO displays the following in the message window:



SET CORFCT





2. Press the desired axis key to select the axis.

The DRO displays the following in the axis display:



X 00000

3. Move the machine axis to **1.325** on the display.
4. Press the desired axis key again.

5. Press      to enter the actual distance.

6. Press 

Setting a Correction Factor – F 03 (Continued)

The Correction Factor (CF) indicator in the displayed axis turns ON indicating the Correction Factor is active.







100-Point Axis Error Compensation – F 80/F 81

F 80/F 81 allow you to correct non-linear errors. The DRO allows setting a compensation table with a maximum of 100 different points per axis. This feature allows you to compensate for machine tool inaccuracies.

To determine the compensation values it is necessary to measure the axis with a Laser Interferometer or other measuring device.

Axis Error Compensation is only possible if the Reference mark evaluation is activated (EverTrack™).

1. Press   
2. Press the desired axis key and 

Move the linear encoder for the axis across the reference mark until **RI** stops blinking and the display starts to count.

Measure the Axis

To measure the axis, switch the DRO to mode “REFERENCE DISPLAY”.

1. Press   

The DRO displays the following in the message window:



SEL AXIS

100-Point Axis Error Compensation F 80/F 81

(Continued)

Measure the Axis (Continued)

2. Press the desired axis key.

3. Press  key.

The DRO displays the following in the message window:





REF.DISPLAY

The decimal point in the left display field indicates that the display values are referenced to the Reference mark. If the decimal point blinks, the Reference mark has not been traversed.

Now, if required, you can set a zero to datum point for the “Reference Display”.

For example, press the desired axis and

Press   to set zero point for “Reference Display”.

Measure the axis and note the compensation values for later programming.

As the compensation is always related to the “Reference Display”, you are not allowed to change the zero or datum point for the “Reference Display” after measuring.

Press  to leave the “Reference Display” mode.

100-Point Axis Error Compensation F 80/F 81

(Continued)

Selecting the Compensation Table, Entering an Axis Compensation

1. Press **F** **8** **0**

The DRO displays the following in the message window:

SEL AXIS

5. Press the desired axis key.

The DRO displays the following in the message window:

AXIS X

6. Press **SET**

The DRO displays the following in the message window:

DATUM X

Datum point for the axis to be corrected. Here you enter the start point at which the axis with error is to be corrected. This point indicates the distance to the zero position for the "Reference Display".

100-Point Axis Error Compensation F 80/F 81

(Continued)

Selecting the Compensation Table, Entering an Axis Compensation (Continued)

Enter, for example: 0 mm

Press

The DRO displays the following in the message window:

SPACING X

Enter the spacing between the compensation points.
Factory setting: 10 mm

Enter, for example: 5 mm

Press

The DRO displays the following in the message window:

X NO. 00

. 0.000

X-axis display shows compensation point no. 0

0.000

Y-axis display shows compensation value no. 0

NOTE: Compensation point 0 always has the compensation value 0 and cannot be changed.

100-Point Axis Error Compensation F 80/F 81

(Continued)

Selecting the Compensation Table, Entering an Axis Compensation (Continued)

Press 

The DRO displays the following in the message window:

X NO. 01

. 5.000

X-axis display shows compensation point no. 1

Y-axis display shows compensation value no. 0

Enter the associated compensation value for point no. 1 and confirm with SET.
For example: 0.002 mm

Press    

Press 

The DRO displays the following in the message window:

X NO. 02

Repeat this procedure for all further compensation points (no. 2 – no. 99).

100-Point Axis Error Compensation F 80/F 81

(Continued)

Selecting the Compensation Table, Entering an Axis Compensation (Continued)

NOTE: For 1-axis version, the compensation point displays only briefly in axis display, before compensation value is shown. If you press, the **CE** key, the compensation point is shown again.

Key Functions for Compensation Table

SET

SET key: Confirm entry and page forward in the compensation table

MM
INCH

MM/INCH key: Page backward in the compensation table.

ABS
INCR

ABS/INCR key: Change to “REFERENCE DISPLAY” mode.

ADV

ADV key: Direct selection of compensation points.
Press the **ADV** key and the two-digit number of the desired compensation point.

F

Exit the compensation table.

100-Point Axis Error Compensation F 80/F 81

(Continued)

Deleting a Compensation Value Table

To delete a compensation value table:

1. Press   

The DRO displays the following in the message window:

SEL AXIS

2. Select the table for the specified axis with the axis key.



The DRO displays the following in the message window:

AXIS X

3. Press 

The DRO displays the following in the message window:

DELETE X

Delete the compensation value table with  key, or cancel with  key.

100-Point Axis Error Compensation F 80/F 81

(Continued)

Axis Error Compensation ON/OFF

1. Press **F** **8** **1**

The DRO displays the following in the message window:

99 - PT.ACTIV

A programmed error compensation can be switched ON or OFF for each axis with the axis key. If compensation is active, the red symbol “**CF**” in the corresponding display is on.

Correction Factor OFF/ON – F 04

F 04 allows you to turn the Correction Factor (**CF**) OFF or ON selectively and store the values in memory.

To turn the correction factor ON or OFF:

1. Press    to select the feature.

The DRO displays the following in the message window:



CF ON--OFF

2. Press the desired axis key to select the axis to enable or disable **CF**.
3. If necessary, turn the correction factor ON or OFF for any axis.

To clear the correction factor from memory:

1. Press   

The DRO displays the following in the message window:



SET CORFCT

2. Press the desired axis key to select the axis to clear.
3. Press the axis key twice to clear the **CF**.

4. Press 

Approaching Zero Indicator

This feature indicates that the machine is within a set range and is approaching zero.

The approaching zero indication range must be set using [Approaching Zero Range – F.07](#).

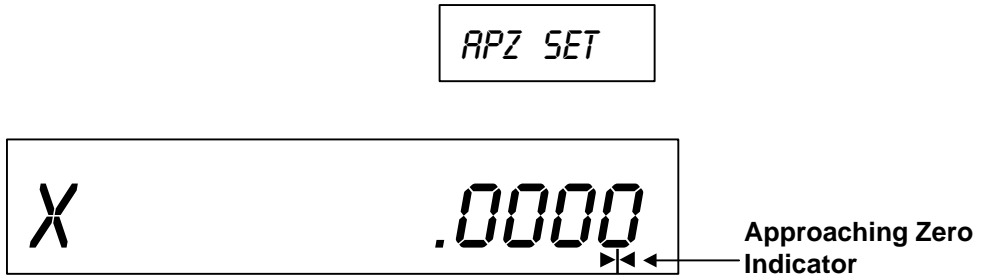

Approaching Zero – F 06

F 06 indicates when an axis is within a set range and approaching zero, or at zero.

1. Press    to select the feature.

The DRO displays the following in the message window and axis displays:

APZ SET

X F 06

Y

2. Press the desired axis key(s) to select the axes.

The DRO displays the approaching zero indicator(s) on the selected axis display(s).

APZ SET

X F 06  

Y  

3. Press  to activate the feature.

Approaching Zero – F 06 (Continued)

To turn the approaching zero indicator OFF:

1. Press **F** **0** **6** to select the feature.
2. Press the desired axis key to deselect the axis.
3. Press **SET**

NOTE: The following example shows an axis with an approaching zero position tolerance set to **.5**. The symbols in the lower right corner of the display indicate the axis is approaching zero, at zero, or past zero. The arrows indicate the direction of travel toward zero only if you preset a range using [Approaching Zero Range – F 07](#).

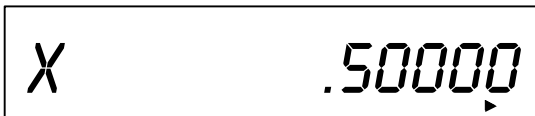

Approaching zero.

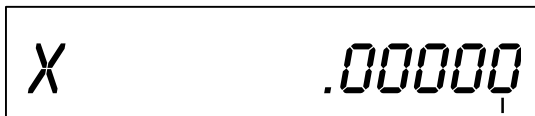

At zero.

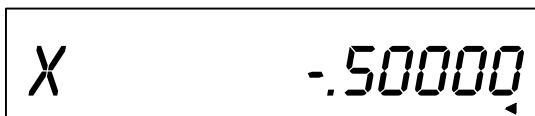

Past zero.

Approaching Zero Range – F 07

F 07 allows you to set the range for approaching zero indication in one or more axes.

Example: To set the range for the X-axis to **.5**:

1. Press    to select the feature.

The DRO displays the following in the message window:



APZ RANGE

The axis displays indicate the current approaching zero range.

2. Press axis 1 key to select the axis.

The DRO displays the following in the axis display:



X 0

The X is blinking.

3. Press  

The DRO displays the following in the axis display:



X .5

Approaching Zero Range – F 07 (Continued)

To set the range for another axis:



4. Repeat steps 2 and 3 for each axis.

5. Press  to activate the feature.

Approaching Zero Audio ON/OFF – F 08

F 08 enables/disables an audible beep to notify you when the selected axis is within the approaching zero range. (Default: OFF)

To turn on audio notification for the selected axis:

1. Press   

The DRO displays the following in the message window:

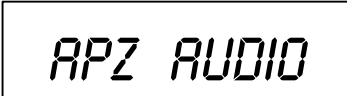

APZ AUDIO

To turn off audio notification for the selected axis:

1. Press   

The DRO displays the following in the message window:

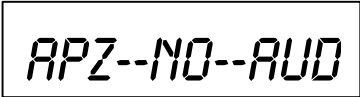

APZ--NO--AUD

Connecting the Edge Sensor Probe

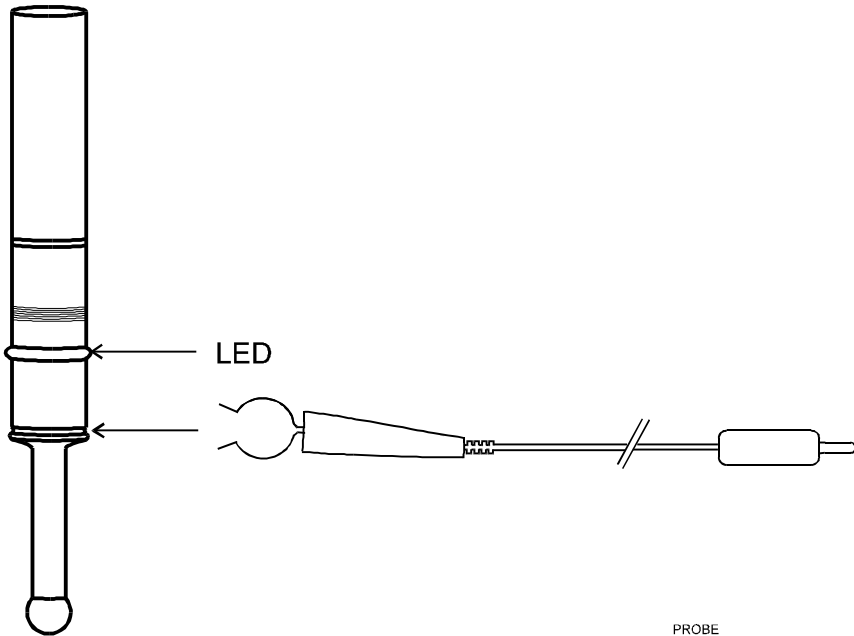

CAUTION: To avoid electrical shock, unplug the DRO from the power source.

1. Connect the ground wire on the back of the DRO to a proper earth ground.
2. Place the round spring clip in the appropriate groove on the probe.

NOTE: Ensure that the round spring clip on the probe cable is connected to the probe below the LED.

3. Plug the other end of the probe cable into the circular jack on the back of the DRO.

The red LED on the probe should glow dimly, indicating a proper connection. When you touch the probe tip to the workpiece, the red LED should glow brightly.

Edge Sensor Probe – F 09

F 09 allows you to position the spindle on the edge of the workpiece.

To activate the edge sensor probe:

1. Press **F** **0** **9**

The DRO displays the following in the message window:

PROBE EDGE

NOTE: When you move the X-axis from left to right enter a positive diameter; when you move the X-axis from right to left enter a negative diameter (See Figure 1).

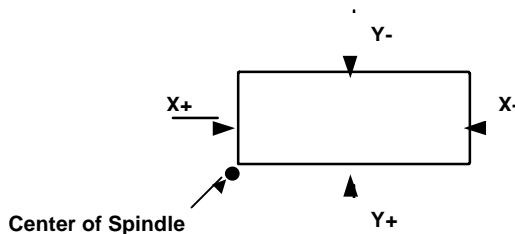

Figure 1: Selecting Direction of Movement

Example: To enter a probe diameter of **.2 in. (5.08 mm)** for the X-axis (moving from left to right):

2. Press the axis key to select the axis.

The DRO displays the following in the message window:

PROBE DIA

Edge Sensor Probe – F 09 (Continued)

To enter the probe diameter:

3. Press 

to toggle to plus or minus,
for the desired direction of
movement (See Figure 1).

4. Press   

The DRO displays the following in the message window and axis display:

PROBE X +

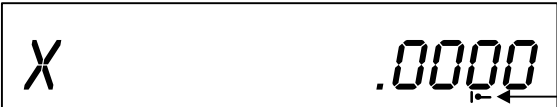
 *X* *.0000*
Edge Sensor Indicator

5. Move the edge sensor until it touches the edge of the workpiece and the edge sensor indicator turns off.
6. Move the spindle until the axis display indicates zero.

This is the edge of the workpiece.

Feedrate ON/OFF – F 26

F 26 allows you to display the maximum feedrate for all axes in the message window (if feedrate is greater than 0.4 inches per minute or greater than 10 mm per minute). The DRO displays the feedrate in inches per minute if set to **INCH** Mode and mm per minute if set to **MM** Mode. If you move two or more axes at the same time, the DRO displays the feedrate for the fastest moving axis. (Default: OFF)

To turn on the feedrate:

1. Press   

The DRO displays the following in the message window:



FEED ON

To turn off the feedrate:

1. Press   

The DRO displays the following in the message window:

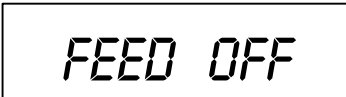

FEED OFF

Job Clock ON/OFF – F 34

F 34 allows you to toggle the DROs integrated job clock ON or OFF. When activated, the job clock displays the time in hours, minutes, and seconds in the message window.
(Default: OFF)

To turn the job clock ON:

1. Press   

The DRO temporarily displays the following in the message window:



The DRO resets the axis display windows to zero and displays the job clock in the message window.



To start or stop the job clock:

2. Press 

To reset the job clock to 0 (zero):

3. Press 

To redisplay the message window and run the job clock in the background or to redisplay the job clock:

4. Press 

Job Clock ON/OFF – F 34 (Continued)

To turn the job clock OFF:

1. Press   

The DRO temporarily displays the following in the message window:



CLOCK OFF

The DRO clears the job clock display in the message window and resets the axis display windows to **0** (zero).

Parameter Settings – F 20

F 20 allows you to set up encoder parameters and axis display resolutions. The following section describes two different types of resolution:

- ❑ [Encoder Resolution](#) the resolution of the measurement, an encoder parameter.
- ❑ [Display Resolution](#) the resolution of displayed values.

You can vary the resolution of the values displayed in the linear axis displays for both **INCH** and **MM** Mode. For a rotary axis, you can set up the display resolution for degrees in both decimal and minutes/seconds format. You can set the display resolution individually for each axis.

F 20 allows you to enter parameters for the encoders used for feedback. These can be set up individually for each axis. Your DRO will support three different types of encoders:

- ❑ [Metric Linear Encoders](#) (encoders with grating pitch measured in microns, μm)
- ❑ [Inch-Based Linear Encoders](#) (encoders with grating pitch measured in inches)
- ❑ [Rotary Encoders](#)

All modern linear encoders are of the Metric type.

NOTE: **F 20** is also used to specify the parameters of the spindle encoder used for feedback for Spindle Speed Display (SSD). See [Parameter Setting for SSD \(2-Axis and 3-Axis With SSD Option Only\)](#).

Setting Up Encoder Parameters

To enter encoder and axis display parameter settings:

1. Press    to select the feature.

The DRO displays the following in the message window:



PARAMETER

2. Press the desired axis key(s) to select the axes.

Parameter Settings – F 20 (Continued)

NOTE: You can select one or more axes to set up simultaneously as long as they use the same encoders and the same display format is desired. You must repeat the **F 20** feature and select the appropriate axis (axes) for each different type of encoder setup.

The DRO displays the following in the message window:

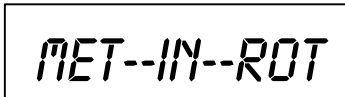

MET--IN--ROT

The axis display indicates the encoder type (default **Metric**).

The available encoder types are:

- Metric** Metric Linear Encoders
- Inch** Inch-Based Linear Encoders
- Rot** Rotary Encoders

3. Press  repeatedly to scroll through the encoder type options.

4. Press  to set the desired encoder type option.

NOTE: Most linear encoders, and all modern ANILAM encoders are metric, i.e., they have a grating pitch measured in microns (μm). Some older linear encoders (for example, **BT** and **JB** type encoders) are inch-based, i.e., they have a grating pitch measured in inches. Select **rot** if the encoder is a rotary encoder.

Go to the section for the selected type of encoder:

- [Metric Linear Encoders](#)
- [Inch Linear Encoders](#)
- [Rotary Encoders](#)

Parameter Settings – F 20 (Continued)

Metric Linear Encoders

If you have performed steps 1 through 4 in the [Setting Up Encoder Parameters](#) section and selected Metric Linear Encoder, the DRO prompts for the encoder resolution and direction of positive travel in the message window, and displays the default encoder resolution (**5µm**) in the axis display:

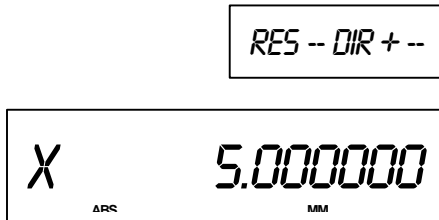

The axis designation (in this example, **X**) is blinking, indicating that you can enter a value. The default value for the encoder resolution is **5mm**. The encoder resolution value must be set for the linear encoder type you are using.

The following table lists the encoder resolution (in microns) for common ANILAM encoders:

| Linear Encoder Type | Encoder Resolution |
|--|--------------------|
| RBS-05T, RBM-05T | .5 |
| RBS-1, RBS-1T, RBM-1T, B-1, E-1 | 1 |
| RBS-2, A-2, C-2, E-2, F-2, | 2 |
| RBS-5, RBS-5T, RBM-5T, PGS-E, PGS-P, B-5, C-5, E-5, KM-5, | 5 |
| 5 micron resolution Rack and Pinion | |
| RBS-10, A-10, C-10, D-10, KM-10 | 10 |
| 10 micron resolution Rack and Pinion | |

Parameter Settings – F 20 (Continued)

Setting Encoder Resolution

If you need to change the encoder resolution setting – for example, **1 μm**:

1. Press 

If you need to change the direction of positive travel:

2. Press 

to change the direction of positive travel.

3. Press 

and direction of travel.

to set the encoder resolution

Setting Display Resolution (MM Mode)

The DRO displays the following in the message window and axis display(s):

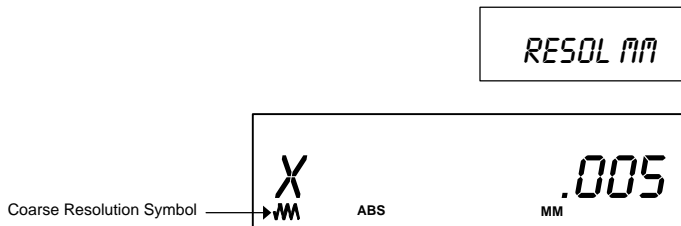

This is the display resolution measured in **MM** for the axis display(s) when the **MM/INCH** key has been toggled to **MM** Mode only. The axis designation (in this example, **X**) is blinking, indicating that you can enter a value. The DRO will default the same display resolution as the encoder resolution. ANILAM recommends that you use the same display resolution as you use for the encoder resolution.

NOTE: The DRO turns on the Coarse Resolution Symbol in the axis display(s) if the selected display resolution is coarser than the encoder resolution.

Parameter Settings – F 20 (Continued)

1. Press  repeatedly to scroll through the display resolution options in MM Mode.

2. Press  to select the desired display resolution in MM Mode.

Setting Display Resolution (INCH Mode)

The DRO displays the following in the message window and axis display:

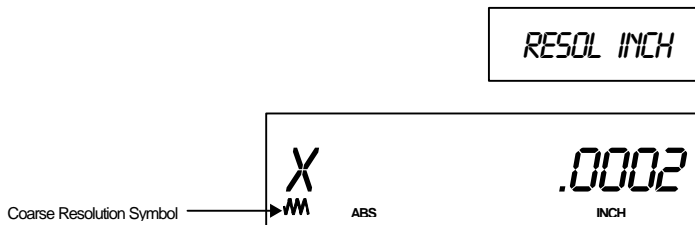

This is the display resolution measured in inches for the axis display(s) when the **MM/INCH** key has been toggled to **INCH** Mode only. The axis designation (in this example, **X**) is blinking, indicating that you can enter a value. The DRO will default the same display resolution as the encoder resolution. ANILAM recommends that you use the same display resolution as you use for the encoder resolution.

NOTE: The DRO turns on the Coarse Resolution Symbol in the axis display(s) if the selected display resolution is coarser than the encoder resolution.

1. Press  repeatedly to scroll through the display resolution options in INCH Mode.

Parameter Settings – F 20 (Continued)

To change the Resolution Setting:

2. Press  to select the desired display resolution in INCH Mode.

Setting EverTrack™ Mode

The DRO prompts for the EverTrack™ Mode in the message window and displays the default EverTrack™ Mode in the axis display:

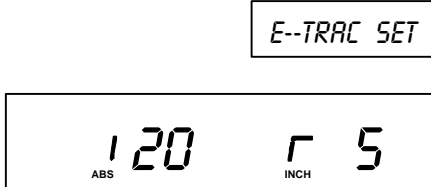

The available settings are:

| Setting | | Linear Encoder |
|-----------|-----|-----------------------------|
| i20 | r05 | RBS-05T and RBM-05T |
| i20 | r1 | RBS-1T and RBM-1T |
| i20 | r5 | RBS-5T and RBM-5T (default) |
| no E-trac | | All other linear encoders |

1. Press  repeatedly to scroll through the options.

2. Press  to set the option and exit.

Parameter Settings – F 20 (Continued)

Inch Linear Encoders (BT or JB Linear Encoders)

If you have performed steps 1 through 4 in the [Setting Up Encoder Parameters](#) section and selected **Inch Linear Encoder**, the DRO prompts for the encoder resolution and direction of positive travel in the message window:

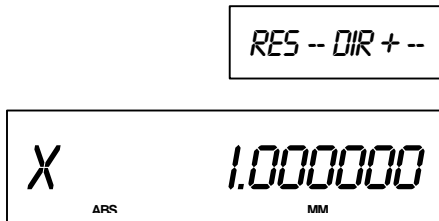

The axis designation (in this example, **X**) is blinking, indicating that you can enter a value. The default value for the encoder resolution is **.0001 in.** (display resolution is in ten thousands of an inch). The encoder resolution value must be set for the linear encoder type you are using.

NOTE: If you do not know the encoder resolution for the linear encoder(s) you are using, call ANILAM at the number listed on page 1.

Setting Encoder Resolution

If you need to change the encoder resolution setting – for example, **.0002 in.:**

1. Press 

If you need to change the direction of positive travel:

2. Press  

to change the direction of positive travel and to set the encoder resolution.

3. For the remainder of the inch linear encoder parameter setup procedures, proceed with [Setting Display Resolution \(MM Mode\)](#) after step 7 of the [Metric Linear Encoders](#) section.

Parameter Settings – F 20 (Continued)

Rotary Encoders

If you have performed steps 1 through 4 in the [Setting Up Encoder Parameters](#) section and selected **rot** (Rotary Encoder), the DRO prompts for the Line Count in the message window. The default rotary encoder line count (**9000**) is displayed in the axis display:

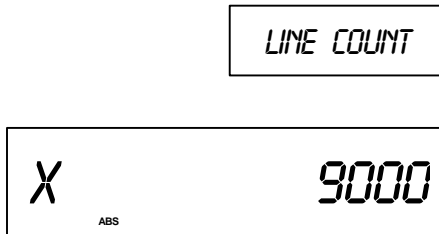

The axis designation (in this example, **X**) is blinking, indicating that you can enter a value. The default value for the encoder resolution is **9000**. The encoder resolution value must be set for the linear encoder type you are using.

Changing the Line Count and Direction of Positive Rotation

If you need to change the line count – for example: **18000**:

1. Press     

If you need to change the direction of positive rotation:

2. Press 

to change the direction of positive rotation.

3. Press 

to select the direction of rotation and line count.

Parameter Settings – F 20 (Continued)

Setting Display Resolution (Display Degrees in Decimal Mode)

The DRO displays the following in the message window and the axis display:

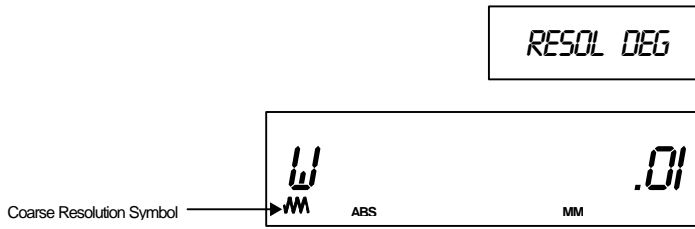

This is the display resolution for the axis display(s) when you set the DRO to display degrees in Decimal Mode only. The axis designation (in this example, **W**) is blinking, indicating that you can enter a value. The DRO will default the same display resolution as the encoder resolution (in this example, **.01 Degrees**). ANILAM recommends that you use the same display resolution as you use for the encoder resolution.

The available display options are:

Display Resolution Options in Decimal Degree Mode

.0005, .001, .002, .005, .01, .02, .05, .1, .2, .5, 1

NOTE: The DRO turns on the Coarse Resolution Symbol in the axis display(s) if the selected display resolution is coarser than the encoder resolution.

1. Press  repeatedly to scroll through the options.

To select the display resolution:

2. Press 

Parameter Settings – F 20 (Continued)

The DRO displays the following in the message window and the axis display:



This is the display resolution for the axis display(s) when you set the DRO to display degrees in minutes and seconds mode only. The axis designation (in this example, **W**) is blinking, indicating that you can enter a value. The DRO will default the same display resolution as the encoder resolution (in this example, **30 seconds**). ANILAM recommends that you use the same display resolution as you use for the encoder resolution.

The available display options are:

Display Resolution Options in Minutes and Seconds Mode

.00.01, .00.02, .00.05, .00.10, .00.20, .00.30, .01, .02, .05, .10, .20

NOTE: The DRO turns on the Coarse Resolution Symbol in the axis display(s) if the selected display resolution is coarser than the encoder resolution.

3. Press  repeatedly to scroll through the options.

To select the display resolution:

4. Press 

Parameter Settings – F 20 (Continued)

Resetting Parameters to Factory Settings

To reset all parameter settings to their original factory settings:

1. Press  for approximately 5 seconds.

To cancel the reset:

2. Press  again.

OR



To reset all parameters:

1. Press 

Display Dim OFF/ON – F 22/F 23

F 22 allows you to activate Dim Mode; **F 23** allows you to deactivate Dim Mode. To increase the life of the display, the DRO automatically dims if it is not used for 15 minutes (similar to a computer terminal's screen-saver mode). When you activate Dim Mode the axis displays show blinking decimal points. The DRO remains in Dim Mode until you press a key or move one or more linear encoders. (Default: ON)

To select DIM ON:

1. Press   

The DRO displays the following in the message window:

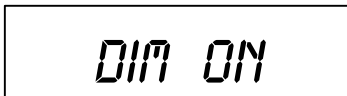

DIM ON

To select DIM OFF:

1. Press   

The DRO displays the following in the message window:

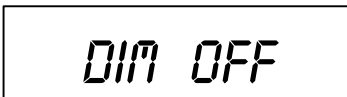

DIM OFF

NOTE: You can disable this feature, however the DRO still goes into Dim Mode after standing idle for one hour.

Axis Designation – F 24

F 24 allows you to assign an axis to each display you select. You can change the assignment of any axis to **X, Y, Z, W, Z₁, X₁** or no axis designation.

1. Press    to select the feature.

The DRO displays the following in the message window and axis display:

NAME AXIS

X F 24

2. Press the desired axis key to scroll through the available settings.

3. Press  to activate the axis assignment.

OR

4. Press  to exit without changing the axis assignment.

Select Language – F 99

F 99 allows you to select the language the DRO will use to display text and messages.

The available languages are:

- English
- German
- French
- Italian
- Spanish
- Swedish
- Czech
- Portuguese

To select the language:

1. Press

F

9

9

The DRO displays the selected language in the message window:

ENGLISH

Linear Encoder Error Detect OFF/ON – F 40/F 41

Your DRO has advanced Linear Encoder error-checking capability. This feature determines if there are any Linear Encoder miscounts or repeatability problems. **F 40** allows you to turn OFF Linear Encoder Error Detect; **F 41** allows you to turn ON Linear Encoder Error Detect. (Default: ON)

To turn OFF the Linear Encoder Error Detect feature and deactivate all axes:

1. Press   

The DRO momentarily displays the following in the message window:



ENCERR OFF

To turn ON Linear Encoder Error Detect and activate all axes:

1. Press   

The DRO momentarily displays the following in the message window:



ENCERR ON

If the DRO detects an error, it displays the error in that axis display. The other axis displays remain blank for a short time and then the beeper sounds.

For example:





X ERROR

Diagnostics – F 45

F 45 allows you to perform system diagnostic tests on the keyboard, internal EEPROM, and internal counters. If any of these tests fail, contact your local distributor or ANILAM Customer Services. You do not need to unplug the linear encoders for these tests.

Display Test

1. Press   

to display all segments of the display and message window.

EEProm Test

2. Press 

to activate the internal EEPROM test.

The DRO displays the results in the axis window:

EEProm nF (no fail).
EEPR. FAIL

Counters Test

3. Press 

to activate the internal counters test.

The DRO displays the results in the axis window:



Count nF (no fail).
CNT FAIL

Diagnostics – F 45 (Continued)

Keyboard Test

4. Press  to activate the keyboard test.
5. Press any key on the DRO to display the key on the DRO display.

Blank Test

6. Press  for 2 seconds to blank all segments of the display.
7. Press  to end the system diagnostics test.

Mill/Lathe Setup (900 Only) – F 29

F 29 allows you to set up the DRO to operate in Mill or Lathe Mode. (Default is Mill)

To set up the DRO in Mill or Lathe Mode:

1. Press   

The DRO displays one of the following in the message window:

MILL

LATHE

2. Press 

to toggle between the Mill and Lathe Mode setting.

3. Press 

to activate the setting.

Advanced (ADV) Functions Key

The Advanced Functions Key allows you to access the following DRO advanced functions:

- [Help for DRO Features](#)
- [Bolt-Hole Patterns](#) (N/A for 900, Lathe Mode)
- [Linear-Hole/Frame Hole Patterns](#) (N/A for 900, Lathe Mode)
- [Taper Calculation](#) (900, Lathe Mode Only)
- [Skew Compensation](#) (900, Mill Mode Only)

NOTE: To select Mill or Lathe Mode for a 900, use [Mill/Lathe Setup – F 29](#).

To access the Advanced functions:

1. Press 

The DRO displays the following in the message window:



2. Press 

repeatedly to scroll through the functions list.

Help Function

HELP allows you to scroll through a list of feature names and their codes or quickly access a DRO feature from the list.

To display the list of features and their codes:

1. Press 

Advanced (ADV) Functions Key (Continued)

The DRO displays the following in the message window:

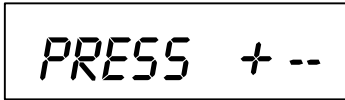

PRESS + --

2. Press



repeatedly to scroll through
the feature list.

The DRO displays the following in the message window and axis display 1:

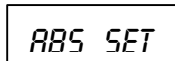

ABS SET



F01

Each time you press the plus/minus key, the DRO displays the next feature code in axis display 1 and the feature name in the message window.

To reverse the scrolling direction:

3. Press



To activate a displayed feature:

4. Press



To exit the Help function:

5. Press



Advanced (ADV) Functions Key (Continued)

Bolt-Hole Pattern Function (N/A for 900, Lathe Mode)

The **Bolt-Hole Pattern** function allows you to program the X and Y positions for a maximum of 10 different bolt-hole patterns (maximum 360 holes each) around the circumference of a specified circle. The DRO can program the following types of bolt-hole patterns:

- [Partial Pattern](#) In a partial pattern, the holes do not cover the entire circumference of the circle. Instead they form an arc, called a partial pattern. (See Figure 2)
- [Full Pattern](#) In a full pattern, the holes cover the entire circumference of the circle. (See [Figure 3](#))

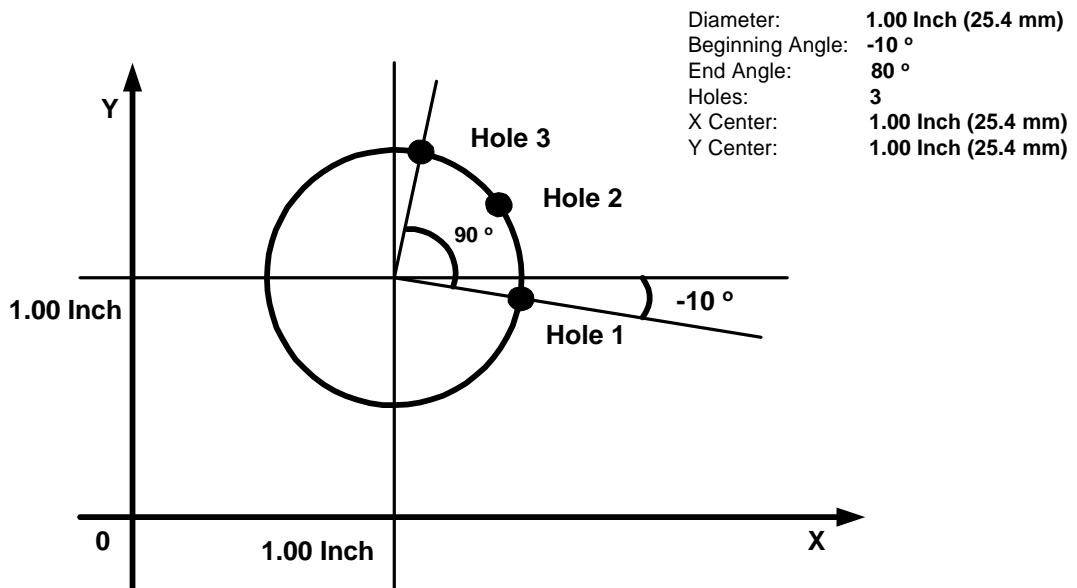

Figure 2: Partial Bolt-Hole Pattern

Advanced (ADV) Functions Key (Continued)

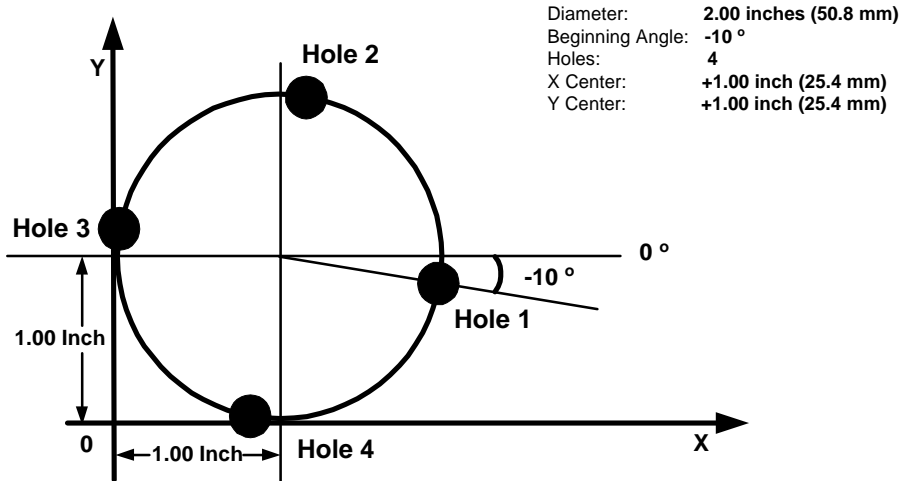

Figure 3: Full Bolt-Hole Pattern

To access the Bolt-Hole pattern function:

1. Press **ADV** repeatedly to scroll through the Advanced Functions list.

When the DRO displays the following in the message window:

BOLT HOLE

2. Press **ENT**

The DRO displays the following in the message window:



BHP NUMBER

Advanced (ADV) Functions Key (Continued)

NOTE: If you are entering a full bolt-hole pattern, skip this section and go to the [Full Bolt-Hole Pattern](#) section.

Partial Bolt-Hole Pattern

To enter a partial bolt-hole pattern for program number 1 (Range is 0 through 9):

1. Press  

The DRO displays the following in the message window:



FULL

To enter a partial bolt-hole pattern:

2. Press 

The DRO displays the following in the message window:



PARTIAL

3. Press 

The DRO displays the following in the message window and axis display 1:

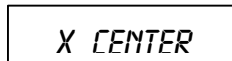

X CENTER



X .0000

Advanced (ADV) Functions Key (Continued)

To enter the X dimension for the center of the pattern – for example, **1.00 in. (25.4 mm)**:

4. Press  

The DRO displays the following in the message window and axis display 2:

Y CENTER

Y *.0000*

To enter the Y dimension for the center of the pattern – for example, **1.00 in. (25.4 mm)**:



5. Press  

The DRO displays the following in the message window and axis display 1:

BHP DIA

X *.0000*

To enter the diameter of the bolt-hole pattern – for example, **1.00 in. (25.4 mm)**:

6. Press  

Advanced (ADV) Functions Key (Continued)

The DRO displays the following in the message window and axis display 1:

BTY HOLE

X

0

To enter the number of bolt-hole patterns (maximum 360 holes) – for example, **3**:

3

ENT

7. Press

The DRO displays the following in the message window and axis display 1:

BEG ANGLE

X

.0000

To enter the beginning angle for the first hole (measured in a counter clockwise direction) – for example, **-10** degrees:

±

1

0

ENT

8. Press

The DRO displays the following in the message window and axis display 1



END ANGLE

X

360.0

Advanced (ADV) Functions Key (Continued)

To enter the end angle for the pattern (measured in a counter clockwise direction) – for example, for **80** degrees:

9. Press   

The DRO temporarily displays the following in the message window:



BHP DONE

Advanced (ADV) Functions Key (Continued)

Full Bolt-Hole Pattern (N/A for 900, Lathe Mode)

To access the Full Bolt-Hole Pattern function:

1. Press  repeatedly to scroll through the Advanced Functions list.

When the DRO displays the following in the message window:



BOLT HOLE



2. Press 

The DRO displays the following in the message window:



BHP NUMBER

To enter a full bolt-hole pattern for program number **2** (Range is 0 through 9):

3. Press  

The DRO displays the following in the message window:



PARTIAL

4. Press 

Advanced (ADV) Functions Key (Continued)

The DRO displays the following in the message window:

FULL

ENT

5. Press

The DRO displays the following in the message window and axis display 1

X CENTER

X *.0000*

To enter the X dimension for the center of the pattern – for example, **1.00 in. (25.4 mm)**:

1

ENT

6. Press

The DRO displays the following in the message window and axis display 2

Y CENTER

Y *.0000*

To enter the Y dimension for the center of the pattern – for example, **1.00 in. (25.4 mm)**:

1

ENT

7. Press

Advanced (ADV) Functions Key (Continued)

The DRO displays the following in the message window and axis display 1

BHP DIA

X

.0000

To enter the diameter of the bolt-hole pattern – for example, **2.00 in. (50.8 mm)**:

8. Press

2

ENT

The DRO displays the following in the message window and axis display 1

QTY HOLE

X

0

To enter the number of bolt-hole patterns (maximum 360 holes) – for example, **4**:

9. Press

4

ENT

The DRO displays the following in the message window and axis display 1



BEG ANGLE

X

.0000

Advanced (ADV) Functions Key (Continued)

To enter the beginning angle for the first hole (measured in a counter clockwise direction) – for example, **-10** degrees:

10. Press    

The DRO temporarily displays the following in the message window:



BHP DONE

Advanced (ADV) Functions Key (Continued)

Recalling Bolt-Hole Pattern Function (N/A for 900, Lathe Mode)

The Recall Key (**RCL**) allows you to recall a maximum of 10 previously programmed bolt-hole patterns.

To recall bolt-hole pattern number **1** programmed in the previous section:

1. Press  repeatedly to scroll through the Advanced Functions list.

When the DRO displays the following in the message window:

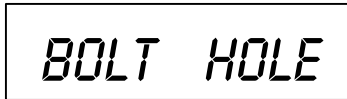



BOLT HOLE

2. Press 

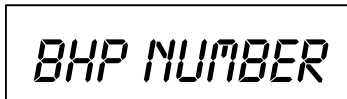
The DRO displays the following in the message window:



BHP NUMBER

3. Press  

Advanced (ADV) Functions Key (Continued)

The DRO displays the following in the message window and the axis displays:

1 HOLE 001

X -1.4924

Y -.9132

The message window indicates bolt-hole pattern number **1** and hole number **1**. The axis displays show the distance to hole number **1**.

4. Move the machine until the axis displays indicate zero and drill the hole.

To recall the distance to hole number **2**:

RCL

5. Press

The DRO displays the following in the axis displays and the message window:

2 HOLE 002

X +.0828

Y -.3736

Advanced (ADV) Functions Key (Continued)

The message window indicates bolt-hole pattern number **2** and hole number **2**. The axis displays show the distance to hole number **2**.

6. Move the machine until the axis displays indicate zero and drill the hole.

To recall the distance to hole number **3**:

7. Press 

The DRO displays the following in the axis displays and the message window:

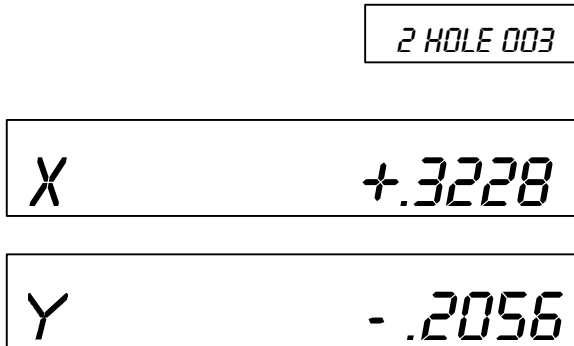

After you drill the last hole in the pattern the DRO returns to hole **1** and displays the following in the message window:

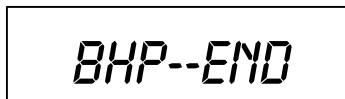

The DRO displays the incremental distance from the absolute zero position in the axis displays.

To exit the Recall function:

8. Press 

Advanced (ADV) Functions Key (Continued)

Linear-Hole/Frame-Hole Pattern Function (N/A for 900, Lathe Mode)

The **Linear Hole** pattern function allows you to program a combination of 10 different linear-hole patterns or frame-hole patterns. Each pattern can include a maximum of 999 holes.

To access the Linear-Hole function:

1. Press  repeatedly to scroll through the Advanced Functions list.

When the DRO displays the following in the message window:

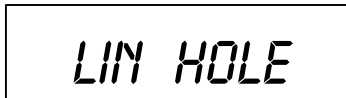

LIN HOLE

2. Press 

The DRO displays the following in the message window:

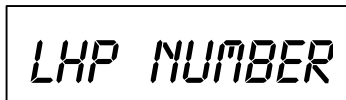

LHP NUMBER

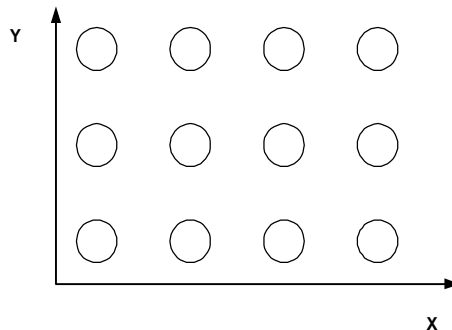

Figure 4: Linear-Hole Pattern

Advanced (ADV) Functions Key (Continued)

To program a linear-hole pattern (Range is 0 through 9) – for example, linear-hole pattern number 3:

3. Press **3**

The DRO displays the following in the message window:

LIN HOLE

If you are programming a linear-hole pattern go to step 5.

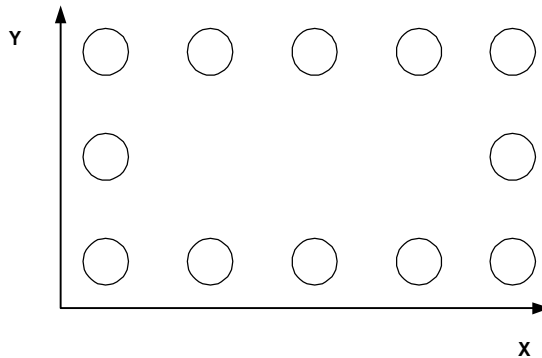

Figure 5: Frame-Hole Pattern

To select Frame-Hole Pattern:

4. Press **+**

The DRO displays the following in the message window:

FRAME HOLE

Advanced (ADV) Functions Key (Continued)

To enter a frame-hole pattern:



5. Press 

The DRO displays the following in the message window:



X HOLE 1

To enter the dimension for hole 1 on the X-axis – for example, **1.00 in. (25.4 mm)**:



6. Press  

The DRO displays the following in the message window:



Y HOLE 1

To enter the dimension for hole 1 on the Y-axis – for example, **1.00 in. (25.4 mm)**:

7. Press  

Advanced (ADV) Functions Key (Continued)

The DRO displays the following in the message window:

QTY HOLE X

To enter the number of holes on the X-axis – for example, **4**:

8. Press

The DRO displays the following in the message window:

X -- X CENT

To enter the incremental distance between holes on the X-axis – for example, **1.00 in.** (**25.4 mm**):

9. Press

The DRO displays the following in the message window:

QTY HOLE Y

To enter the number of holes on the Y-axis – for example, **4**:



10. Press

Advanced (ADV) Functions Key (Continued)

The DRO displays the following in the message window:

Y--Y CENT

To enter the incremental distance between holes on the Y-axis – for example, **1.00 in.** (**25.4 mm**):

11. Press  

The DRO displays the following in the message window:

X004 Y004

The message window indicates the calculated holes in the X-axis (4 holes) and the Y-axis (4 holes). This equals a total of 16 holes (4 X-holes x 4 Y-holes). The maximum number of holes you can program is 999 holes.

To activate the settings and exit the Frame Hole function:

12. Press 

OR

To exit the Frame-Hole function without activating the settings:

13. Press 

Advanced (ADV) Functions Key (Continued)

Recalling Linear-Hole/Frame-Hole Function (N/A for 900, Lathe Mode)

The Recall Key (**RCL**) allows you to recall a maximum of 10 previously programmed linear bolt-hole patterns.

To recall linear-hole pattern number **3** programmed in the previous section:

1. Press  repeatedly to scroll through the Advanced Functions list.

When the DRO displays the following in the message window:



LIN HOLE

2. Press 

The DRO displays the following in the message window:



LHP NUMBER

To recall linear-hole pattern number **3** programmed in the previous section:

3. Press 

Advanced (ADV) Functions Key (Continued)

The DRO displays the following in the axis displays and the message window:

1 HOLE 001

X -1.9848

Y -.8264

The message window indicates bolt-hole pattern number 1 and hole number 1. The axis displays show the distance to hole number 1.

4. Move the machine until the axis displays indicate zero and drill the hole.

To recall the distance to hole number 2:

RCL

5. Press

The DRO displays the following in the axis displays and the message window:

2 HOLE 002

X +.8110

Y -1.1584

Advanced (ADV) Functions Key (Continued)

The message window indicates bolt-hole pattern number **2** and hole number **2**. The axis displays show the distance to hole number **2**.

6. Move the machine until the axis displays indicate zero and drill the hole.
7. Repeat these procedures until you have completed all holes in the linear-hole pattern.

To exit the Recall Linear-Hole Pattern function:

8. Press 

Advanced (ADV) Functions Key (Continued)

Taper Calculator Function (900, Lathe Mode Only)

The **Taper Calculator** function allows you to preset a taper angle on the lathe cross slide attachment without having to make a test cut. This function can also be used to calculate the taper on a workpiece.

To access the Taper Calculator function:

1. Press  repeatedly to scroll through the Advanced Functions list.

When the DRO displays the following in the message window:



TAPER CALC

2. Press 

The DRO displays the following in the message window:

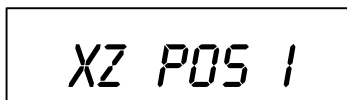

XZ POS 1

Example:

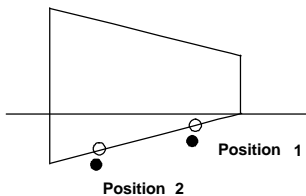

To calculate the taper angle for this example:

3. Move to position 1.

Advanced (ADV) Functions Key (Continued)

4. Press 

The DRO displays the following in the message window:

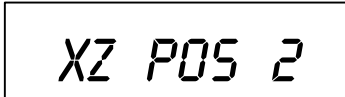

XZ POS 2

5. Move to position 2.

6. Press 

The DRO displays the taper angle in the message window:

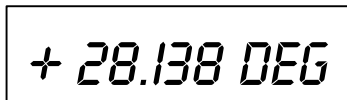

+ 28.138 DEG

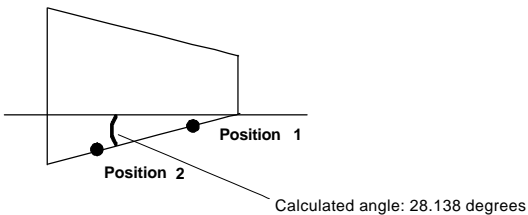

To exit the Taper Calculator function:

7. Press  or 

Advanced (ADV) Functions Key (Continued)

Skew Compensation (900, Mill Mode Only)

Skew compensation allows you to drill holes on a workpiece without aligning the workpiece on the machine. This feature can electronically align the workpiece on the machine for setup. Use this feature only for drilling holes.

To access the Skew Compensation function:

1. Press  repeatedly to scroll through the Advanced Functions list.

When the DRO displays the following in the message window:

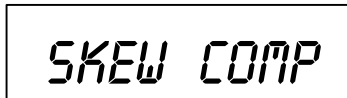

SKEW COMP

2. Press 

Example:

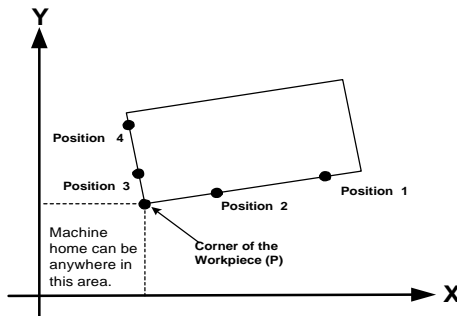



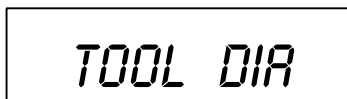

The DRO displays the following in the message window:



TOOL DIR

Advanced (ADV) Functions Key (Continued)

To enter the diameter of the tool or edge sensor probe – for example, **.25 in. (6.35 mm)**:

3. Press    

The DRO turns off the axis displays and displays the following in the message window:



HOME POS

4. Move to the machine home position.

5. Press 

The DRO displays the following in the message window:

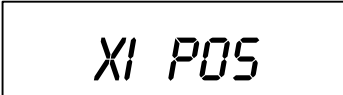

X1 POS

6. Move to position 1 and touch the workpiece with the tool or edge sensor probe.

7. Press 

The DRO displays the following in the message window:

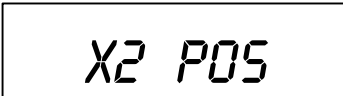

X2 POS

8. Move to position 2 and touch the workpiece with the tool or edge sensor probe.

9. Press 

Advanced (ADV) Functions Key (Continued)

The DRO displays the following in the message window:

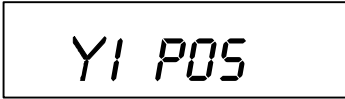

Y1 POS

10. Move to position 3 and touch the workpiece with the tool or edge sensor probe.

11. Press 

The DRO displays the following in the message window:

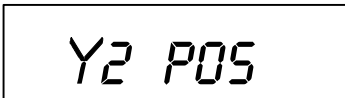

Y2 POS

12. Move to position 4 and touch the workpiece with the tool or edge sensor probe.

13. Press 

The DRO displays the following in the message window:



SKEW ON

14. Move the quill to the up position.

15. Move the machine until the X-axis and Y-axis indicate zero.

This is the corner of the workpiece (P).

16. Recall information from the Electronic Notepad and move to zero.

Advanced (ADV) Functions Key (Continued)

The DRO automatically compensates for the misaligned workpiece on the machine.

To exit the Skew Compensation feature:

17. Press 

NOTE: When you recall a program with activated skew compensation, the DRO displays a blinking **S** on the left side of the message window.

Datum/Tool Offset Key

The Datum/Tool Offset Key is a dual-function key. When you set the DRO in 900, Mill Mode or 900E, the key functions as the Datum Key. When you set the DRO in 900, Lathe Mode, the key functions as the Tool Offset Key.

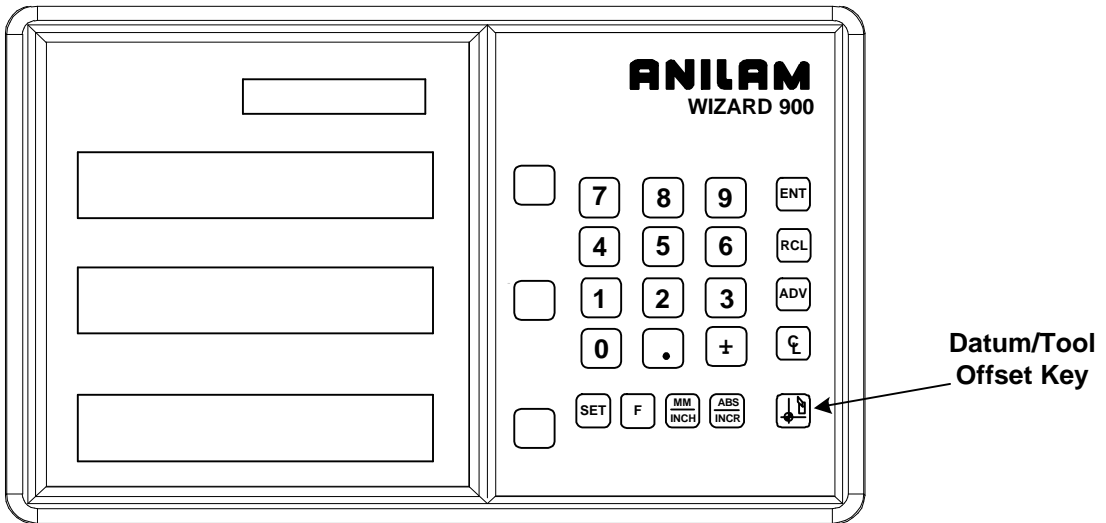

Datum Key (N/A for 900, Lathe Mode)

The Datum Key allows you to enter a datum table (maximum 99 datum points). A datum is a point or reference location, from which you can machine a part. Datum points allow you to machine similar programs on different parts. After you machine a group of parts, you can place a new group on the machine and machine the same programs on the new parts.

NOTE: Before you enter a datum table, establish a machine home position using [Absolute Zero Set – F 01](#) or activate [EverTrack™ Mode – F 02](#).

Example:

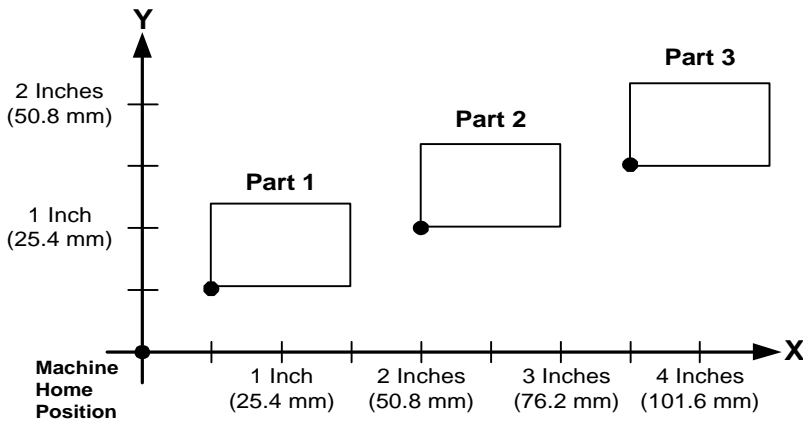

Enter Datum

To enter a datum table for the above example:

1. After power on, establish a machine home position using [Absolute Zero Set – F 01](#) or activate [EverTrack™ Mode – F 02](#).
2. Move the tool to the home position (indicated by the black dot).
3. Establish a part zero using [Absolute Zero Set – F 01](#).

Datum 0, machine home is set.



4. Move the tool to the corner of part 1 (indicated by the black dot).

Datum (N/A for 900, Lathe Mode) (Continued)

5. Press 

The DRO displays the following in the message window:

DATUM 00

6. Press  

The DRO displays the following in the message window:

DATUM 01

7. Establish a part zero using [Absolute Zero Set – F 01](#).



Datum 1 is set.

8. Move the tool to the corner of part 2 (indicated by the black dot).

9. Press 

The DRO displays the following in the message window:

DATUM 01

10. Press  

Datum Key (N/A for 900, Lathe Mode) (Continued)

The DRO displays the following in the message window:



DATUM 02

11. Establish a part zero using [Absolute Zero Set – F 01](#).

Datum 2 is set.

12. Move the tool to the corner of part 3 (indicated by the black dot).



13. Press

The DRO displays the following in the message window:



DATUM 02



14. Press

The DRO displays the following in the message window:



DATUM 03

15. Establish a part zero using [Absolute Zero Set – F 01](#).

Datum 3 is set.

Datum Key (N/A for 900, Lathe Mode) (Continued)

Enter Datum (Alternate Method)

If you know the axis locations for the corner of the parts, you can enter the datum table for the previous example without moving the tool from the machine home position as follows:

1. After power on, establish a machine home position using [Absolute Zero Set – F 01](#) or activate [EverTrack™ Mode – F 02](#).

To enter datum 1:



2. Press   

3. Press the axis key for the X-axis.

4. Press  

to enter the X-axis value,
.5 in. (12.7 mm).

5. Press the axis key for the Y-axis.



6. Press  

to enter the Y-axis value,
.5 in. (12.7 mm).

7. Press 

to set datum 1.

To enter datum 2:

8. Press   

Datum Key (N/A for 900, Lathe Mode) (Continued)

9. Press the axis key for the X-axis.



10. Press  to enter the X-axis value, **2 in. (50.8 mm)**.

11. Press the axis key for the Y-axis.

12. Press  to enter the Y-axis value, **1 in. (25.4 mm)**.

13. Press  to set datum 2.

To enter datum 3:

14. Press   

15. Press the axis key for the X-axis.

16. Press    to enter the X-axis value, **3.5 in. (88.9 mm)**.

17. Press the axis key for the Y-axis.

18. Press    to enter the Y-axis value, **1.5 in. (38.1 mm)**.

19. Press  to set datum 3.

Datum Key (N/A for 900, Lathe Mode) (Continued)

Recall Datum

Recall Datum allows you to recall a preset datum.

Example: To recall datum 1 from the previous example:

1. Press   

While the datum is activated, the DRO displays the following in the message window:



DATUM 01

2. Move the X-axis and Y-axis until the axis displays indicate **0** (zero).

This is the location for Datum 1.

3. Perform the machine process on part 1.

To return to the machine home position (datum 0):

4. Press   

5. Move the X-axis and Y-axis until the axis displays indicate zero (0).

This is the location for the machine home position (datum 0).

Datum Key (N/A for 900, Lathe Mode) (Continued)

Clear Datum – F 31

Clear Datum (F 31) allows you to clear all preset datum points (maximum 99) before entering new information.

To clear all datum points:

1. Press   

The DRO temporarily displays the following in the message window:

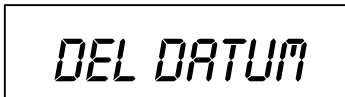

DEL DATUM

When the DRO resets the message window and axis displays, it clears all preset datum values from memory.

Tool Offset Key (900, Lathe Mode Only)

The Tool Offset Key allows you to preset X and Z offsets for each tool into a tool table (maximum 99). This feature requires an interchangeable tool system.

NOTE: Before entering a tool offset, establish a machine home position using [Absolute Zero Set – F 01](#) or activate [EverTrack™ Mode – F 02](#).

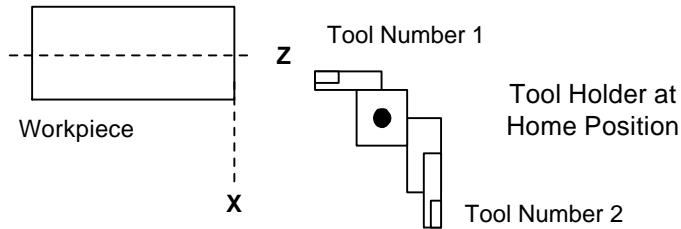

Enter Tool Offset



Example: To enter an offset for a tool:

1. Press 

The DRO displays the following in the message window:

TOOL 00

To select the tool number – for example, tool number 1:

2. Press  

The DRO displays the following in the message window:

TOOL 01

Tool Offset Key (900, Lathe Mode Only) (Continued)

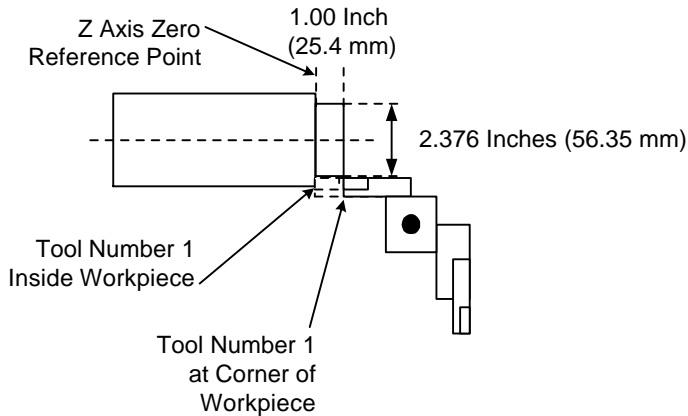

3. Move the tool to the workpiece and make a skim cut on the diameter, about **1 in. (25.4 mm)**, to allow a micrometer to measure the workpiece.
4. Measure the diameter of the workpiece. The measurement in the example is **2.376 in. (56.35 mm)**.
5. Move the tool to the corner of the workpiece or any known position as illustrated in the example.

To preset the tool offset:

6. Press the axis key for the X-axis.

7. Press

8. Move the tool to the Z-axis reference point.

To store this reference point:

9. Press the axis key for the Z-axis.

10. Press

The offset for tool number 1 is preset.

Tool Offset Key (900, Lathe Mode Only) (Continued)

11. Repeat these procedures by touching each tool on the same reference point on the workpiece.

If you do not require tool offset for a tool:

12. Press   

The DRO displays the following in the message window:

TOOL 00

Recall Tool Offset

Recall Tool Offset allows you to recall a previously set tool offset (Range: 1 through 99).

Example: To recall the preset tool offset for tool number 18:

1. Press   

While the tool is activated, the DRO displays the following in the message window:

TOOL 18

Tool Offset Key (900, Lathe Mode Only) (Continued)

Modify Tool Offset – F 35

Modify Tool Offset (**F 35**) allows you to modify the Z-axis tool-offset value for all tools without reentering values. If you place a new part with a different length in the chuck, you must modify all the Z-axis tool offsets in the tool table. .

NOTE: To modify the tool offset, a tool number must be activated.

Example: To modify the Z offset to **.25 in. (6.35 mm)**:



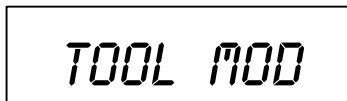

1. Press   

The DRO displays the following in the message window:



TOOL MOD

2. Press the axis key for the Z-axis.

3. Press    

to activate the feature.

Tool Offset Key (900, Lathe Mode Only) (Continued)

Clear Tool Offset – F 32

Clear Tool Offset (F 32) allows you to clear all preset tool offset values (99 tools) before entering new information.

To clear all preset tool offset values:

1. Press   

The DRO displays the following in the message window:



DEL TOOL

When the DRO resets the message window and axis displays, all preset tool offset values are cleared from memory.



Axis Coupling (900, 3-/4-Axis Only) – F 18/F 19

F 18 and/or **F 19** allow you to sum 2 parallel axes on 1 axis display. This allows you to move the coupled axes independently while the DRO automatically calculates the true tool position. The following table lists which axes are summed by **F 18** and **F 19** for a 3-axis DRO and a 4-axis DRO.

| | 3-Axis DRO | 4-Axis DRO |
|-------------|-----------------|-----------------|
| F 18 | Axis 2 + Axis 3 | Axis 3 + Axis 4 |
| F 19 | N/A | Axis 1 + Axis 2 |

The DRO displays the summed axes in the message window.

Example: For a 4-axis 900 DRO set to Lathe Mode with axis designations **X**, **X₁**, **Z**, and **Z₁**:

1. Press    to set coupling of axis 3 and axis 4.

The DRO temporarily displays the following in the message window:



COUP ON

The DRO clears the **COUP ON** message and displays the following in the message window.

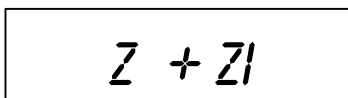

Z + Z₁

indicating the summed axes.

2. Press    to set coupling of axis 1 and axis 2.

Axis Coupling

(900, 3-1/4-Axis Only) – F 18/F 19 (Continued)

The DRO temporarily displays the following in the message window:



COUP ON

The DRO clears the **COUP ON** message and displays the following in the message window.

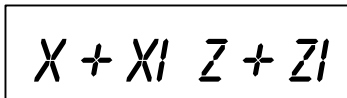

X + XI Z + ZI



indicating the summed axes.

To turn off axis coupling axis 3 and axis 4:

1. Press   

AND/OR

To turn off axis coupling axis 1 and axis 2:

2. Press   

The DRO temporarily displays the following in the message window:

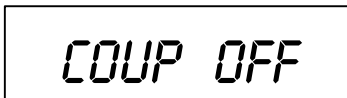

COUP OFF

Electronic Notepad

The Electronic Notepad allows you to program information into the DRO memory. You can program a maximum of 500 lines. Each line contains the desired position, which datum point it refers to (Mill Mode) or which tool (Lathe Mode), and whether the move is in Absolute or Incremental Mode. One line also can contain an entire preprogrammed hole pattern. You can store separate programs consecutively.

You can store the program directly by entering the data for desired positions or you can generate it through a teach-In process. Teach-In allows you to store the program while you perform the moves and operations to make the first part. When you recall the programmed information the DRO sets ABS or INCR, prompts for Datum or Tool, and displays the axis dimensions as a distance-to-go.

The Electronic Notepad retains the entered information, even after you turn off the power, for as long as 10 years.

You can enter the following information into the Electronic Notepad:

- ❑ ABSolute or INCRemental Mode
- ❑ Datums (Mill Mode) or Tools (Lathe Mode)
- ❑ Axis Dimensions
- ❑ Circular-Hole Patterns
- ❑ Linear-Hole/Frame-Hole Patterns

To enter information into the Electronic Notepad:

1. Press 

The DRO displays the following in the message window:



ENTER PROG

Electronic Notepad (Continued)

Entering Axis Dimensions

To enter axis dimensions into the Electronic Notepad:

2. Press  to select the Absolute or Incremental Mode.



NOTE: In all cases, set the first line of a program to ABS (Absolute) Mode.

If required, you can specify a new Datum (Mill Mode) or Tool (Lathe Mode) – for example, Datum 1:

3. Press   

Example: To program dimensions (10, 5.1, and 5) for axes 1 through 3 respectively:

4. Press axis key 1.

5. Press  

6. Press axis key 2.

7. Press   

8. Press axis key 3.

9. Press 

10. Press 

Electronic Notepad (Continued)

The DRO displays the following in the message window:

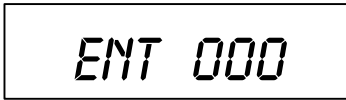

ENT 000

indicating memory location
000.

The DRO, by default, indicates the first empty memory location as the first line of a new program.

To store the entered axis dimensions into line 000:

11. Press 

OR

To start the program in a different memory location – for example, line **026**:

Press   

The DRO displays the following in the message window:



ENTER PROG

NOTE: Always note the first memory location for a new program. This is the location you specify later when you need to recall the program.

12. Repeat steps 2 through 11 to enter additional axis dimensions.

NOTE: The DRO indicates memory locations consecutively.

Electronic Notepad (Continued)

To exit Axis Dimension Entry:



13. Press

NOTE: When you exit, the DRO automatically stores a **PRG END** in the first memory location after the last line. This allows you to exit the axis dimension entry mode, before you finish the program and return later to complete the program by specifying one less than the memory location prompted by the DRO.

Electronic Notepad (Continued)

Entering Axis Dimensions by Teach-In

As an alternative to manually entering the axis dimensions, you can store the program the first time you machine the workpiece.

1. Make sure you properly zero the DRO or set the datum for the starting position.
2. Perform the steps described in **Entering Axis Dimensions** except when the DRO instructs you to enter an axis dimension, move the table to the desired location on the workpiece.

The axis displays will indicate the axis dimension values.

To automatically enter the values into the Electronic Notepad:

3. Press 

The DRO prompts for the correct memory location in the message window.

4. Make sure this is the correct location or change it.

To store the values into the Electronic Notepad:

5. Press 

Electronic Notepad (Continued)

Entering Bolt-Hole/Linear-Hole Patterns

The DRO allows you to store a bolt-hole or linear-hole pattern on one line in the Electronic Notepad (only in Absolute Mode).

NOTE: To use a bolt-hole or linear/frame-hole pattern in the Electronic Notepad, you must first program the hole pattern using the Advanced Functions, Bolt-Hole Pattern function.

If you are not already in the enter program mode:

1. Press  to enter information into the Electronic Notepad:

The DRO displays the following in the message window:



ENTER PROG

To enter a hole pattern into the Electronic Notepad:

2. Press 

The DRO displays one of the following in the message window:

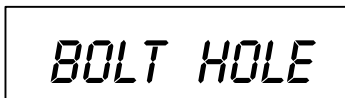

BOLT HOLE

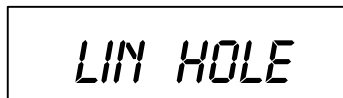

LIN HOLE

3. Press  to toggle between bolt-hole pattern and linear-hole pattern.

Electronic Notepad (Continued)

4. Press  to select the desired type of hole pattern.

The DRO displays one of the following in the message window:

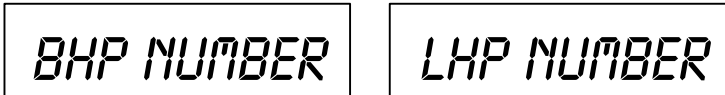

To enter the desired pattern number – for example, BHP number 1:

5. Press 

The DRO prompts for the memory location in the message window:

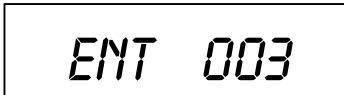

NOTE: If necessary, change the specified memory location by entering the desired location.

To store the pattern:

6. Press 

The DRO stores bolt-hole pattern number 1 in line 3 of the Electronic Notepad.

Electronic Notepad (Continued)

Recalling Dimensions

The DRO allows you to recall programmed information from the Electronic Notepad. You must know the memory location for the first line in the program you want to recall.

NOTE: Before you recall information from the Electronic Notepad, establish a machine home position using [Absolute Zero Set – F 01](#) or activate [EverTrack™ Mode – F 02](#).

To recall information from the Electronic Notepad:

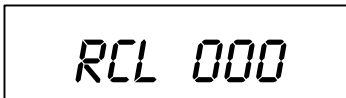

1. Press  to activate the feature.

The DRO displays the following memory location in the message window:



RCL 000

To specify a program – for example, memory location **036**:

2. Press   

The DRO displays one of the following in the message window:

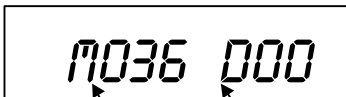

M036 000

Line Number

Datum Point
(Mill Mode)

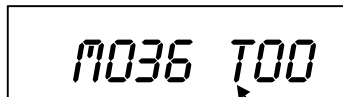

M036 T00

Tool Number
(Lathe Mode)

NOTE: If the **D** (Mill Mode) or **T** (Lathe Mode) is blinking, you must reset the specified datum or tool number. Press the Datum/Tool Offset key and enter the correct number. The blinking stops when the correct datum or tool number has been reset.

Electronic Notepad (Continued)

The values displayed on the axis displays indicate the distance to the programmed position.

3. Move the machine axis until the displays indicate zero.

This is the first position stored in the Electronic Notepad.

4. Press   to recall the next line in the Electronic Notepad.

The DRO displays the following in the message window:



RCL 001

When the DRO has displayed the last program line in the Electronic Notepad and the next line is recalled, the DRO displays the following in the message window:

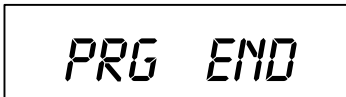

PRG END

To recall a specific line of information from the Electronic Notepad – for example, line **001**:

5. Press 

6. Press   

7. Press 

Electronic Notepad (Continued)

To exit the recall feature:

8. Press 

Electronic Notepad (Continued)

Clearing the Electronic Notepad

You can clear all 500 lines (including bolt-hole and linear-hole patterns) from the Electronic Notepad before you enter new information.

To clear information from the Electronic Notepad:

1. Press   

The DRO momentarily displays the following in the message window:

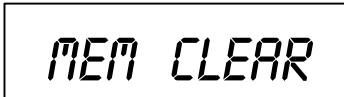

MEM CLEAR

The DRO clears the message window, axis displays, and all 500 Electronic Notepad lines.

Inserting/Deleting a Line

You can insert a line of information in the Electronic Notepad or delete a line of information from the Electronic Notepad.

To insert or delete a line from the Electronic Notepad:

1. Press  for approximately 2 seconds.

The DRO displays one of the following in the message window:

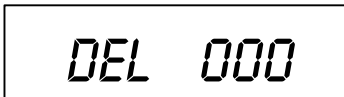

DEL 000

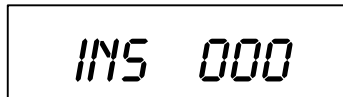

INS 000

2. Press  to toggle between Delete and Insert.

Electronic Notepad (Continued)

To insert/delete a line to/from the Electronic Notepad – for example, line **003**:

3. Press   

4. Press 

If you selected Delete, the DRO deletes the line from the Electronic Notepad.

If you selected insert, you can program a line on the new line number in the Electronic Notepad.

Select Axis for Recall – F 63

F 63 allows you to specify which axis dimensions the DRO recalls from the Electronic Notepad when you press the **RCL** key. You can recall dimensions for all axes or for one or more specific axes.

To select axis dimensions for recall:

1. Press   

The DRO displays the following in the message window and axis displays:

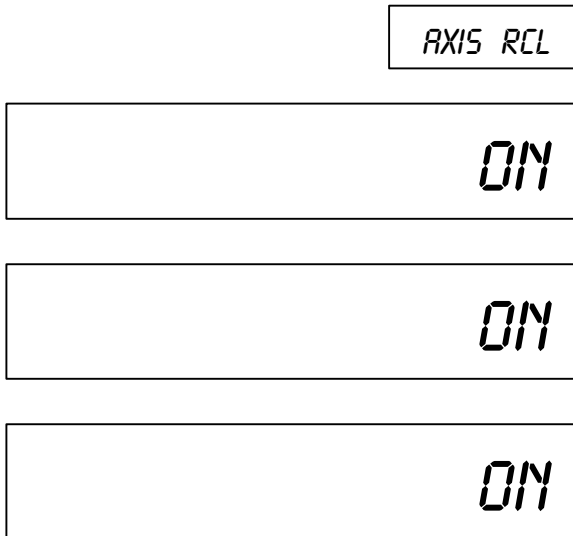

2. Press the desired axis key(s) to toggle the axis recall ON or OFF.

3. Press 

The DRO will update only the axis dimensions set to ON when you recall from the Electronic Notepad.

Mirror Image – F 17

After you enter dimensions in the Electronic Notepad, **F 17** allows you to reverse or mirror all positions on the X-axis and/or Y-axis without re-entering the positions.

Example 1: To set the X-axis as a mirror image:

1. Press   

The DRO displays the following in the message window:



NO MIRROR

2. Press axis key 1.

The DRO displays the following in the message window:



MIRROR X

3. Press 

Example 2: To set the X-axis and Y-axis as a mirror image:

1. Press   

The DRO displays the following in the message window:



NO MIRROR

Mirror Image – F 17 (Continued)

2. Press axis key 1.

The DRO displays the following in the message window:



MIRROR X

3. Press axis key 2.

The DRO displays the following in the message window:



MIRROR XY

4. Press



NOTE: When you recall a program with mirror image activated, the DRO displays a blinking **M** on the left side of the message window.

Output Connections (With I/O Option Only)

Output connections are located on the back of the DRO. When DRO functions are activated, the DRO generates signals through these connections to operate external devices.

Each output can sink 500 mA of current when active. The output load of Relay 1 and Relay 2 should be a maximum of 10 VA (maximum 20 Volts, 0.75 A).

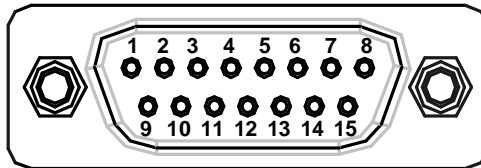

DA 15 Connector (Male)

| | | | |
|-------|------------------------------|--------|--|
| Pin 1 | Relay 1 Output | Pin 9 | Relay 2 Output |
| Pin 2 | Relay 1 Output | Pin 10 | Approaching Zero |
| Pin 3 | X-Axis Zero | Pin 11 | Y-Axis Zero |
| Pin 4 | Z-Axis Zero | Pin 12 | Relay 2 Output |
| Pin 5 | W-Axis Zero | Pin 13 | Ground |
| Pin 6 | Ground | Pin 14 | +24 Volts |
| Pin 7 | +24 Volts | Pin 15 | DAC Output for CSS |
| Pin 8 | Analog Ground for DAC Output | | (0-10 Volt/10mA, 12 Bit, galv. isolated) |

The output connections, X-axis zero, Y-axis zero, Z-axis zero, W-axis zero, and approaching zero are enabled by applying a constant +24 VDC, 50 mA source to pin 7 and pin 14 and a ground to any of two ground pins.

When outputs are enabled, pin 3, pin 4, pin 5, and pin 11 generate a 24-V common signal as the corresponding axis value is zero. Pin 10 generates a 24-V common signal within a set range of an axis zero. The 24-V common output is generally used to complete a relay control circuit.

Input Connections (With I/O Option Only)

Input connections are located on the back of the DRO. These connections allow signals from external devices to activate specific DRO functions.

DRO functions are activated by applying a +24 VDC, 10 mA signal for a minimum of 100 ms. Inputs to the DRO are optically coupled for protection. The Ground pin is the reference ground for the inputs and should always be used.

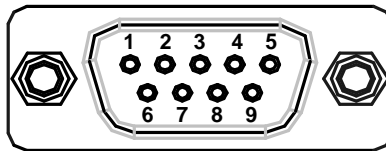



DE 9 Connector (Male)

| | |
|-------|--|
| Pin 1 | X-Axis Zero |
| Pin 2 | Z-Axis Zero |
| Pin 3 | Recall (RCL Key for remote operations) |
| Pin 4 | First-Spark Detection (900E Only) |
| Pin 5 | Ground |
| Pin 6 | Y-Axis Zero |
| Pin 7 | Store (ENT Key for remote operations) |
| Pin 8 | Print |
| Pin 9 | W-Axis Zero |

Zero Output ON/OFF (With I/O Option Only) – F 33

F 33 allows you to toggle the zero output ON or OFF. (Default: OFF)

To turn the zero output ON:

1. Press   

The DRO displays the zero output setting in each axis display and the following in the message window:

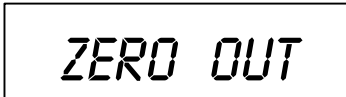

ZERO OUT

2. Press the desired axis key

to toggle the zero output setting ON or OFF.

3. Press 

to activate the setting.

Approaching Zero Output Axis Select (900 With I/O Option Only) – F 14

F 14 allows you to specify which axis the DRO will use for approaching zero (APZ) output. When the selected axis is within the range preset using [Approaching Zero Range – F 07](#), the DRO turns on the output.

To specify the axis for APZ output:

1. Press   

The DRO displays the following in the message window:

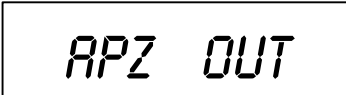

APZ OUT

NOTE: You can select only one axis for APZ output.

2. Press the desired axis key to toggle the axis ON.

The DRO displays the following in the selected axis display:



On

To exit without specifying the axis for APZ output:

3. Press 

To set the axis for APZ output:

4. Press 

Zero Output Time Select (With I/O Option Only) – F 25

F 25 allows you to specify the time for which a remote device is turned on when the selected axis crosses zero. (Default: 100 ms) [Zero Output – F 33](#) must be ON.

To change the setting:

1. Press    to select the feature.

The DRO displays the following in the message window:

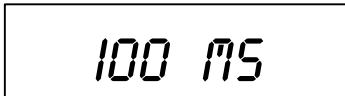

100 MS

The DRO displays the last-entered setting in the message window.

The available settings are:

Zero Output Time Settings

30 ms, 100 ms (default), 200 ms, 300 ms,
400 ms, 500 ms, 600 ms, 700 ms, 800 ms,
900 ms, and 1 second

RS-232 Interface (With I/O Option Only)

The RS-232 Interface connection is located on the back of the DRO. This connection allows you to exchange data with other RS-232 devices.

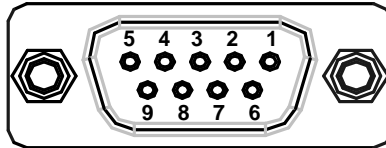

DE 9 Connector (Female)

| | |
|-------|------------------------------|
| Pin 1 | Not Used |
| Pin 2 | TxD (Transmit Data) |
| Pin 3 | RxD (Receive Data) |
| Pin 4 | Not Used |
| Pin 5 | Ground |
| Pin 6 | Not Used |
| Pin 7 | CTS (Clear-To-Send) |
| Pin 8 | RTS (Request-To-Send) |
| Pin 9 | Not Used |



NOTE: Clear-To-Send (**CTS**) and Request-To-Send (**RTS**) are connected but have no function.

RS-232 Setup (With I/O Option Only) – F 27

F 27 allows you to set up the following parameters for the RS-232 port:

- Baud Rate
- Parity
- Data Bits
- Printer or Computer Output

To set up RS-232 port parameters:

1. Press   

The DRO displays the following in the message window:

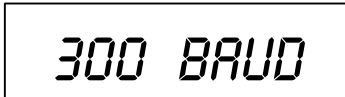

300 BAUD

The available baud rates are:

RS-232 Baud Rates

300 (default), 600, 1200, 2400,
4800, 9600, 19200, 38400

RS-232 Setup

(With I/O Option Only) – F 27 (Continued)

The available selections are:

- NO PARITY (default)
- EVEN PARITY
- ODD PARITY

4. Press



repeatedly to scroll through the options.

5. Press



to set the parity.

The DRO displays the following in the message window:



The available selections are:

- 8 Data Bit (default)
- 7 Data Bit

NOTE: If you selected **NO PARITY**, you can only select **8 DATA-BIT**.

6. Press



repeatedly to scroll through the options.

7. Press



to set the data bits.

RS-232 Setup

(With I/O Option Only) – F 27 (Continued)

The DRO displays one of the following in the message window:

PRINTER

COMPUTER

The available selections are::

- PRINTER** (default) Each output of a string ends with a Carriage Return (CR) and a Line Feed (LF).
- COMPUTER** Each output of a string ends with a Carriage Return (CR).

8. Press  to toggle between the options.

9. Press  to set the output.

OR

10. Press  to exit without change.

RS-232 ON/OFF (With I/O Option Only) – F 28

F 28 allows you to toggle the RS-232 port ON or OFF. (Default: OFF)

To toggle the RS-232 port ON:

1. Press **F** **2** **8**

The DRO displays the following in the message window:

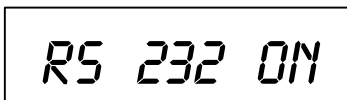

RS 232 ON

To toggle the RS-232 port OFF:

1. Press **F** **2** **8**

The DRO displays the following in the message window:



RS 232 OFF

Printing Axis Values (With I/O Option Only)

NOTE: Before sending data to the printer, ensure that the DRO is not in the Preset Mode.

To print axis values to a printer:

1. Press  to print the data from axis 1.
2. Press  to print the data from axis 2.
3. Press  to print the data from axis 3.
4. Press  to print the data from axis 4.
5. Press  to print the data from all axes.

Printed Axis Value Format

The DRO prints the axis values in the following format:

Axis value unit of measurement counting mode diameter mode

Examples:

| | | | | | |
|---|------------|-----|-----|---|------------------------|
| X | -123.456 | mm | ABS | D | |
| Y | 454.902 | in | INC | | |
| W | -235.12.30 | dms | | | (dms = degree-min-sec) |

Remote Operation (With I/O Option Only)

You can remotely operate the DRO from an IBM-compatible computer running a terminal program via the RS-232 Interface connection. The baud rate, parity, and data bit settings of the DRO and the terminal (or computer) must agree, and RS-232 must be ON. After you activate the RS-232 link, you can operate the DRO by pressing the computer keyboard.

| DRO Keypad | Computer Keyboard Equivalent | DRO Keypad | Computer Keyboard Equivalent | DRO Keypad | Computer Keyboard Equivalent |
|------------|------------------------------|---------------|------------------------------|----------------|------------------------------|
| Axis Key 1 | X | | T | | 4 |
| Axis Key 2 | Y | | C | | 5 |
| Axis Key 3 | Z | | I | | 6 |
| Axis Key 4 | W | | M | | 7 |
| | S | | - | | 8 |
| | E | | . | | 9 |
| | R | | 0 | Reset all Axes | P |
| | F | | 1 | XON | J |
| | D | | 2 | XOFF | N |
| | A | | 3 | | |
| | G90 | | G91 | | |
| (Absolute) | | (Incremental) | | | |
| | G70 | | G71 | | |
| (Inch) | | (Metric) | | | |

Send Program to External Device (With I/O Option Only) – F 60

F 60 allows you to send a program to an external device (such as a PC or disk drive) using the RS-232 port.

NOTE: The RS-232 port must be toggled ON using [RS-232 ON/OFF – F 28](#).

To send a program to an external device:

1. Press F 6 0

The DRO displays the following in the message window:

SEND PROG

Example: Output Format

```

*
001 00 A N N +00001.000 -00001.000 +00002.000 -00005.000
002 01 I N N +00010.500 -00030.880 +00062.440 -00020.500
003 01 A N N +00030.000 -00020.200 -00005.020 +00030.000
004 00 A 2 N
005 00 A N 1
  
```

| | | |
|--------------|----------------------------------|---------------------------------|
| * | | (Hex 2A) |
| 001 | Beginning of Program | |
| 00 | Line Number | 3 Characters – 000-500 |
| 00 | Tool (Lathe)/Datum (Mill) Number | 2 Characters – 00-99 |
| A | Absolute/Incremental Mode | 1 Character – A or I |
| N | Number of Bolt-Hole Pattern | 1 Character – 0-9 or N |
| N | Number of Linear-Hole Pattern | 1 Character – 0-9 or N (No) |
| Axis Value 1 | | ±, 10 Characters, Decimal Point |
| Axis Value 2 | | ±, 10 Characters, Decimal Point |
| Axis Value 3 | (3-axis DRO Only) | ±, 10 Characters, Decimal Point |
| Axis Value 4 | (4-axis DRO Only) | ±, 10 Characters, Decimal Point |
| * | End of Program | (Hex 2A) |

Terminate every output line with LF (line feed).

Separate every data block in a line with a Space (Hex 20).

Recall Program from External Device (With I/O Option Only) – F 61

F 61 allows you to recall a program from an external device (such as a PC or disk drive) using the RS-232 port.

NOTE: The RS-232 port must be toggled ON using [RS-232 ON/OFF – F 28](#).

To recall a program from an external device:

1. Press   

The DRO displays the following in the message window:

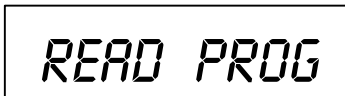

READ PROG

Print Program to External Printer (With I/O Option Only) – F 62

F 62 allows you to print a program to an external printer or PC using the RS-232 port.

NOTE: The RS-232 port must be toggled ON using [RS-232 ON/OFF – F 28](#).

To print a program to an external device:

1. Press   

The DRO displays the following in the message window:



PRINT PROG

Relay 1/Relay 2 Setup (900 With I/O Option Only) – F 38/F 39

F 38 and **F 39** allow you to set up the parameters for Relay 1 and Relay 2.

The following procedures for setting up parameters for Relay 1 also can be used to set up parameters for Relay 2. Substitute **F 39** to set up Relay 2.

To set up Relay 1:

1. Press **F** **3** **8**

The DRO displays the following in the message window:

RELAY1 OFF

2. Press **±** to toggle Relay 1 ON.

3. Press **SET**

The DRO displays the following in the message window:

CONT CLOSE

4. Press **±** to toggle contact OPEN.

5. Press **SET**

The DRO displays the following in the message window:

DIR SIGNAL

Relay 1/Relay 2 Setup (900 With I/O Option Only) – F 38/F 39 (Continued)

6. Press  to toggle between Direct Signal and Coincidence Pulse.

7. Press 

If you select Coincidence Pulse, you can change the output time. The available output times for Coincidence Pulse are:

Coincidence Pulse Output Time

100 ms (default), 500 ms, 1 sec,
2 sec, 3 sec, 4 sec, 5 sec, 10 sec,
30 sec, 1 min, 2 min, 5 min, 10 min

8. Press  repeatedly to scroll through the options.

9. Press  to select the Coincidence Pulse output time.

The DRO displays the following in the message window:

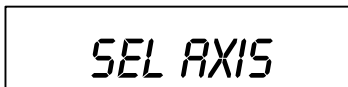

Relay 1/Relay 2 Setup (900 With I/O Option Only) – F 38/F 39 (Continued)

10. Press the desired axis key.

11. Press **5** **.** **2** **0** **SET** to enter the value for the switch off point.

NOTE: You can assign each relay to each axis.

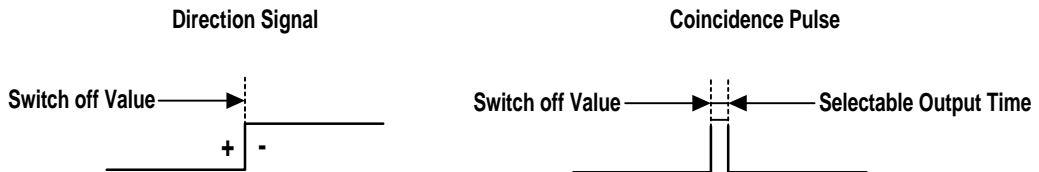

Output Test (With I/O Option Only) – F 42

F 42 allows you to test the following available DRO outputs:

- X ZERO OUT
- Y ZERO OUT
- Z ZERO OUT
- W ZERO OUT
- APZ OUT
- RELAY 1
- RELAY 2

If any of these tests fail, contact your local distributor or ANILAM Customer Services.

To start the output tests:

1. Press   

The DRO turns on each available output for approximately 1 second. The message window displays the name of each output test and the beeper sounds a short beep when each test is complete.

To return to normal operation:

2. Press 

Constant Surface Speed (CSS) Setup (900 With CSS and I/O Options)

If your DRO has the CSS option, you can use the DAC (Digital/Analog Converter) output voltage to control the spindle speed. You can vary the DAC output voltage between 0V and 10V with 12-bit resolution. A maximum of 5 different gears can be set up.

Use the following F-codes to set up the CSS feature:

[F 96](#) [DAC Output Voltage Setup](#)

[F 97](#) [DAC Output Voltage Offset Adjustment](#)

[F 98](#) [DAC Output Voltage Test](#)

DAC Output Voltage Setup (900 With CSS and I/O Options) – F 96

F 96 allows you to set up the DAC output voltage.

To set up the CSS feature:

1. Press **F** **9** **6** to select DAC voltage setup.

The DRO displays the following in the message window:

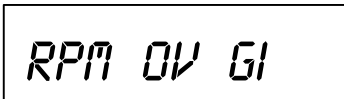

RPM 0V G1

prompting for the spindle speed at 0V for Gear 1.

To enter the spindle speed at 0V for Gear 1 (For example, 0 RPM):

2. Press **0** **SET**

The DRO displays the following in the message window:



RPM 10V G1

prompting for the spindle speed at 10V for Gear 1.

To enter the spindle speed at 10V for Gear 1 (For example, 2000 RPM):

3. Press **2** **0** **0** **0** **SET**

4. Repeat steps 1 through 3 for each existing gear range (maximum 5).

NOTE: Spindle speed refers to the speed of the spindle, not the spindle motor.

DAC Output Voltage Offset Adjustment (900 With CSS and I/O Options) – F 97

F 97 allows you to adjust the DAC output voltage offset. You will require a digital multimeter to perform this feature.

To set up the CSS feature:

1. Connect a multimeter to Pin 15 and Pin 8 and measure the DAC output voltage.

2. Press   

The DRO displays the following in the message window:

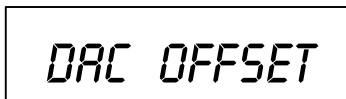

DAC OFFSET



The DRO displays a value between 0 and 50 in the axis display. To change the output voltage, change this value.

To adjust the DAC offset to exactly 0mV:

3. Press 

repeatedly until the multimeter indicates 0 mV.

To reverse the scrolling direction:

4. Press  

To enter the adjusted DAC output voltage:

5. Press 

DAC Output Voltage Test (900 With CSS and I/O Options) – F 98

F 98 allows you to verify the DAC output voltage setting.

To verify DAC output voltage setting:

1. Connect a multimeter between Pin 15 and Pin 8 and measure the DAC output voltage.

2. Press   

The DRO displays the following in the message window:

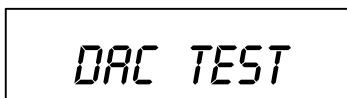

DAC TEST

3. Press  to display 0V on the axis display.

4. Press  to display 5V on the axis display.

5. Press  to display 10V on the axis display.

NOTE: The displayed DAC output voltage must be within 100mV of the nominal values.

Constant Surface Speed (CSS)/Direct RPM Operation (900 With CSS and I/O Options)

If your DRO has the CSS option, you can use the DAC (Digital/Analog Converter) output voltage to control the spindle speed. You can use this feature in Lathe Mode to obtain a constant surface speed as the tool changes the workpiece diameter.

Use the following F-codes to operate the CSS feature:

[F 48](#) [CSS/Direct RPM Input](#)

[F 50](#) [DAC Output Voltage On/Off](#)

NOTE: The CSS feature must be set up properly.

NOTE: Do not start the spindle with the DRO (For example, using **F 50**). The machine should have a separate switch for this purpose.

CSS/Direct RPM Input

(900 With CSS and I/O Options) – F 48

F 48 allows you to specify the desired Constant Surface Speed (CSS), which is entered in Feet per Minute (**INCH Mode**) or Meters per Minute (**MM Mode**). The DRO maintains the specified constant surface speed as the diameter of the workpiece changes. You can specify a maximum spindle speed (**MAX SPEED**) to restrict the spindle speed from exceeding this speed as the diameter decreases, or a specific spindle speed (**DIRECT RPM**) to maintain the spindle speed at a constant RPM.

To program a CSS operation:

1. Select a tool by using the Tool Offset.

2. Press



The DRO displays the following in the message window:

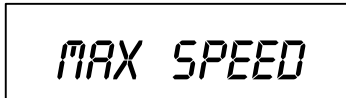

NOTE: You can limit the spindle speed to either the top speed (preset spindle speed at maximum DAC output voltage) or the specified maximum speed (MAX SPEED), whichever is lower.

To limit the spindle speed (For example, to **2500 RPM**):

3. Press



NOTE: The decimal point at the left of the X-axis display will blink if the spindle speed is limited by MAX SPEED.

CSS/Direct RPM Input

(900 With CSS and I/O Options) – F 48 (Continued)

The DRO displays one of the following in the message window (depending on the number of available gears):

GEAR 1

GEAR 2

4. Press



to toggle and select the desired gear.

The DRO displays one of the following in the message window:

CSS ON

DIRECT RPM

The available selections are:

- CSS ON** Activates the CSS feature. The DRO varies the spindle speed to maintain a constant surface speed as the workpiece diameter changes.
- DIRECT RPM** The DRO maintains the spindle speed at a constant RPM.

5. Press



to toggle between the settings and to set the feature.

If you select **CSS ON**, the DRO displays the following in the message window:

CS--SPEED

CSS/Direct RPM Input

(900 With CSS and I/O Options) – F 48 (Continued)

The X-axis display indicates the previously used surface speed. The X designation is blinking, indicating you can enter a value.

If the displayed surface speed is acceptable:

6. Press  to continue.

OR

To set a new surface speed (For example, **200** RPM):

7. Press     to set the surface speed.

NOTE: Surface speed must be entered in Feet per Minute when the DRO is set to **INCH** Mode or Meters per Minute when the DRO is set to **MM** Mode.

If you select **DIRECT RPM**, the DRO displays the following in the message window:

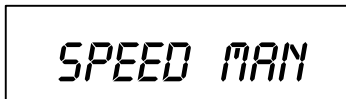

prompting for the desired spindle speed.

To set the spindle speed (For example, **2500** RPM):

8. Press      to set the spindle speed.

DAC Output Voltage ON/OFF (900 With CSS and I/O Options) – F 50

F 50 allows you to turn the DAC output voltage ON or OFF:

To turn the DAC output voltage **ON** or **OFF**:

1. Press   

The DRO displays one of the following in the message window:

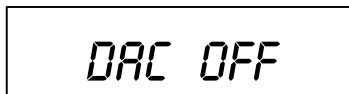

DAC OFF

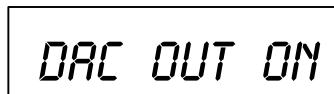

DAC OUT ON

2. Press  

to turn the DAC output
voltage **ON** or **OFF**.

NOTE: Do not turn the spindle **ON** or **OFF** using **F 50**. The machine should have a separate switch for this purpose.

Parameter Setting for Spindle Speed Display (2-Axis and 3-Axis, With SSD Option Only)

If your DRO has the SSD Option, it includes a separate display in addition to the regular axis displays. For example, a 2-axis DRO with the SSD Option has 3 axis displays. The extra display (at the bottom of the DRO) indicates the spindle speed in revolutions per minute (RPM). The machine spindle must be fitted with a rotary encoder. The DRO back panel includes an additional encoder input connector to connect the rotary encoder.

You must set up the spindle speed display axis parameters for the rotary encoder using [Parameter Settings - F 20](#).

To enter parameters for spindle speed display (SSD):

1. Press    to select the feature.

The DRO displays the following in the message window:



PARAMETER

2. Press the bottom Axis Key to select the SSD display.

The DRO displays the following in the message window and in the SSD display:

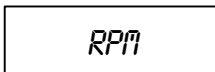

RPM



RPM

3. Press 

Parameter Setting for SSD (2-Axis and 3-Axis, With SSD Option Only) (Continued)

The DRO displays the following in the message window and in the SSD display:

LINE COUNT



indicating the default line count.

To enter the line count for the rotary encoder – for example, **1500** lines:

4. Press

5. Press

to set the line count and exit.

EDM Features (900E Only)

The Wizard 900E is a high-performance programmable DRO designed for EDM applications. The 900E includes the I/O Option as standard.

NOTE: The Z-axis (Axis 3) must be used as the spark erosion axis for the EDM functions to work correctly.

The 900E includes the following EDM features:

- ❑ [EDM Mode \(Three Z-Axis Display Mode\)](#)
- ❑ [First Spark Detection Setup](#)
- ❑ [Z-Depth Guard](#)
- ❑ [Spark Out](#)
- ❑ [SparkArrest™](#)

EDM Mode allows you to change the display mode for axis displays 1, 2, and 3 to display three different Z-axis values during the sparking cycle. When you activate EDM Mode, the DRO turns off the X and Y designations and turns on the leftmost decimal point for each axis. The following table lists what each axis displays in Normal Mode and EDM Mode.

| | Normal Mode | EDM Mode |
|---------------|--------------------|-------------------|
| Axis 1 | Actual X-Position | Z-Depth to Go |
| Axis 2 | Actual Y-Position | Target Z-Depth |
| Axis 3 | Actual Z-Position | Actual Z-Position |

EDM Features (900E Only) (Continued)

For Example: The DRO is in EDM Mode and the axis displays indicate the following:

. 1.415

Remaining distance to Target
Depth

. 5.200

Desired Z-Depth

Z 3.785

Actual position relative to the zero
position

EDM Features (900E Only) (Continued)

First Spark Detection Setup allows you to define how you activate the EDM Mode. It can be either manually activated or automatically activated if the DRO receives a signal from a first spark detector. The position at which the first spark occurs is the Zero position.

Z-Depth Guard allows you to track the depth of the erosion relative to the Zero position. A relay will switch when the desired Z-depth is reached, to terminate the main sparking cycle.

Spark Out allows you to specify an additional sparking cycle that allows sparking to continue for a selectable period of time in order to obtain a quality finish.

SparkArrest™ is a safety feature that allows you to set a limiting distance above the workpiece over which the DRO disables sparking. This can be used to avoid sparking if the electrode should move in the wrong direction during the sparking cycle, well before the electrode has moved out of the electrolyte.

You can set up the EDM features using the following F-codes:

- [First Spark Detection Setup – F 46](#)
- [Relay 1 \(Z-Depth Guard\) – F 38](#)
- [Relay 2 \(Spark Out/SparkArrest™\) Setup – F 39](#)

Relay 1 is used to limit the movement of the Z-axis when the target Z-Depth is reached. Relay 2 is used to turn off sparking, either after a preset Spark-Out time or if the electrode rises over the SparkArrest™ limit.

You can enter the parameters for the sparking cycle using the following F-code:

- [Entering Target Z-depth and Spark-Out time – F 37](#)

[Figure 6](#) illustrates the terms used in the following setup procedures for the EDM features.

EDM Features (900E Only) (Continued)

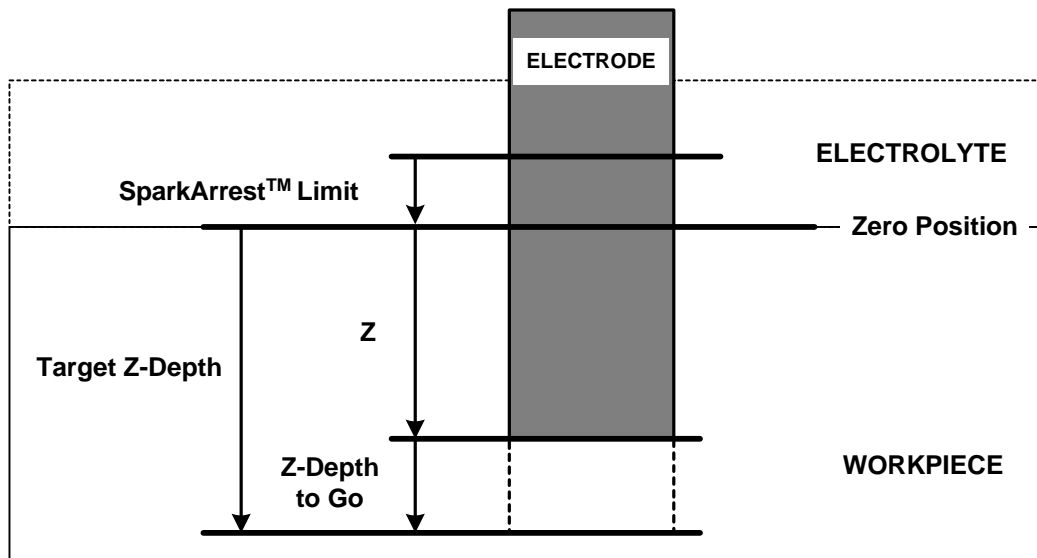

Figure 6: EDM Setup

First Spark Detection Setup (900E Only) – F 46

F 46 allows you to define how you activate the EDM Mode. It can be either manually activated or automatically activated if the DRO receives a signal from a first spark detector. The position at which the first spark occurs is the Zero position.

1. Press    to select the feature.

The DRO displays the following in the message window:

SPARK OFF

2. Press  to scroll through the options.

The available options are:

- [SPARK OFF](#) No First Spark Detection
- [SPARK MAN](#) Manual First Spark Detection
- [SPARK AUTO](#) Automatic First Spark Detection

| | SPARK OFF | SPARK MAN | SPARK AUTO |
|------------------------------|------------------|------------------|-------------------|
| First Spark Detection | No | Manual | Automatic |
| EDM Display Mode | Manual | Manual | Automatic |
| Z Depth Guard | Manual | Automatic | Automatic |
| Spark Out | Manual | Automatic | Automatic |
| SparkArrest™ | No | Automatic | Automatic |

NOTE: Automatic first spark detection requires a sensor input.

NOTE: Automatic features require that you set up Relay 1 and Relay 2.

3. Press  to select the desired option.





4. Position the electrode in the desired X and Y positions.

First Spark Detection Setup (900E Only) – F 46

(Continued)

SPARK OFF – No First Spark Detection

NOTE: Lower the electrode until it touches the workpiece or the first spark occurs. This is the zero position.

5. Press the Z-axis key  to zero the axis display.
6. Press  to activate EDM Mode.
 - Axis 1 display now indicates the distance to the target depth.
 - Axis 2 display indicates the target depth.
 - Z-axis display indicates the actual Z-position relative to the zero position.
7. Start the sparking cycle.
8. Press  to toggle between EDM Mode and X-, Y-, and Z-axis display mode.
9. Terminate the sparking cycle when the Axis 1 display indicates zero and the Z-axis display equals the Target Z-Depth displayed in the Axis 2 display.
10. Press  to exit EDM Mode.

First Spark Detection Setup (900E Only) – F 46

(Continued)

SPARK MAN – Manual First Spark Detection

NOTE: You must also set up the desired EDM features using the procedures described in [Relay 1 \(Z-Depth Guard\) Setup – F 38](#) and [Relay 2 \(Spark-Out/SparkArrest™\) Setup – F 39](#).

1. Position the electrode in the desired X and Y positions.

2. Press  to activate EDM Mode.

The DRO displays the following in the message window:

WAIT SPARK

3. Lower the electrode until it touches the workpiece or the first spark occurs. This is the zero position.

4. Press the Z-axis key  to manually activate EDM Mode.

- Axis 1 display now indicates the distance to the target depth.
- Axis 2 display indicates the target depth.
- Z-axis display indicates the actual Z-position relative to the zero position.

5. Start the sparking cycle.

6. Press  to toggle between EDM Mode and X-, Y-, and Z-axis display mode.

When the electrode reaches the Target Z-Depth, Relay 1 will switch. This can be used to terminate the main sparking cycle.

First Spark Detection Setup (900E Only) – F 46

(Continued)

If Spark-Out is activated, Relay 2 switches at the same time as Relay 1. After the countdown of the preset Spark-Out time, Relay 2 will switch again. This can be used to perform a Spark-Out cycle for a specified duration.

If SparkArrest™ is activated and the electrode should move in the wrong direction and reach the SparkArrest™ level, then Relay 2 will switch allowing the EDM machine to turn off the sparking cycle for safety reasons. The DRO also disables Spark-Out if Relay 2 switches because the electrode reaches the SparkArrest™ level.

When the cycle is finished, you can repeat the same cycle again.

To repeat the cycle:

7. Press the Z-axis key.

To exit EDM Mode:

8. Press



First Spark Detection Setup (900E Only) – F 46

(Continued)

SPARK AUTO – Automatic First Spark Detection

SPARK AUTO Mode requires a First Spark Detection signal from the EDM machine. Refer to [Input Connections \(With I/O Option Only\)](#).

NOTE: You must also set up the desired EDM features using the procedures described in [Relay 1 \(Z-Depth Guard\) Setup – F 38](#) and [Relay 2 \(Spark-Out/SparkArrest™\) Setup – F 39](#).

1. Position the electrode in the desired X and Y positions.

2. Press  to activate EDM Mode.

The DRO displays the following in the message window:

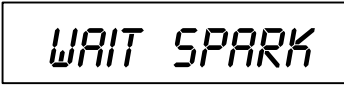

WAIT SPARK

3. Lower the electrode until it touches the workpiece or the first spark occurs.

The DRO automatically activates EDM Mode.

- Axis 1 display now indicates the distance to the target depth.
- Axis 2 display indicates the target depth.
- Z-axis display indicates the actual Z-position relative to the zero position.

4. Start the sparking cycle.

If necessary:

5. Press  to toggle between EDM Mode and X-, Y-, and Z-axis display mode.

First Spark Detection Setup (900E Only) – F 46

(Continued)

When the electrode reaches the Target Z-Depth, Relay 1 will switch. This can be used to terminate the main sparking cycle.

If Spark-Out is activated, Relay 2 switches at the same time as Relay 1. After the countdown of the preset Spark-Out time, Relay 2 will switch again. This can be used to perform a Spark-Out cycle for a specified duration.

If SparkArrest™ is activated and the electrode should move in the wrong direction and reach the SparkArrest™ level, then Relay 2 will switch allowing the EDM machine to turn off the sparking cycle for safety reasons. The DRO also disables Spark-Out if Relay 2 switches because the electrode reaches the SparkArrest™ level.

To exit EDM Mode:

6. Press 

Z-Depth Guard Setup, Relay 1 (900E Only) – F 38

F 38 allows you to set up Relay 1 to control the maximum electrode depth from the zero position (Target Z-Depth).

NOTE: For proper operation of the EDM functions, you must enter Target Z-Depth and Spark-Out time using [Entering Target Z-depth and Spark-Out time – F 37](#).

NOTE: Refer to the instructions provided by the EDM machine builder for the appropriate setup parameters.

To set up Relay 1:

1. Press    to select the feature.

The DRO displays one of the following in the message window:

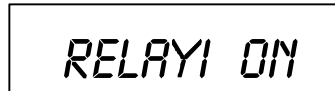
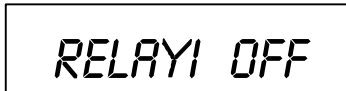

2. Press   to toggle Relay 1 ON and set the feature.

NOTE: Z-Depth Guard is activated only if Relay 1 is ON.

The DRO displays one of the following in the message window:

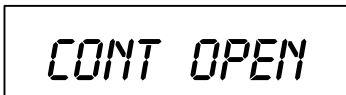

3. Press   to toggle between the settings and to set the feature.

Z-Depth Guard Setup, Relay 1 (900E Only) – F 38

(Continued)

The DRO displays one of the following in the message window:



DIR SIGNAL

COIN PULSE

4. Press  

to toggle between the settings and to set the feature.

If you select **COIN PULSE** (Coincidence Pulse):

5. Press  

to scroll through the settings and set the output time.

Spark-Out/SparkArrest™ Setup, Relay 2 (900E Only) – F 39

F 39 allows you to set up Relay 2 to control the Spark-Out time and SparkArrest™ limit.

NOTE: For proper operation of the EDM functions, you must enter Target Z-Depth and Spark-Out time using [Entering Target Z-depth and Spark-Out time – F 37](#).

NOTE: Refer to the instructions provided by the EDM machine builder for the appropriate setup parameters.

To set up Relay 2:

1. Press    to select the feature.

The DRO displays one of the following in the message window:

RELAY2 OFF

RELAY2 ON

2. Press   to toggle Relay 2 ON and set the feature.

NOTE: Spark-Out and SparkArrest™ are activated only if Relay 2 is ON.

The DRO displays the following in the message window:





S--ARREST

The Z-axis begins to blink prompting for a value.

Spark-Out/SparkArrest™ Setup, Relay 2 (900E Only) – F 39 (Continued)

To set up the SparkArrest™ limit (For example, -1.1):

NOTE: The SparkArrest™ limit is a negative value because it is located above the zero position.

3. Press      to set the SparkArrest™ limit to **-1.1** and exit Relay 2 setup.

The DRO displays one of the following in the message window:

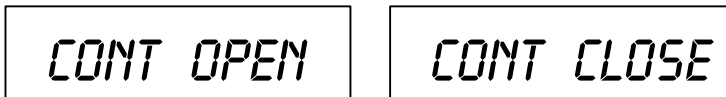

4. Press   to toggle between the settings and set the feature.

The DRO displays one of the following in the message window:

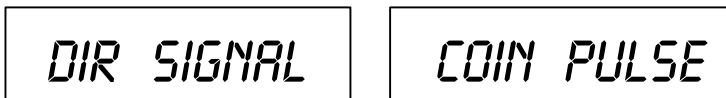

5. Press   to toggle between the settings and set the feature.

If you select **COIN PULSE** (Coincidence Pulse):

6. Press   to scroll through the settings and select the dwell time.

Entering Target Z-Depth and Spark-Out Time (900E Only) – F 37

F 37 is used before a sparking cycle to set up the Target Z-Depth (the maximum electrode depth from the zero position at which the main sparking cycle stops). EDM Mode also allows you to set up the desired time duration for a Spark-Out cycle when you reach the Target Z-Depth. This allows you to obtain a quality finish on the workpiece.

NOTE: You must first set up the desired EDM features using the procedures described in [Relay 1 \(Z-Depth Guard\) Setup – F 38](#) and [Relay 2 \(Spark-Out/SparkArrest™\) Setup – F 39](#). You must also select an EDM Mode option using [First Spark Detection Setup – F 46](#).

To set up the Target Z-Depth:

1. Press    to select the feature.

The DRO displays the following in the message window:



TARGET Z--D

The DRO displays the last-entered Target Z-Depth in the axis display:

If the displayed Target Z-Depth is acceptable:

9. Press  to continue.
OR

To set a new Target Z-Depth (For example, 4.75):

10. Press      to set the Target Z-Depth.

Entering Target Z-Depth and Spark-Out Time (900E Only) – F 37 (Continued)

The DRO displays the following in the message window:

SPARKOUT T

The DRO displays the last-entered Spark-Out time in the axis display:

If the displayed Spark-Out time is acceptable:

11. Press  to exit the feature.
- OR**

To set a new Spark-Out time (For example, 2-hours and 30 minutes):

12. Press      to set the Spark-Out time.

To exit the feature:

13. Press 

The DRO is now prepared for the sparking cycle. Proceed according to the spark detection procedure selected, as described in [First Spark Detection Setup – F 46](#).

Troubleshooting

This section lists problems that could arise with the DRO, and provides possible solutions to correct these problems.

| Symptom | Solution |
|---|--|
| □ Axis display does not illuminate. | <ol style="list-style-type: none">1. Check that the power cord is properly connected and the DRO is turned on.2. Check the AC voltage where the power cord is connected.3. If all of the above are checked and OK, contact your local distributor or ANILAM Customer Services. |
| □ When you move any axis, the displays do not update. | <ol style="list-style-type: none">1. Check that the linear encoders are properly connected.2. Run the system diagnostic tests (F 45).3. If the DRO fails the diagnostics tests, contact your local distributor or ANILAM Customer Services.4. If the DRO passes the diagnostics tests, turn on Linear Encoder Error Check (F 41).5. Move the axis that is not updating.6. If the DRO displays ERROR in the axis display, contact your local distributor or ANILAM Customer Services. |
| □ When you press a key, the beeper does not sound. | <ol style="list-style-type: none">1. Verify that the Beeper (F 21) is enabled.2. If the Beeper is enabled, but still does not sound, contact your local distributor or ANILAM Customer Services. |

Troubleshooting (Continued)

| Symptom | Solution |
|---|---|
| <ul style="list-style-type: none"><li data-bbox="95 354 653 418">❑ When the power is turned OFF, information in memory is lost.<li data-bbox="95 443 653 508">❑ The DRO does not retain the set parameters as they were entered.<li data-bbox="95 532 653 565">❑ Information recalled is incorrect.<li data-bbox="95 589 653 654">❑ The DRO does not respond when you press a key or several keys. | <ol style="list-style-type: none"><li data-bbox="653 345 1232 410">1. Contact your local distributor or ANILAM Customer Services. |

Index

100-point axis error compensation –
F 80/F 81, 24, 39

A

ABS/INCR key, 16
absolute zero set, 23
absolute zero set at reference mark
– F 90, 24
absolute/incremental key, 16
ABSolute/INCRemental key, 2
acknowledging, a keystroke, 11
adding values, 15
adding/subtracting values, 31
ADVanced functions key, 2, 78
approaching zero
– F 06, 49
audio on/off – F 08, 53
indicator, 48
output axis select – F 14, 140
range – F 07, 51
symbol, 50
APZ OUT, 155
APZ output, specify axis, 140
at zero, symbol, 50
audible keyboard tone, 5
automatic first spark detection, 171,
175
avoiding, electrical shock, 54
axis
coupling – F 18/F 19, 120
designation – F 24, 72
displays, 2
error compensation, ON/OFF, 46
keys, 2
reset only – F 16, 21
to measure, 39

B

back panel, Wizard 900, 3
baud rate, 143, 148
beeper, 74, 183
beeper OFF/ON – F 21, 11
beginning angle, 84
blank test, 76
bolt-hole pattern, 78, 80
BT or JB Linear Encoders, 66

C

cables, 6
calculating the taper on a workpiece,
101
centering key, 2, 33
CF feature, 37
CF indicator, 38
changing
direction of travel in parameter
setting, 15
line count and direction of positive
rotation, 67
sign of a preset value, 15
checklist, first-time user, 5
circular-hole patterns, 122
clear
correction factor from memory, 47
datum – F 31, 114
tool offset – F 32, 119
clearing
electronic notepad, 132
preset dimension, 19
coarse resolution symbol, 63, 64, 69
coincidence pulse, 178, 180
coincidence pulse output time
options, 153

- compensation table
 - key functions, description, 44
 - selecting, 41
 - to delete, 45
- computer keyboard equivalent, 148
- computer output, 143
- computer output options, 145
- connecting, the edge sensor probe, 54
- console display, 4
- constant surface speed (CSS), 1, 161
- constant surface speed, setup, 156
- convert inch values to metric values, 13
- correct keystrokes, 11
- correction factor, 37
- correction factor indicator, 38
- correction factor off/on – F 04, 47
- counters test, 75
- course resolution symbol, 68
- CSS ON, 162
- CSS option, 156
- CSS, constant surface speed, 1, 161
- CSS/direct RPM input – F 48, 161
- Czech, 73

D

- DA 15 connector (male), 137
- DAC output voltage
 - ON or OFF – F 50, 164
 - offset adjustment – F 97, 158
 - setup – F 96, 157
 - test – F 98, 159
- data bit settings, 148
- data bits, 143
- data-bit options, 144
- datum, 20
- datum key, 2, 108

- datum, clear – F 31, 114
- datum/tool offset key, 107
- DE 9 connector (female), 142
- DE 9 connector (male), 138
- decimal degree to degree-minutes-seconds conversion, 14
- default
 - line count, 166
 - rotary encoder line count, 67
 - settings, 5
- delete, compensation table, 45
- deleting a line from the electronic notepad, 132
- diagnostics – F 45, 75
- diameter mode, 35
- disclaimer, iii
- dim mode, 71
- DIRECT RPM, 162
- direct RPM input – F 48, 161
- direction of count, 5
- direction of travel, 50
- display
 - console, illustration, 4
 - dim OFF/ON – F 22/F 23, 71
 - dimming, 5
 - languages, 73
 - resolution, 5, 60
 - resolution options
 - in decimal degree mode, 68
 - in minutes and seconds mode, 69
 - test, 75
 - windows, 2
- dividing an axis value by 2, 32
- dividing values, 32
- DRO arm, 6
- DRO keypad, 148

E

earth ground, 6, 54

edge sensor

 connection, 3

 indicator, 56

 probe, 104, 105

 probe – F 09, 55

EDM display mode, 171

EDM features, 1, 167

EDM mode, 167

EDM setup, 170

EEProm test, 75

electronic notepad, 122

encoder resolution, 60, 62

encoder types, 61

end angle, 85

English, 73

ENTer key, 2

entering

 a datum, 108

 a datum (alternate method), 111

 axis dimensions, 123

 axis dimensions by teach-in, 126

 bolt-hole patterns in the electronic
 notepad, 127

 linear-hole patterns in the
 electronic notepad, 127

 target Z-depth and spark-out time –
 F 37, 181

error-checking capability, 74

establishing part zero, 20

even parity, 144

EverTrack mode settings, 65

EverTrack™ mode, 65

EverTrack™ mode – F 02, 25

F

F 01, 23

F 02, 25

F 03, 37

F 04, 47

F 05, 35

F 06, 49

F 07, 51

F 08, 53

F 09, 55

F 10, 30

F 11, 30

F 14, 140

F 16, 21

F 17, 135

F 18, 120

F 19, 120

F 20, 60

F 21, 11

F 22, 71

F 23, 71

F 24, 72

F 25, 141

F 26, 57

F 27, 143

F 28, 146

F 29, 77

F 31, 114

F 32, 119

F 33, 139

F 34, 58

F 35, 118

F 37, 169, 181

F 38, 152, 169, 177

F 39, 152, 169, 179

F 40, 74

F 41, 74

F 42, 155

F 45, 75

F 46, 169, 171

F 48, 161

F 50, 164
F 60, 149
F 61, 150
F 62, 151
F 63, 134
F 80, 24, 39
F 81, 24, 39, 46
F 90, 24
F 96, 156, 157
F 97, 156, 158
F 98, 156, 159
F 99, 73
factory settings, 5
feedrate on/off – F 26, 57
first spark detection, 171
first spark detection setup, 167
first spark detection setup – F 46,
169, 171
frame-hole pattern, 93, 94
frame-hole patterns, 122
frame-hole/linear-hole patterns, 78
French, 73
full bolt-hole pattern, 80, 81, 86
function code list, 8
Function key, 2

G

German, 73
ground, 6
ground connection, 3
ground wire, 54

H

help, 78

I

/O inputs connection, 3
I/O option, 167
I/O outputs connection, 3

inch linear encoders, 66
inch/metric conversion, 13
inch-based linear encoders, 60, 61
incremental moves, 16
input connections, 138
input voltage switch, 6
input/output module (I/O), 1
inserting, a line in the electronic
notepad, 132
internal counters, 75
internal EEPROM, 75
introducing, the Wizard, 1
Italian, 73

J

job clock ON/OFF – F 34, 58

K

key functions for compensation table,
44
keyboard, 75
keyboard entry error, 12
keyboard test, 76
keypad, 2
keys, 2

L

language, selection, 73
last position save/recall – F 10/F 11,
30
lathe mode, 107
line count, 67
linear encoder
connections, illustration, 3
error check, 183
miscounts, 74
resolution, 5
setting, 65
type, 62

- linear inaccuracies, 37
- linear-hole pattern, 93
- linear-hole patterns, 122
- linear-hole/frame-hole patterns, 78

M

- machine home, 25
- making, incremental moves, 20
- making, multiple moves of the same dimension, 18
- manual first spark detection, 171, 173
- manual format, 7
- material shrinkage/expansion, 37
- maximum, electrode depth, 181
- maximum, spindle speed, 161
- measure, the axis, 39
- message window, 2
- metric linear encoders, 60, 61, 62
- mill/lathe setup (900 only) –F 29, 77
- mill/lathe/EDM operation, 5
- mirror image – F 17, 135
- MM/INCH key, 2
- modify tool offset, 118

N

- no first spark detection, 171
- No First Spark Detection, 172
- no parity, 144
- numeric keys, 2

O

- odd parity, 144
- on/off switch, 3
- one-line recall mode, 17
- output connections, 137
- output test – F 42, 155

P

- parameter setting for spindle speed display, 165
- parameter settings – F 20, 25, 60
- parity, 143, 148
- parity options, 144
- part zero, 23
- partial bolt-hole pattern, 80, 82
- pin assignments
 - DA 15 connector, 137
 - DE 9 connector (male), 138
- plus/minus (\pm) key, 15
- plus/minus key, 2
- Portuguese, 73
- position tolerance indicator, 5
- power
 - cord, 183
 - cord, connection, 3
 - loss, 18
- preset values, 5
- presetting, a dimension, 17
- print program to external printer – F 62, 151
- printer output, 143
- printer output options, 145
- printing axis values, 147
- probe cable, 54

Q

- quick positioning, 21

R

- radius mode, 35
- radius/diameter mode, 5
- radius/diameter per axis – F 05, 35
- radius-diameter mode indicator, 35
- RBM-T linear encoders, 25
- RBS-T linear encoders, 25
- RCL key, 90

recall
 a dimension, 18
 datum, 113
 key, 90
 last position, 30
 program from external device –
 F61, 150
 tool offset, 117
ReCaLI key, 2
recalling
 a bolt-hole pattern, 90
 a linear-hole pattern, 98
 a part zero position, 28
 a preset dimension, 18
 dimensions from the electronic
 notepad, 129
reference indicator (RI), 25
referenced display, mode, 39
relay 1, 137, 169, 171, 173, 174,
 176, 177
RELAY 1, 155
relay 1 setup – F 38, 152
relay 2, 137, 169, 171, 174, 176,
 179, 180
RELAY 2, 155
relay 2 (spark-out/SparkArrest™)
 setup, 179, 180
relay 2 setup – F 39, 152
remote operation, 148
resetting
 absolute zero, 18
 an axis to zero, 20
 parameters to factory settings, 70
resolution, 5
rotary encoder, 1, 60, 61, 67, 165
round spring clip, 54
RS-232
 connection, 3
 interface, 148

 interface connector, pin
 assignments, 142
 ON/OFF – F 28, 146
 setup – F 27, 143
RST symbol, 21, 22

S

scrolling, 15
select axis for recall – F 63, 134
select language – F 99, 73
selecting, direction of movement, 55
send program to external device –
 F 60, 149
SET key, 2
setting
 a correction factor – F 03, 37
 a part zero - all axes, 26
 a part zero - one axis, 25
 display resolution (display degrees
 in decimal mode), 68
 display resolution (INCH mode), 64
 display resolution (MM mode), 63
 encoder resolution, 63, 66
 EverTrack™ mode, 65
 up encoder parameters, 60, 62
skew compensation, 78, 103
Spanish, 73
SPARK AUTO, 171, 175
spark cycle, 1
spark detection options, 171
spark erosion axis, 167
SPARK MAN, 171, 173
SPARK OFF, 172
spark out, 1
SparkArrest™, 1, 167, 169, 171, 174,
 176, 179, 180
SPARK-OFF, 171
spark-out, 167, 169, 171
spark-out cycle, 174, 176, 181

spark-out time, 169, 177, 179
spindle speed, 157
spindle speed display (SSD), 1
SSD option, 165
subtracting values, 15
Swedish, 73
system diagnostic tests, 75, 183

T

taper calculation, 78
taper calculator, 101
target Z-depth, 169, 173, 176, 177,
179, 181
teach-In, 126
temporary datum while in
EverTrack™ mode, 26
tool offset
clear – F 32, 119
key, 2, 107, 115
modify – F 35, 118
troubleshooting, 183
turning the machine OFF, 30

W

warranty, iii
W ZERO OUT, 155
Wizard 900 DRO, 1, 2
Wizard 900E, 167
Wizard 900E DRO, 1, 2

X

X ZERO OUT, 155

Y

Y ZERO OUT, 155

Z

Z depth guard, 171
Z ZERO OUT, 155
Z-depth guard, 167, 169
zero output
ON/OFF – F 33, 139, 141
time select – F 25, 141
time settings, list, 141
zero position, 171

ANILAM

U.S.A.

ANILAM
One Precision Way
Jamestown, NY 14701
☎ (716) 661-1899
☎ (716) 661-1884
✉ anilaminc@anilam.com

ANILAM, CA

16312 Garfield Ave., Unit B
Paramount, CA 90723
☎ (562) 408-3334
☎ (562) 634-5459
✉ anilamla@anilam.com

**Dial "011" before each number
when calling from the U.S.A.**

China

Acu-Rite Companies Inc.
(Shanghai Representative Office)
Room 1986, Tower B
City Center of Shanghai
No. 100 Zunyi Lu Road
Chang Ning District
200051 Shanghai P.R.C.
☎ +86 21 62370398
☎ +86 21 62372320
✉ china@anilam.com

France

ANILAM S.A.R.L.
2 Ave de la Cristallerie
B.P. 68-92316
Sevres Cedex, France
☎ +33-1-46290061
☎ +33-1-45072402
✉ courrier@acu-rite.fr

P/N 70000423B
6-February-04

Germany

ANILAM GmbH
Fraunhoferstrasse 1
D-83301 Traunreut
Germany
☎ +49 8669 856110
☎ +49 8669 850930
✉ info@anilam.de

Italy

ANILAM Elettronica s.r.l.
10043 Orbassano
Strada Borgaretto 38
Torino, Italy
☎ +39 011 900 2606
☎ +39 011 900 2466
✉ info@anilam.it

Taiwan

ANILAM, TW
No. 246 Chau-Fu Road
Taichung City 407
Taiwan, ROC
☎ +886-4 225 87222
☎ +886-4 225 87260
✉ anilamtw@anilam.com

United Kingdom

ACI (UK) Limited
16 Plover Close, Interchange Park
Newport Pagnell
Buckinghamshire, MK16 9PS
England
☎ +44 (0) 1908 514 500
☎ +44 (0) 1908 610 111
✉ sales@aciuk.co.uk

SALES & SERVICE:

A Tech Authority, Inc.

13745 Stockton Ave.
Chino CA 91710
909-614-4522
sales@atechauthority.com